



# Built-In Advantium® Electric Combination Wall Oven

Safety Information ..... 2

Warranty ..... 6

Assistance / Accessories ..... 7

**Using The Oven**

Oven Controls ..... 8

Special Features ..... 10

Oven Racks and Rack Positions ... 11

Cookware ..... 12

Cooking Modes ..... 13

Cooking Guide ..... 14

**Care and Cleaning**

Control Panel ..... 15

Oven Exterior ..... 15

Stainless Steel Surfaces ..... 15

Oven Interior ..... 15

Oven Racks ..... 16

Maintenance ..... 17

Troubleshooting Tips ..... 18

## Owner's Manual

PT9800 - 30" Double Wall Oven  
CT9800 - 30" Double Wall Oven

*For a Spanish version of this manual, visit our Website at [GEAppliances.com](http://GEAppliances.com).*

*Para consultar una versión en español de este manual de instrucciones, visite nuestro sitio de internet [GEAppliances.com](http://GEAppliances.com).*

Write the model and serial numbers here:

Model # \_\_\_\_\_

Serial # \_\_\_\_\_

You can find them on a label on the side trim or on the front of the (lower) oven behind the oven door.



Printed on Recycled Paper

## IMPORTANT SAFETY INFORMATION. READ ALL INSTRUCTIONS BEFORE USING.

### FEDERAL COMMUNICATIONS COMMISSION RADIO FREQUENCY INTERFERENCE STATEMENT (U.S.A. ONLY)

**⚠ WARNING** This equipment generates and uses ISM frequency energy and if not installed and used properly, that is in strict accordance with the manufacturer's instructions, may cause interference to radio and television reception. It has been type tested and found to comply with limits for an ISM Equipment pursuant to part 18 of FCC Rules, which are designed to provide reasonable protection against such interference in a residential installation. However, there is no guarantee that interference will not occur in a particular installation. If this equipment does cause interference to radio or television reception, which can be determined by turning the equipment off and on, the user is encouraged to try to correct the interference by one or more of the following:

- Reorient the receiving antenna of radio or television.
- Relocate the Microwave oven with respect to the receiver.
- Move the microwave oven away from the receiver.
- Plug the microwave oven into a different outlet so that microwave oven and receiver are on different branch circuits.

**The manufacturer** is not responsible for any radio or TV interference caused by **unauthorized modification** to this microwave oven. It is the responsibility of the user to correct such interference.

# IMPORTANT SAFETY INSTRUCTIONS

Upper Oven

## ***PRECAUTIONS TO AVOID POSSIBLE EXPOSURE TO EXCESSIVE MICROWAVE ENERGY***

- (a) **Do Not Attempt** to operate this oven with the door open since open-door operation can result in harmful exposure to microwave energy. It is important not to defeat or tamper with the safety interlocks.
- (b) **Do Not Place** any object between the oven front face and the door or allow soil or cleaner residue to accumulate on sealing surfaces.
- (c) **Do Not Operate** the oven if it is damaged. It is particularly important that the oven door close properly and that there is no damage to the:
- (1) door (bent),
  - (2) hinges and latches (broken or loosened),
  - (3) door seals and sealing surfaces.
- (d) **The Oven Should Not** be adjusted or repaired by anyone except properly qualified service personnel.

**▲ WARNING!** *To reduce the risk of burns, electric shock, fire, injury to persons or exposure to excessive microwave energy:*

## ***SAFETY PRECAUTIONS***

- Read all instructions before using this appliance. When using electrical appliances, basic safety precautions should be followed, including the following:
- Read and follow the specific precautions in the *PRECAUTIONS TO AVOID POSSIBLE EXPOSURE TO EXCESSIVE MICROWAVE ENERGY* section on page 2.
- Be sure your appliance is properly installed and grounded by a qualified technician in accordance with the provided installation instructions.
- Install or locate this appliance only in accordance with the provided installation instructions.
- Some products such as whole eggs and sealed containers—for example, closed jars—are able to explode and should not be heated in this oven. Such use of the oven could result in injury.
- Do not mount this appliance over a sink.
- Do not store anything directly on top of this appliance surface when this appliance is in operation.
- This oven is not approved or tested for marine use.
- This oven is UL listed for standard wall installation.
- Do not operate this appliance if it has been damaged or dropped.
- As with any appliance, close supervision is necessary when used by children.
- Use this appliance only for its intended use as described in this manual.
- Do not use corrosive chemicals or vapors in this appliance.
- This oven is specifically designed to heat, dry or cook food and is not intended for laboratory or industrial use.
- This appliance must only be serviced by qualified service personnel. Contact nearest authorized service facility for examination, repair or adjustment.
- Do not cover or block any openings on the appliance.
- Do not store this appliance outdoors. Do not use this product near water—for example, in a wet basement, near a swimming pool, near a sink or in similar locations.
- See door surface cleaning instructions in the *Care and Cleaning of the Oven* section of this manual.
- To reduce the risk of fire in the oven cavity:
  - Do not overcook food. Carefully attend appliance when paper, plastic or other combustible materials are placed inside the oven while microwave cooking.
  - Remove wire twist-ties and metal handles from paper or plastic containers before placing them in the oven.
  - Do not use the oven for storage purposes. Do not leave paper products, cooking utensils or food in the oven when not in use.
  - If materials inside the oven ignite, keep the oven door closed, turn the oven off and shut off power at the fuse or circuit breaker panel. If the door is opened, the fire may spread.
  - Do not use the Sensor Features twice in succession on the same food portion. If food is undercooked after the first countdown, use COOK BY TIME for additional cooking time.

***SAVE THESE INSTRUCTIONS***

# IMPORTANT SAFETY INSTRUCTIONS

Upper Oven

## **▲ WARNING!**

### **SAFETY PRECAUTIONS**

- Do not operate the oven without the turntable in place. The turntable must be unrestricted so it can turn.
- Potentially hot surfaces include the oven door, floor, walls, oven rack and turntable.

## **ARCING**

*Arcing can occur during both speedcooking and microwave cooking. If you see arcing, press the CANCEL/OFF pad and correct the problem.*

Arcing is the microwave term for sparks in the oven. Arcing is caused by:

- Metal or foil touching the side of the oven.
- Foil not molded to food (upturned edges act like antennas).
- Use foil only as recommended in this manual.
- Metal cookware used during either speedcook or microwave cooking (except for the pans provided with the oven).
- Metal, such as twist-ties, poultry pins, or gold-rimmed dishes, in the oven.
- Recycled paper towels containing small metal pieces being used in the oven.

## **FOODS**

- When microwaving, place all foods and containers on the clear glass tray.
- Do not pop popcorn in your oven unless in a special microwave popcorn accessory or unless you use popcorn labeled for use in microwave ovens.
- Do not boil eggs in this oven. Pressure will build up inside egg yolk and will cause it to burst, possibly resulting in injury.
- Do not operate the oven without food inside. This may cause damage to the oven. It increases the heat around the magnetron and can shorten the life of the oven.
- Foods with unbroken outer "skin" such as potatoes, hot dogs, sausages, tomatoes, apples, chicken livers and other giblets, and egg yolks should be pierced to allow steam to escape during cooking.

### **■ SUPERHEATED WATER**

*Liquids, such as water, coffee or tea, are able to be overheated beyond the boiling point without appearing to be boiling. Visible bubbling or boiling when the container is removed from the microwave oven is not always present. THIS COULD RESULT IN VERY HOT LIQUIDS SUDDENLY BOILING OVER WHEN THE CONTAINER IS DISTURBED OR A SPOON OR OTHER UTENSIL IS INSERTED INTO THE LIQUID.*

To reduce the risk of injury to persons:

- Do not overheat the liquid.
- Stir the liquid both before and halfway through heating it.
- Do not use straight-sided containers with narrow necks.
- After heating, allow the container to stand in the microwave oven for a short time before removing the container.
- Use extreme care when inserting a spoon or other utensil into the container.

**SAVE THESE INSTRUCTIONS**

# IMPORTANT SAFETY INSTRUCTIONS

Upper Oven

## ▲ **WARNING!**

### *Speedcook oven-safe cookware*

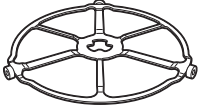

The **turntable** must always be in place when using the oven.



Put food directly on the **non-stick metal tray** to speedcook.

- The oven and door will get very hot when speedcooking.
- Cookware will become hot because of heat transferred from the heated food. Oven mitts will be needed to handle the cookware.
- Do not use coverings, containers or cooking/roasting bags made of foil, plastic, wax or paper when speedcooking.
- Do not cover the turntable, wire oven rack, trays or any part of the oven with metal foil. This will cause arcing in the oven.
- Use the nonstick metal tray in the same way you would use a shallow baking pan or baking tray.
- Place food directly on the trays when cooking unless prompted by the oven to do otherwise.
- Any oven-safe dish can be used in your oven. Recipes in the Advantium Cookbook were tested in Pyrex® glass cookware and Corningware® ceramic casseroles. Cook times and results may vary when using other types of oven-safe dishes. Place them directly on the trays.
- Do not use the oven to dry newspapers.
- Use of the clear glass tray when speedcooking will result in inferior cooking performance.

### *Oven-safe cookware for Baking, Broiling, Warming, Proofing & Toasting*

- The oven and door will get very hot when baking, broiling, warming, proofing or toasting.
- Cookware will become hot. Oven mitts will be needed to handle the cookware.
- Do not use coverings, containers or cooking/roasting bags made of foil, plastic, wax or paper when speedcooking.
- Do not cover the turntable, wire oven rack, trays or any part of the oven with metal foil. This will cause arcing in the oven.
- Use the non-stick metal tray in the same way you would use a shallow baking pan or baking tray.
- Use the aluminum baking sheet on the wire oven rack, and place them on the non-stick metal tray when baking on two levels, broiling or toasting foods.
- Place food directly on the trays when cooking unless prompted by the oven to do otherwise.
- Any oven-safe dish can be used in your oven. Recipes in the Advantium Cookbook were tested in Pyrex® glass cookware and Corningware® ceramic casseroles. Cook times and results may vary when using other types of oven-safe dishes. Place them directly on the trays.
- Do not use the oven to dry newspapers.
- Use of the clear glass tray when baking, broiling, warming, proofing or toasting will result in inferior cooking performance.

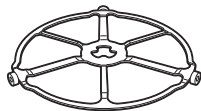

The **turntable** must always be in place when using the oven.



Put food directly on the **non-stick metal tray** to bake on one level.



Put food directly on the aluminum baking sheet on the wire oven rack, and place them on the non-stick metal tray, when baking on two levels, broiling or toasting foods.

## SAVE THESE INSTRUCTIONS

# IMPORTANT SAFETY INSTRUCTIONS

Upper Oven

## ⚠ WARNING!

### Microwave-safe cookware

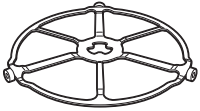

The **turntable** must always be in place when using the oven.

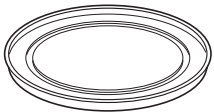

The **clear glass tray** should always be in place when microwaving.

Make sure to use suitable cookware during microwave cooking. Most glass casseroles, cooking dishes, measuring cups, custard cups, pottery or china dinnerware which does not have metallic trim or glaze with a metallic sheen can be used. Some cookware is labeled "suitable for microwaving."

- Place food or microwavable container directly on the clear glass tray to cook your food.
- Use of the non-stick metal tray during microwave cooking will result in inferior cooking performance.

- If you are not sure if a dish is microwave-safe, use this test: Place in the oven both the dish you are testing and a glass measuring cup filled with 1 cup of water—set the measuring cup either in or next to the dish. Microwave 30-45 seconds at high. If the dish heats, it should not be used for microwaving.



How to test for a microwave-safe dish.

- If the dish remains cool and only the water in the cup heats, then the dish is microwave-safe.
- Cookware may become hot because of heat transferred from the heated food. Oven mitts may be needed to handle the cookware.
- Do not use recycled paper products. Recycled paper towels, napkins and waxed paper can contain metal flecks which may cause arcing or ignite. Paper products containing nylon or nylon filaments should be avoided, as they may also ignite.
- Use foil only as directed in this manual. When using foil in the oven, keep the foil at least 1" away from the sides of the oven.
- Do not use the oven to dry newspapers.
- If you use a meat thermometer while cooking, make sure it is safe for use in microwave ovens.

- Some foam trays (like those that meat is packaged on) have a thin strip of metal embedded in the bottom. When microwaved, the metal can burn the floor of the oven or ignite a paper towel.
- Paper towels, waxed paper and plastic wrap can be used to cover dishes in order to retain moisture and prevent spattering. Be sure to vent plastic wrap so steam can escape.
- Not all plastic wrap is suitable for use in microwave ovens. Check the package for proper use.
- "Boilable" cooking pouches and tightly closed plastic bags should be slit, pierced or vented as directed by package. If they are not, plastic could burst during or immediately after cooking, possibly resulting in injury. Also, plastic storage containers should be at least partially uncovered because they form a tight seal. When cooking with containers tightly covered with plastic wrap, remove covering carefully and direct steam away from hands and face.
- Plastic cookware—Plastic cookware designed for microwave cooking is very useful, but should be used carefully. Even microwave-safe plastic may not be as tolerant of overcooking conditions as are glass or ceramic materials and may soften or char if subjected to short periods of overcooking. In longer exposures to overcooking, the food and cookware could ignite.

Follow these guidelines:

1. Use microwave-safe plastics only and use them in strict compliance with the cookware manufacturer's recommendations.
2. Do not microwave empty containers.
3. Do not permit children to use plastic cookware without complete supervision.

## SAVE THESE INSTRUCTIONS



# IMPORTANT SAFETY INSTRUCTIONS

---

Upper Oven

---

## **▲ WARNING!**

### *SAFETY PRECAUTIONS*

- Don't defrost frozen beverages in narrow-necked bottles (especially carbonated beverages). Even if the container is open, pressure can build up. This can cause the container to burst, possibly resulting in injury.
- Foods cooked in liquids (such as pasta) may tend to boil more rapidly than foods containing less moisture. Should this occur, refer to the *Care and Cleaning of the oven* section for instructions on how to clean the inside of the oven.
- Hot foods and steam can cause burns. Be careful when opening any containers of hot food, including popcorn bags, cooking pouches and boxes. To prevent possible injury, direct steam away from hands and face.
- Do not overcook potatoes. They could dehydrate and catch fire, causing damage to your oven.
- Avoid heating baby food in glass jars, even with the lid off. Make sure all infant food is thoroughly cooked. Stir food to distribute the heat evenly. Be careful to prevent scalding when warming formula. The container may feel cooler than the formula really is. Always test the formula before feeding the baby.
- Do not attempt to deep fry in the oven.

---

### *Notice— Pacemakers*

- Most pacemakers are shielded from interference from electronic products, including microwaves. However, patients with pacemakers may wish to consult their physicians if they have concerns.

## *SAVE THESE INSTRUCTIONS*

# IMPORTANT SAFETY INFORMATION. READ ALL INSTRUCTIONS BEFORE USING.

*Lower Oven*

## **▲ WARNING**

Read all safety instructions before using the product. Failure to follow these instructions may result in fire, electrical shock, serious injury or death.

## STATE OF CALIFORNIA PROPOSITION 65 WARNING

The California Safe Drinking Water and Toxic Enforcement Act requires the Governor of California to publish a list of substances known to the state to cause cancer, birth defects or other reproductive harm, and requires businesses to warn customers of potential exposure to such substances.

## **▲ WARNING**

This product contains one or more chemical known to the State of California to cause cancer, birth defects or other reproductive harm.

Self-clean ovens can cause low-level exposure to some of these substances, including carbon monoxide, during the cleaning cycle. Exposure can be minimized by venting with an open window or using a ventilation fan or hood.

## **▲ WARNING**

## GENERAL SAFETY INSTRUCTIONS

- Use this appliance only for its intended purpose as described in this Owner's Manual.
- Be sure your appliance is properly installed and grounded by a qualified installer in accordance with the provided installation instructions.
- Do not attempt to repair or replace any part of your oven unless it is specifically recommended in this manual. All other servicing should be transferred to a qualified technician.
- Before performing any service, disconnect the power supply at the household distribution panel by removing the fuse or switching off the circuit breaker.
- Do not leave children alone—children should not be left alone or unattended in an area where an appliance is in use. They should never be allowed to climb, sit or stand on any part of the appliance.
- **▲ CAUTION:** Do not store items of interest to children in cabinets above an oven - children climbing on the oven to reach items could be seriously injured.
- Use only dry pot holders—moist or damp pot holders on hot surfaces may result in burns from steam. Do not let pot holders touch hot heating elements. Do not use a towel or other bulky cloth in place of pot holders.
- Never use your appliance for warming or heating the room.
- Do not touch the heating elements or the interior surface of the oven. These surfaces may be hot enough to burn even though they are dark in color. During and after use, do not touch, or let clothing or other flammable materials contact any interior area of the oven; allow sufficient time for cooling first. Other surfaces of the appliance may become hot enough to cause burns. Potentially hot surfaces include the oven vent opening, surfaces near the opening and crevices around the oven door.
- Do not heat unopened food containers. Pressure could build up and the container could burst, causing an injury.
- Do not use any type of foil or liner to cover the oven bottom or anywhere in the oven, except as described in this manual. Oven liners can trap heat or melt, resulting in damage to the product and risk of shock, smoke or fire.
- Avoid scratching or impacting glass doors or control panels. Doing so may lead to glass breakage. Do not cook on a product with broken glass. Shock, fire or cuts may occur.
- Cook meat and poultry thoroughly—meat to at least an internal temperature of 160°F and poultry to at least an internal temperature of 180°F. Cooking to these temperatures usually protects against foodborne illness.

## SAVE THESE INSTRUCTIONS



**⚠ WARNING****KEEP FLAMMABLE MATERIALS AWAY FROM THE OVEN**

Failure to do so may result in fire or personal injury.

- Do not store or use flammable materials in or near an oven, including paper, plastic, pot holders, linens, wall coverings, curtains, drapes and gasoline or other flammable vapors and liquids.
- Never wear loose-fitting or hanging garments while using the appliance. These garments may ignite if they contact hot surfaces, causing severe burns.
- Do not let cooking grease or other flammable materials accumulate in or near the oven. Grease in the oven or near the oven may ignite.

**⚠ WARNING****IN THE EVENT OF A FIRE, TAKE THE FOLLOWING STEPS TO PREVENT INJURY AND FIRE SPREADING**

- Do not use water on grease fires. Never pick up a flaming pan.
- If there is a fire in the oven during baking, smother the fire by closing the oven door and turning the oven off or by using a multi-purpose dry chemical or foam-type fire extinguisher.
- If there is a fire in the oven during self-clean, turn the oven off and wait for the fire to go out. Do not force the door open. Introduction of fresh air at self-clean temperatures may lead to a burst of flame from the oven. Failure to follow this instruction may result in severe burns.

**⚠ WARNING****OVEN SAFETY INSTRUCTIONS**

- Stand away from the oven when opening the oven door. Hot air or steam which escapes can cause burns to hands, face and/or eyes.
- Keep the oven vent unobstructed.
- Keep the oven free from grease buildup. Grease in the oven may ignite.
- Place oven racks in desired location while oven is cool. If rack must be moved while oven is hot, do not let pot holder contact hot heating element in oven.
- When using cooking or roasting bags in the oven, follow the manufacturer's directions.
- Pulling out the standard racks to their stop-locks or the extension rack to its fully open position is a convenience in lifting heavy foods. It is also a precaution against burns from touching hot surfaces of the door or oven walls.
- Do not leave items such as paper, cooking utensils or food in the oven when not in use. Items stored in an oven can ignite.
- Never place cooking utensils, pizza or baking stones, or any type of foil or liner on the oven floor. These items can trap heat or melt, resulting in damage to the product and risk of shock, smoke or fire.

**⚠ WARNING****SELF-CLEANING OVEN SAFETY INSTRUCTIONS**

The self-cleaning feature operates the oven at temperatures high enough to burn away food soils in the oven. Follow these instructions for safe operation.

- Do not touch oven surfaces during self-clean operation. Keep children away from the oven during self-cleaning. Failure to follow these instructions may cause burns.
- Before self-cleaning the oven, remove shiny silver colored oven racks (on some models), the probe, any aluminum foil, and any broiler pan, grid, and other cookware. Only porcelain coated oven racks may be left in the oven.
- Before operating the self-clean cycle, wipe grease and food soils from the oven. Excessive amount of grease may ignite, leading to smoke damage to your home.
- If the self-cleaning mode malfunctions, turn the oven off and disconnect the power supply. Have it serviced by a qualified technician.
- Do not clean the door gasket. The door gasket is essential for a good seal. Care should be taken not to rub, damage or move the gasket.
- Do not use oven cleaners. No commercial oven cleaner or oven liner protective coating of any kind should be used in or around any part of the oven.

**SAVE THESE INSTRUCTIONS**

# Notes

---

# Thank You! ... for your purchase of a GE Brand appliance.

**Register Your Appliance:** Register your new appliance on-line at your convenience!

[www.geappliances.com/service\\_and\\_support/register/](http://www.geappliances.com/service_and_support/register/)

Timely product registration will allow for enhanced communication and prompt service under the terms of your warranty, should the need arise. You may also mail in the pre-printed registration card included in the packing material.

## GE Electric Range Warranty

### GEAppliances.com

All warranty service is provided by our Factory Service Centers, or an authorized Customer Care® technician. To schedule service, on-line, visit us at [www.geappliances.com/service\\_and\\_support/](http://www.geappliances.com/service_and_support/), or call 800.GE.CARES (800.432.2737). Please have serial number and model number available when calling for service.

Servicing your appliance may require the use of the onboard data port for diagnostics. This gives a GE factory service technician the ability to quickly diagnose any issues with your appliance and helps GE improve its products by providing GE with information on your appliance. If you do not want your appliance data to be sent to GE, please advise your technician not to submit the data to GE at the time of service.

For the period of one year from the date of the original purchase. GE will provide any part of the range which fails due to a defect in materials or workmanship. During this limited one-year warranty, GE will also provide, free of charge, all labor and in-home service to replace the defective part.

### What GE will not cover:

- Service trips to your home to teach you how to use the product.
- Improper installation, delivery or maintenance.
- Failure of the product if it is abused, misused, modified or used for other than the intended purpose or used commercially.
- Replacement of house fuses or resetting of circuit breakers.
- Damage to the product caused by accident, fire, floods or acts of God.
- Incidental or consequential damage caused by possible defects with this appliance.
- Damage caused after delivery.
- Product not accessible to provide required service.
- Service to repair or replace light bulbs, except for LED lamps.

### EXCLUSION OF IMPLIED WARRANTIES

Your sole and exclusive remedy is product repair as provided in this Limited Warranty. Any implied warranties, including the implied warranties of merchantability or fitness for a particular purpose, are limited to one year or the shortest period allowed by law.

This warranty is extended to the original purchaser and any succeeding owner for products purchased for home use within the USA. If the product is located in an area where service by a GE Authorized Servicer is not available, you may be responsible for a trip charge or you may be required to bring the product to an Authorized GE Service location for service. In Alaska, the warranty excludes the cost of shipping or service calls to your home.

Some states do not allow the exclusion or limitation of incidental or consequential damages. This warranty gives you specific legal rights, and you may also have other rights which vary from state to state. To know what your legal rights are, consult your local or state consumer affairs office or your state's Attorney General.

**Warrantor:** General Electric Company. Louisville, KY 40225

**Extended Warranties:** Purchase a GE extended warranty and learn about special discounts that are available while your warranty is still in effect. You can purchase it on-line anytime

[www.geappliances.com/service\\_and\\_support/shop-for-extended-service-plans.htm](http://www.geappliances.com/service_and_support/shop-for-extended-service-plans.htm)

or call 800.626.2224 during normal business hours. GE Consumer Home Services will still be there after your warranty expires.

Staple your receipt here. Proof of the original purchase date is needed to obtain service under the warranty.

# Have a question or need assistance with your appliance?

Try the GE Appliances Website ([www.geappliances.com/service\\_and\\_support/](http://www.geappliances.com/service_and_support/)) 24 hours a day, any day of the year! For greater convenience and faster service, you can now download Owner's Manuals, order parts or even schedule service on-line.

**Schedule Service:** Expert GE repair service is only one step away from your door. Get on-line and schedule your service at [www.geappliances.com/service\\_and\\_support/](http://www.geappliances.com/service_and_support/) Or call 800.GE.CARES (800.432.2737) during normal business hours.

**Parts and Accessories:** Individuals qualified to service their own appliances can have parts or accessories sent directly to their homes (VISA, MasterCard and Discover cards are accepted). Order on-line today, 24 hours every day or by phone at 800.626.2002 during normal business hours.

Instructions contained in this manual cover procedures to be performed by any user. Other servicing generally should be referred to qualified service personnel. Caution must be exercised, since improper servicing may cause unsafe operation.

**Real Life Design Studio:** GE supports the Universal Design concept of products, services and environments that can be used by people of all ages, sizes and capabilities. We recognize the need to design for a wide range of physical and mental abilities and impairments. For details of GE's Universal Design applications, including kitchen design ideas for people with disabilities, check out our Website today. For the hearing impaired, please call 800.TDD.GEAC (800.833.4322).

**Contact Us:** If you are not satisfied with the service you receive from GE, contact us on our Website with all the details including your phone number, or write to:  
**General Manager, Customer Relations**  
**GE Appliances, Appliance Park Louisville, KY 40225**

## Accessories

Looking For Something More?

GE offers a variety of accessories to improve your cooking and maintenance experiences!

To place an order visit us online at:

[www.GEApplianceParts.com](http://www.GEApplianceParts.com) (U.S.) or [www.GEAppliances.ca](http://www.GEAppliances.ca) (Canada)

or call **800.626.2002** (U.S.) **800.661.1616** (Canada)

The following products and more are available:

### Accessories

Small Broiler Pan (8 ¾" x 1 ¼" x 13 ½")	WB48X10055 (US) 222D2097G001 (Canada)
Large* Broiler Pan (12 ¾" x 1 ¼" x 16 ½")	WB48X10056 (US) 222D2097G002 (Canada)
XL** Broiler Pan (17" x 1 ¼" x 19 1/4")	WB48X10057 (US) Not available in Canada

### Parts

Oven racks	Part numbers vary by model
Oven elements	Part numbers vary by model
Light bulbs	Part numbers vary by model

### Cleaning Supplies

CitruShine Stainless Steel Wipes	WX10X10007
CeramaBryte Stainless Steel Appliance Cleaner	PM10X311
Graphite Lubricant	WB02T10303

\*The large broiler pan does not fit in 20"/24" ranges.

\*\*The XL broiler pan does not fit in 24" wall ovens, 27" drop ins or 20"/24" ranges

## How to Remove Protective Shipping Film and Packaging Tape

Carefully grasp a corner of the protective shipping film with your fingers and slowly peel it from the appliance surface. Do not use any sharp items to remove the film. Remove all of the film before using the appliance for the first time.

To assure no damage is done to the finish of the product, the safest way to remove the adhesive from

packaging tape on new appliances is an application of a household liquid dishwashing detergent. Apply with a soft cloth and allow to soak.

**NOTE:** The adhesive must be removed from all parts. It cannot be removed if it is baked on.

# Oven Controls

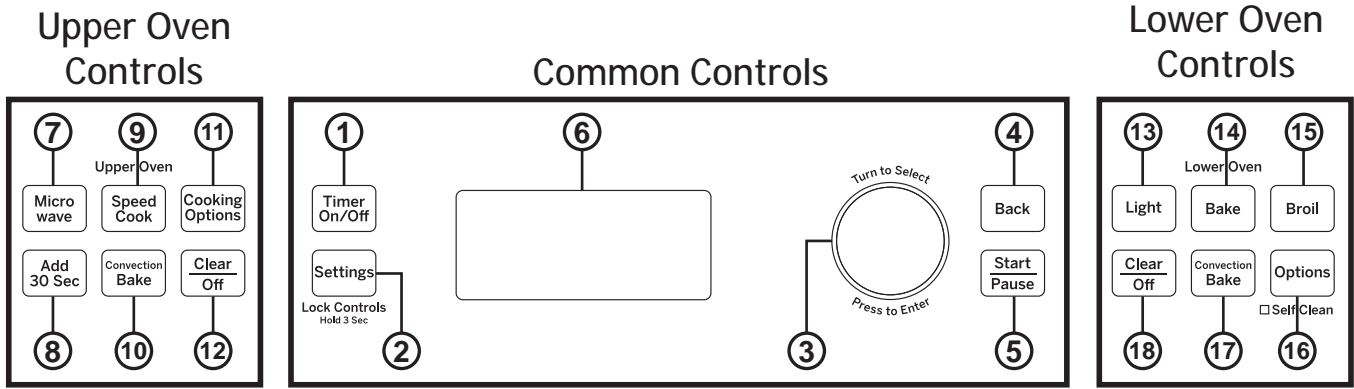

## Common Controls

- 1. Timer On/Off:** Works as a countdown timer. Press the **Timer On/Off** pad, select the timer type (hours and minutes or minutes and seconds), use the knob to set the time, and press the knob to start the timer countdown. The oven will continue to operate when the timer countdown is complete. To turn the timer off press the **Timer On/Off** pad.
- 2. Settings / Lock Controls:** Find oven options Help, Clock Settings, Display Mode, Auto Conversion, Auto Shut Off, Beeper Volume, Reminder, Temperature Units, Thermostat Adjust and Oven Information under this selection. See the Settings & Options section for more details. Press and hold **Settings** pad for 3 seconds to lock or unlock the controls. This locks out the control so that pressing any of the control pads does not activate the control. Cancel/Off is always active, even when the control is locked.
- 3. Knob:** Rotate this knob to select oven settings, upper and lower oven options and cooking options then press the knob to confirm the selection. Rotate the knob to increase or decrease temperatures or time and then press the knob to confirm the set temperature or time. This knob is used for both the upper and lower ovens.
- 4. Back:** Press this pad to go back a menu in the display.
- 5. Start/Pause:** Press the **Start/Pause** pad to start or pause any cooking, clean or timed function. Cannot pause lower oven cooking.
- 6. Display:** Information about both the upper and lower ovens are shown in this display window.

## Upper Oven Controls

- 7. Microwave:** Press the **Microwave** pad for microwaving options. Use the knob to find the microwaving option desired and press the knob to select it. Options available include Cook by Time, Cook, Defrost, Beverage, Popcorn, Melt, Reheat, Simmer and Soften. Use the clear glass tray and microwave-safe cookware when using the microwave features.
- 8. Add 30 Sec:** Press the **Add 30 Sec** pad for 30 seconds of microwave cooking time. Each time this pad is pressed an additional 30 seconds is added to the remaining cooking time. The oven starts immediately.

- 9. Speed Cook:** Press the **Speed Cook** pad to access the preset speed cook menu. Place food or oven-safe dish directly on the metal tray when using the speed cook feature. Do not use plastic or silicone cookware when using this feature since they could be melted or deformed.
- 10. Convection Bake:** Press the **Convection Bake** pad to convection bake in the upper oven. Place food or oven safe dish on the metal tray when using the convection bake feature. When convection baking on two levels, place food or oven safe dish on the aluminum baking sheet on the wire oven rack and place them on the metal tray.
- 11. Cooking Options:** Find features Repeat Last, Broil, Proof, Toast and Warm under this selection. See the Settings & Options section for more details.
- 12. Clear/Off:** The Clear/Off pad cancels ALL upper oven programs except the clock and timer.

## Lower Oven Controls

- 13. Light:** Turn the oven light on or off in the lower oven. Note that light in lower oven will not turn on if the door is opened while the other oven is in a clean mode.
- 14. Bake:** Press the **Bake** pad to bake, rotate knob to select baking temperature and press to select.
- 15. Broil:** Press the **Broil** pad to broil, rotate knob to select Hi/Lo and press to select.
- 16. Options:** Find features Delay Start, Probe, Proof, Sabbath, Self-Clean, Steam Clean and Warm under this selection. See the Settings & Options section for more details.
- 17. Convection Bake:** Convection cook modes use increased air circulation to improve performance. The type of benefit depends on the mode. Your lower oven has the following convection cooking modes: Convection Bake (1 Rack/Multi) and Convection Roast. See the Cooking Modes section for more information.
- 18. Clear/Off:** The Clear/Off pad cancels ALL lower oven programs except the clock and timer.



# Settings & Options

Lower Oven

There are several different special features on your wall oven. To change the settings of these special features, press the **BAKE** and **BROIL** pads at the same time and hold for three seconds. "SF" will appear in the display. Select the feature you want to change. When the change has been made, press the **START** key to save the change and return to the time of day.

## Adjust the Oven Temperature

This feature allows the oven baking and convection baking temperature to be adjusted up to 35°F hotter or down to 35°F cooler. Use this feature if you believe your oven temperature is too hot or too cold and wish to change it. **For double oven models, the upper and lower ovens are adjusted separately.** This adjustment affects Bake, and Convection Bake (1 Rack/Multi) modes. No other cooking modes are affected.

Press the **Bake** pad to select the oven to be adjusted. Press the **Bake** pad again to enter the temperature adjustment mode. A number between 35 and - 35 will display. Use the number pads to set the desired temperature adjustment and use the **Bake** pad to change between negative and positive.

Press the **Start** pad to save the temperature adjustment.

## End of Timer Signals

This is the tone that signals the end of a timer. The tone can be continuous (Con bEEP) or one repeating beep (bEEP). A continuous setting will continue to sound a tone until a button on the control is pressed. Press the **Broil** pad to view the current setting and then to change the setting.

## Fahrenheit or Celsius Temperature Display

The oven control is set to use Fahrenheit temperatures (F), but you can change it to use Celsius temperatures (C). Press the number **6** and **8** pads at the same time to view the current setting, press again to change the setting.

## Clock Display

This feature specifies how the time of day will be displayed or if no time of day will be displayed. You can select a standard 12-hour clock (12 H), 24-hour military time display (24 H), or for no clock displayed (oFF). Press the **Clock** pad to view the current setting, press again to change the setting.

## Auto Recipe Conversion

When using Convection Bake 1 Rack or Convection Bake Multi Rack cooking options, Auto Recipe Conversion will automatically convert the regular baking temperatures entered to convection bake cooking temperatures when turned on. Note that this option does not convert convection bake cooking times, it only converts temperatures. Press the **Convection Bake (1 Rack/Multi)** pad to view the conversion setting, press again to toggle between On (Con On) and Off (Con oFF).

## Sound Volume

This feature allows the oven tone volume to be adjusted between high (HI bEEP HI), medium (Std bEEP Std), low (Lo bEEP Lo) and off (oFF bEEP oFF). Press the number **1** and **5** pads at the same time to view the current setting or to change the setting. The control will sound the oven tone at the new volume level each time the sound level is changed.

## 12-hour auto shut-off and Sabbath

Options for this feature are "12 SHdn", "no SHdn" and "SAbbAtH".

12-hour auto shut-off turns off the oven after 12 hours of continuous operations.

Sabbath mode disables the oven lights (the oven light will not turn on when the door is opened), all sounds (the control will not beep when a button is pressed), Convection, Broil, Warm, Proof, Cook Time, Timer, Clock, and Delay Time functions. Sabbath mode can only be used with Bake. This feature conforms to the Star-K Jewish Sabbath requirements.

Press and hold the **Bake** and **Broil** pads for 3 seconds to enter special features.

Press the **Delay Time** pad to view the current setting and then to change the setting.

To use Sabbath mode, select "SAbbAtH" and press **Start**. A **J** will appear in the display and the clock will not display.

Note that if you have a double wall oven, when you place the control into Sabbath mode, both ovens are now in Sabbath mode and available for cooking.

Once in Sabbath mode, at any time you can press **Bake**, use the number pads to enter a temperature between 170F and 550F, and press **Start**. No sound will be given when the keys are pressed. At a random time between 30 seconds and 1 minute, **J**, will appear in the display indicating the oven is running.

Note that both ovens of a double wall oven can be used in Sabbath mode. Each oven can be programmed to a different temperature and each oven must be programmed separately.

If you need to adjust the temperature, press **Bake**, use the number pads to enter a new temperature between 170F and 550F, and press **Start**.

To turn the oven off, press **Cancel/Off** at any time. **The oven will immediately turn off** and **J** will change to **]** indicating that the oven has turned off.

Note that each oven of a double wall oven must be turned off separately.

To exit Sabbath mode, make sure that the oven is turned off. Press and hold the **Bake** and **Broil** pads for 3 seconds to enter special features then press **Delay Time** until either "12 SHdn" or "no SHdn" is in the display and press **Start**.

**NOTE:** If power outage occurs during Sabbath mode the unit will remain in Sabbath mode but off when power is restored.



## Settings & Options

---

### *Repeat last*

*Use this time saving feature for cooking repetitive items like cookies or appetizers.*

**NOTE:** *The last program used is stored for two hours.*

1. Press upper oven cook option and select repeat last.
2. The last preset food will be displayed.
3. Press the START/PAUSE pad or the selector dial to start cooking.

---

### *Resume feature*

1. If your food needs to cook a bit longer, you can restart the oven by pressing the START/PAUSE pad or selector dial.
2. **RESUME COOKING** will be displayed and the oven will restart immediately at 10% of the original time.

The program stays in memory for 5 minutes. After that you will need to begin the program again. See *To use a preset speedcook menu*.

# Speedcook Menu Guide

## Upper Oven

### Display prompts

After pressing the SPEEDCOOK pad, the oven will prompt you to make several selections, such as the example below.



**NOTE:** When speedcooking, use the metal tray.

1. Turn the dial until *FOOD MENU* appears. Press the dial to enter.
2. Turn the dial until *POULTRY* appears. Press the dial to enter.
3. Turn the dial until *CHICKEN, BONELESS* appears. Press the dial to enter.
4. Turn the dial to *Select SIZE: MEDIUM (7–9 oz each)*. Press the dial to enter.
5. Turn the dial to *Select amount: 1–2 pieces*. Press the dial to enter.
6. Use *METAL TRAY* is displayed.

### Preset speedcook menu selections

■ After a cooking cycle has been completed, use the Resume feature to cook for additional time.

■ To review settings during cooking, press the selector dial.

<i>Food Category</i>	<i>Menu Selection</i>	<i>Food Category</i>	<i>Menu Selection</i>
<i>Appetizers</i>	Bagel Bites Cheese Sticks Egg Rolls (Frozen) Hot Dip (2–4 Cups) Jalapeno Poppers Meat Balls (Frozen) Nachos Nuts Roasted Onion Rings Pizza Rolls Soft Pretzels (Frozen)	<i>Meats</i>	Filet Mignon Hamburger Lamb Chops Pork Chops Roast – Pork Roast – Beef Ribeye Steak Sirloin Steak Strip Steak T-Bone Steak Tenderloin
<i>Breads</i>	Bagels (frozen) Biscuits Bread Sticks Cheese Bread Crescent Rolls Dinner Rolls Garlic Bread Quick Bread (9x5) Sweet Rolls/Danish Taco Shells (boxed) Texas Toast	<i>Pizza</i>	Deli/Fresh Use Precooked Crust Frozen Pizza
<i>Breakfast</i>	Bagels (frozen) Belgian Waffles Breakfast Pizza Casserole (egg 7x11) Coffee Cake French Toast Pancakes (frozen) Hashbrown Patties Rolls (refrigerated) Sausage Biscuit Sausage Strudel (frozen) Sweet Rolls/Danish Turnovers Waffles (frozen)	<i>Potatoes</i>	Baked Potato Hashbrown Patties Frozen Fries Frozen Nugget Sweet Potato/Yam
<i>Desserts</i>	Brownies Cakes (mix 9x13) Cobbler (fresh 7x11) Coffee Cake Cookies Pie (fresh fruit) Rolls (refrigerated) Turnovers	<i>Poultry</i>	Chicken, Bone-In Chicken, Boneless Chicken Fillet (frozen) Chicken Finger (frozen) Chicken, Fried (frozen) Chicken Nugget (frozen) Chicken Patty (frozen) Chicken Tender (frozen) Chicken Wings (frozen) Chicken, Whole Turkey
<i>Entree</i>	Burritos (frozen) Chimichanga Casserole Egg Rolls (frozen) Enchilada (fresh) Lasagna Meatloaf (9x5) Quesadillas (fresh) Stuffed Peppers (6)	<i>Sandwich</i>	Corn Dog (frozen) Crescent Roll Hot Dog Grilled Sandwich Hot Dog in a Bun Pocket Sandwich Taquitos (frozen)
		<i>Seafood</i>	Cod Fillets Fish Sticks (frozen) Frozen Breaded Lobster Tails Orange Roughy Fillet Salmon Sea Bass Shellfish Swordfish Steak Tilapia Tuna Steaks Whitefish
		<i>Side Dish</i>	Refried Beans (16 oz) Roasted Asparagus Roasted Bell Pepper Roasted Chilis (6) Roasted Corn Roasted Garlic Roasted Mixed Vegetables Stuffing (mix) Stuffed Mushrooms Stuffed Tomatoes

Using speedcook features

**⚠ CAUTION:** When using speedcook programs, remember that the oven, door and dishes will be very hot!

**⚠ PRECAUCIÓN:** cuando utilice los programas de cocción rápida, recuerde que el horno, compuerta y los platos se encontrarán muy calientes!

Prior to the first use of your oven, the clock must be set.

Before you begin, make sure the turntable is in place. Use the nonstick metal tray and your own glass or ceramic cookware, if needed.

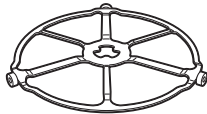

The turntable must always be in place when using the oven.



Put food directly on the non-stick metal tray to speedcook.

**SPEEDCOOK PRESET FOOD SELECTIONS:**

- |                     |                   |                   |                    |
|---------------------|-------------------|-------------------|--------------------|
| ■ <b>Appetizers</b> | ■ <b>Desserts</b> | ■ <b>Pizza</b>    | ■ <b>Sandwich</b>  |
| ■ <b>Breads</b>     | ■ <b>Entrees</b>  | ■ <b>Potatoes</b> | ■ <b>Seafood</b>   |
| ■ <b>Breakfast</b>  | ■ <b>Meats</b>    | ■ <b>Poultry</b>  | ■ <b>Side Dish</b> |

To use a preset speedcook menu

Upper oven is already pre-set to cook over 175 popular dishes.

1. Press the speedcook pad.  
*If no selection is made within 15 seconds, the display will revert back to the time of day.*
2. Turn the selector dial to select the type of food category you want. Press the dial to enter.
3. Turn the selector dial to select the specific food (menu selection). Press the dial to enter.
4. Turn the selector dial to select amount, size and/or doneness (if required, the oven will prompt you). Press the dial after each selection.

5. Once the display shows *EDIT* or *START*, either press start or the selector dial to start cooking.

*Turn the food over when the oven signals TURN FOOD OVER (for certain foods).*

*When the oven signals CHECK for DONENESS, check to see if your food is done to your liking (for certain foods).*

*To review settings during cooking, press the selector dial.*

*If you enter an undesired selection at any time, simply press the BACK pad and reenter the desired selections.*

- *Early in a speedcook program, you will see OPTIMIZING COOK TIME on the display. The oven automatically senses the electrical voltage level in your home and adjusts the cooking time up or down for proper cooking.*
- *If the door is opened during cooking, the oven will stop and PAUSE will appear in the display. Close the door and press the START/PAUSE pad to resume cooking.*
- *At anytime during cooking you can turn the selector dial to change the cooking time. You can change power levels by pressing the dial to edit setting.*
- *To assure consistent cooking results, the oven may adjust power levels downward if the oven is hot at the beginning of a program.*
- *At the end of cooking, the automatic fan may continue to run for a short time to cool internal components.*
- *To cook for additional time after a cooking cycle has been completed, use the resume feature.*

## Cooking tips for great tasting results

To ensure consistent and even browning when cooking foods directly on the metal tray, arrange food as shown below.

Foods can touch but should not overlap.

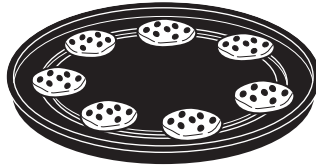

Circular pattern  
(Example: biscuits, cookies)



Side by side pattern  
(Example: meats and poultry)



Spoke pattern  
(Example: crescent rolls, breadsticks)



Single layer  
(Example: appetizers)

Fresh meat, chicken, fish or seafood that has been frozen should be **thawed before cooking** (the microwave defrost feature can be used). For other frozen prepackaged foods, follow package directions.

## *Speedcook power level*

Upper oven uses power from a high-intensity halogen light, ceramic heaters and microwaves to cook food from the top, bottom and interior simultaneously to seal in moisture and flavor.

When using the preset speedcook recipes on the food menu, the power levels are already selected for you. However, these power levels can be adjusted before or during cooking by using the dial to select to edit the cook mode setting. The my recipes feature allows you to speedcook items not on the preset food menu by selecting your own cook time and power level settings.

Each power level gives you heater power and microwave energy for a certain percentage of the time.

*UPPER HEATER (UH)* controls both the upper halogen light and upper ceramic heater. A higher *UPPER HEATER* setting will utilize more upper heater power, browning food faster on top.

Select a higher setting for foods such as pizza and baked goods. Select a lower setting for foods such as casseroles, meat and fish.

*LOWER HEATER (LH)* controls the lower heater.

Select a higher setting to brown foods more on the bottom. Select a lower setting for less browning on the bottom.

Microwave (M) controls the microwave power. A higher setting will utilize more microwave power causing food to cook more evenly.

1. Press the SPEEDCOOK pad and turn the dial to select FOOD MENU or FAVORITE RECIPE, or press CUSTOM SPEEDCOOK to manually set power level and timer. Press the dial to enter.
2. Turn the dial to select a food, time or power level as prompted. Press the dial to enter.
3. To change the power level when prompted by the display, turn the dial clockwise to increase or counterclockwise to decrease the upper power level. Press the dial to enter.
4. Microwave levels are set automatically based on the upper and lower lamp settings.
5. Press the START/PAUSE pad or the selector dial to start cooking.

*If you do not want to change one of the settings, just press the dial to move to the next selection.*

**NOTE:** *Be careful when adjusting power levels so that you do not over- or undercook food.*

*Follow these general guidelines when selecting the best UH, LH and M settings for your favorite recipe:*

UH = Select a higher setting for thin foods requiring a golden brown top (example: fish fillets, toast, boneless chicken breasts). Select a lower setting for thicker foods and foods with high sugar or fat content (example: cakes, roasts).

M = Select a higher setting to cook food more evenly.

LH = Select a higher setting for thick or dense foods that may not cook quickly in the center (example: casseroles). Select a lower setting for thin foods (example: cookies) and foods containing high fat or sugar content (example: pastry, cakes).

### Speedcook cookware

- Follow cookware suggestions on the oven display or in the cookbook or cooking guide.
- Cookware will become hot because of heat transferred from the heated food. Oven mitts will be needed to handle the cookware.
- Place food directly on the nonstick metal tray when cooking, unless prompted by the oven to do otherwise.
- Use the nonstick metal tray in the same way you would use a shallow baking pan or baking tray.
- In addition to the cookware provided, you can use non-metal casserole dishes, pie plates and other heat-safe cookware. Place them directly on the turntable.

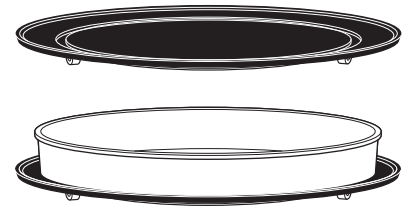

- Be sure to select a size that will rotate easily.
- Place the nonstick metal tray on the turntable. Place glass or ceramic cookware on the tray.
- Do not use cookware or coverings made of paper, plastic or foil when cooking during a speedcook cycle.

### My recipes

Upper oven gives you the flexibility to cook your favorite dishes.

If you want to cook a food item that is not among the preset selections, use my recipes.

1. Press the SPEEDCOOK pad.

*If no entries are made within 15 seconds, the display will revert back to the time of day.*

2. Turn the selector dial to select my recipes. Press the dial to enter.
3. Press dial to select new recipe.
4. Turn to select cooking time.

*The display will prompt you to select the power level(s).*

5. Turn the dial clockwise to increase or counterclockwise to decrease the upper heater power level. Press the dial to enter.
6. Turn the dial to change the lower heater power level. Press the dial to enter.

7. Turn the dial to change the microwave power level press the dial to enter.

8. Press the START/PAUSE pad or press the selector dial to start cooking. Select edit to edit selections.

*For power level and cooking time suggestions, use your cooking guide or cookbook.*

*You can select save to save my recipe you just programmed for later use. SPELL THE FOOD NAME appears. Turn the dial to the first letter of your food description and press the dial to enter. Continue this process to spell the rest of the food name. Press the START/PAUSE pad to save the recipe and its name. To access the saved recipe, press speedcook, my recipes and select the recipe you saved.*



### *My recipes*

#### **To edit/delete stored custom speedcook recipes:**

1. Press the *SPEEDCOOK* pad.
2. Turn dial to my recipes. Press the dial to enter.
3. Turn dial to select the stored custom recipe. Press the dial to enter.
4. Turn dial to edit or delete to edit or delete the custom recipe. Press the dial to edit or delete.

# Baking, Broiling and Toasting

## Upper Oven

### Baking, Broiling and Toasting

Baking allows you to cook foods the same way as a conventional oven, using a heating element to raise the temperature of the air inside the oven. Any oven temperature from 250°F to 450°F may be set.

Broiling allows you to broil foods in the same way as a conventional oven.

Toasting allows you to toast foods the same way as a conventional oven.

A fan gently circulates heated air throughout the oven, over and around the food. Because the heated air is kept constantly moving, not permitting a layer of cooler air to develop around the food, some foods cook slightly faster than in regular oven cooking.

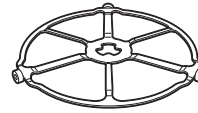

The **turntable** must always be in place when using the oven.



Put food or oven-safe cookware directly on the **metal tray** to bake.

Before you begin, make sure the turntable is in place. Use the metal tray at all times when baking.

**CAUTION:** When baking, remember that the oven, door and dishes will be very hot!

### How to Bake

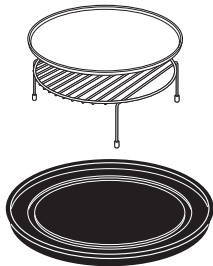

For two-level baking, place food in a metal baking dish or directly on the non-stick metal tray. Place the aluminum baking sheet or your baking dish with food on top of the wire rack. Stand the rack with food on the metal tray.

1. Press the CONV BAKE pad.
2. Turn the dial to set the oven temperature and press to enter.
3. Select START or COOK TIME.

#### Preheat after selecting start:

1. The oven starts preheating immediately. Do not place the food in the oven.
2. When the oven is finished preheating, it will signal. If you do not open the door within 1 hour, the oven will turn off automatically. Open the oven door and, using caution, place the food in the oven.
3. Close the oven door. Press the dial twice to set the cook time and press START/PAUSE to start cooking. When cooking is complete, the oven will signal and turn off.

*You may change the oven temperature during preheating by pressing the dial and turning the dial to select the new temperature.*

*If the oven door is opened during cooking, PAUSE will appear in the display. Close the door and press START/PAUSE.*

*Cook times are shown in minutes and can be a maximum of 179 minutes. Time can be changed during cooking by turning the dial.*

#### Preheat after selecting cook time:

1. After select a cook time, oven will prompt you to start cook time or start preheat.
2. Press start cook time to skip preheat or press start preheat to preheat.
3. When the oven is finished preheating, it will signal. If you do not open the door within 1 hour, the oven will turn off automatically. Open the oven door and, using caution, place the food in the oven.
4. Close the oven door. Press dial to edit temperature or cook time, if needed and/or press START/PAUSE to start cooking. When cooking is complete the oven will signal and turn off.

### How to Broil or Toast



Put food directly on the aluminum baking sheet on the wire oven rack, and place them on the metal tray, when broiling or toasting foods.

1. Press the COOKING OPTIONS pad.
2. Turn the dial to BROIL or TOAST and press to enter.
3. If Broil, press the dial to start.
4. If Toast, turn dial to select time and press to select. Press dial again to start.

*If the oven door is opened during cooking, PAUSE will appear in the display. Close the door and press START/PAUSE.*

### Warming

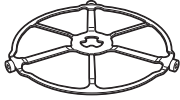

The **turntable** must always be in place when using the oven.



Put food directly on the **non-stick metal tray** to warm.

#### Tips for Crisp Foods:

- Leave food uncovered.
- Do not use plastic containers or plastic wrap.

#### Tips for Moist Foods:

- Cover food with lid or aluminum foil.
- Do not use plastic containers or plastic wrap.

The **WARM** feature will keep hot, cooked foods at serving temperature. Always start with hot food. Use cookware and utensils that can withstand temperatures up to 230°F.

1. Press the COOKING OPTIONS pad.
2. Turn the dial to WARM. Press the dial to enter.
3. Turn the dial to select Moist/Crisp. Press the dial to enter.

If the oven door is opened during warming, **PAUSE** will appear in the display. Close the door and press **START/PAUSE**.

#### To Crisp Stale Items:

- Place food or dishes directly on the black metal tray.
- Check crispness periodically. Add time as needed.

### Temperature and Moisture Selection Chart

Food Type	Moisture Setting
Bread, hard rolls	CRISP
Bread, soft rolls	MOIST
Casseroles	MOIST
Fried foods	CRISP
Meats* and fish	CRISP
Pancakes, waffles	CRISP
Pizza	CRISP
Potatoes, baked	CRISP
Potatoes, mashed	MOIST
Poultry	MOIST
Tortilla Chips	CRISP
Vegetables	MOIST

\* USDA/FSIS recommends an internal temperature of 145°F as the minimum doneness for beef. Use a portable meat thermometer to check internal temperatures.

### Proofing

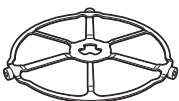

The **turntable** must always be in place when using the oven.



Put bread dough in a bowl/bread pan and place on the **metal tray** to proof.

The proofing feature automatically provides the optimum temperature for the proofing process, and therefore does not have a temperature adjustment.

1. Press the COOKING OPTIONS pad.
2. Turn the dial to select PROOF. Press the dial to enter. The oven starts proofing immediately and shows the amount of proofing time completed.

- To optimize performance avoid unnecessary door opening.
- Check bread products early to avoid over-proofing.

#### NOTES:

- Do not use the proofing mode for warming food or keeping food hot. The proofing oven temperature is not hot enough to hold foods at safe temperatures. Use the WARM feature to keep food warm.
- Proofing will not operate if the oven is too hot. Allow the oven to cool before proofing.

## Using the microwave features

Make sure the turntable and clear glass tray are in place.  
Place food or microwavable container directly on the clear glass tray to cook your food.

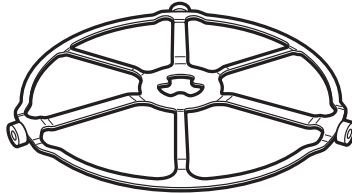

The **turntable** must always be in place when using the oven.

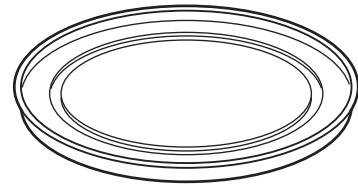

The **clear glass tray** should always be in place when **microwaving**.

## Cookware

- Make sure that cookware is suitable for microwaving.
- Place food or microwavable container directly on the clear glass tray to cook your food.

### MICROWAVE PRESET SELECTIONS:

#### ■ Beverage

- Water (8-12 oz.)
- Coffee (8-12 oz.)
- Tea (8-12 oz.)
- Milk (8-12 oz.)
- Hot Cocoa (8-12 oz.)

#### ■ Popcorn

- Popcorn Sensor

#### ■ Melt

- Butter
- Caramel
- Cheese
- Chocolate Chips
- Marshmallow

#### ■ Simmer

#### ■ Cook

- By Food Type
- By Time
- By Time 1 & 2

#### ■ Soften

- Butter
- Cream Cheese
- Frosting (16 oz.)
- Ice Cream

#### ■ Defrost

- 1.0 lb Quick
- By Time
- By Weight
- By Food Type
- Melt
- Soften

#### ■ Reheat

- Beverage
- Casserole
- Chicken
- Pasta
- Pizza
- Plate of Food
- Rice
- Soup
- Steaks/Chops
- Vegetables

## How to use pre-set microwave selections

1. Press the MICROWAVE pad.

*If no selection is made within 15 seconds, the display will revert back to the time of day.*

2. Turn the dial to find the food you want to cook, defrost or reheat. Press the dial to enter.
3. Turn the selector dial to select the type, amount, weight and/or size. (As required, the oven will prompt you.) Press the dial after each selection.

4. Press the dial or the START/PAUSE pad to start cooking.

*To review or edit settings during cooking, press the selector dial.*

*If the door is opened during cooking, the oven will stop and PAUSE will appear in the display. Close the door and press START/PAUSE to resume cooking.*

*If you enter an undesired selection at any time, simply press the BACK pad and reenter the desired selections.*

## Cook By Time and Cook By Time 1 & 2

Use **COOK BY TIME** and **COOK BY TIME 1 & 2** to microwave food that is not in the recipe section and at the time(s) you set.

■ The power level is automatically set at high, but you can change it for more flexibility.

1. Press the MICROWAVE pad.
2. Turn the dial to select **COOK BY TIME** or **COOK BY TIME 1 & 2** and press the dial to enter.
3. Turn the dial to set the cook time and press the dial to enter.

4. Select power level setting.

If you selected **COOK BY TIME 1 & 2**, turn the dial to set the second cook time, second power level setting and press the dial to enter.

5. Press the dial or the START/PAUSE pad to start cooking.

You may open the door during **COOK BY TIME** and **COOK BY TIME 1 & 2** to check the food. Close the door and press **START/PAUSE** to resume cooking.

---

## Add 30 Sec

Press **ADD 30 SEC** repeatedly for 30-second increments of microwave cooking time. Oven starts immediately.

Use this feature to instantaneously start microwave. Also use this button to add 30 seconds to cooking.

---

## Microwave power level(s)

■ You can change the power level during most cooking program.

1. Press the dial to edit
2. Rotate dial to change time and/or press dial to enter.
3. Turn the dial clockwise to increase and counterclockwise to decrease the power level. Press the dial to enter.

Here are some examples of uses for various power levels:

**High 10:** Fish, bacon, vegetables, boiling liquids.

**Med-High 7:** Gentle cooking of meat and poultry; baking casseroles and reheating.

**Medium 5:** Slow cooking and tenderizing for stews and less tender cuts of meat.

**Low 2 or 3:** Defrosting, simmering, delicate sauces.

**Warm 1:** Keeping food warm, softening butter.

---

## Cooking tips

■ When cooking bacon, layer strips on a plate. Cover each layer with a paper towel.

■ When cooking vegetables, use a microwave-safe casserole or bowl. Cover with a microwave-safe lid or vented plastic wrap.

■ For frozen vegetables, follow the package instructions for adding water.

■ For fresh vegetables, add 2 tablespoons of water for each serving.

## Defrost by food type

Auto Defrost automatically sets the defrosting times and power levels to give even defrosting results for meats, poultry and fish weighing up to 6 pounds.

1. Remove food from the package and place it on a microwave-safe dish.
2. Press the MICROWAVE pad and select defrost.
3. Turn the dial to *DEFROST BY FOOD TYPE*. Press the dial to enter.
4. Turn the dial to select food type. Press the dial to enter.
5. Turn the dial to the food weight, using the Conversion Guide at the right. For example, dial 1.2 for 1.2 pounds (1 pound, 3 oz.) Press the dial to enter.
6. Press the dial or START/PAUSE pad to start defrosting.
7. Turn the food over when the oven signals *TURN FOOD OVER*.

- Remove defrosted meat or shield warm areas with small pieces of foil for even defrosting.
- After defrosting, most meats need to stand 5 minutes to complete defrosting. Large roasts should stand for about 30 minutes.

### Conversion Guide

If the weight of food is stated in pounds and ounces, the ounces must be converted to tenths (.1) of a pound.

Weight of Food in Ounces	Enter Food Weight (tenths of a pound)
1-2	.1
3	.2
4-5	.3
6-7	.4
8	.5
9-10	.6
11	.7
12-13	.8
14-15	.9

## Defrost by time

Use *DEFROST BY TIME* to defrost for a selected length of time.

1. Press the MICROWAVE pad and select defrost.
2. Turn the selector dial to *DEFROST BY TIME*. Press the dial to enter.
3. Turn the dial to select the time you want. Press the dial to enter.
4. Press the dial or START/PAUSE pad to start defrosting.
5. Turn the food over when the oven signals *TURN FOOD OVER*.

Power level is automatically set at 3, but can be changed. To change the power levels, see the *Microwave Power Level(s)* section. You can defrost small items quickly by raising the power level after entering the time. Power level 7 cuts the total defrosting time in about half; power level 10 cuts the total time to about 1/3. When defrosting at high power levels, food will need more frequent attention than usual.



## Microwaving

Upper Oven

### *Defrost by weight*

Use *DEFROST BY WEIGHT* to defrost for a selected length of time.

1. Press the MICROWAVE pad and select defrost.
2. Turn the selector dial to *DEFROST BY WEIGHT*. Press the dial to enter.
3. Turn the dial to select the weight you want. Press the dial to enter.

4. Press the dial or START/PAUSE pad to start defrosting.

5. Turn the food over when the oven signals *TURN FOOD OVER*.

*Power level cannot be changed during this setting.*

### *1.0 lb. Quick Defrost*

Use *1.0 lb. QUICK DEFROST* for quick defrost of 1.0 lb. of frozen food.

1. Press the MICROWAVE pad and select 1.0 Lb. quick defrost.
2. Press dial or START/PAUSE pad to start defrosting. Press the dial to enter.

3. Turn the food over when the oven signals *TURN FOOD OVER*.

*Power level cannot be changed during this setting.*

### *Defrosting tips*

- Foods frozen in paper or plastic can be time defrosted in the package, but foods should be taken out of the package when using *DEFROST BY FOOD TYPE*. Closed packages should be slit, pierced or vented **after** food has partially defrosted. Plastic storage containers should be partially uncovered.
- Family-size, prepackaged frozen dinners can be defrosted and microwaved. If the food is in a foil container, transfer it to a microwave-safe dish.
- Foods that spoil easily should not be allowed to sit out for more than one hour after defrosting. Room temperature promotes the growth of harmful bacteria.
- For more even defrosting of larger foods, such as roasts, use *DEFROST BY TIME*. Be sure large meats are completely defrosted before cooking.
- When defrosted, food should be cool but softened in all areas. If still slightly icy, return to the microwave very briefly, or let it stand a few minutes.

Microwaving

Upper Oven

---

*Reheat*

---

*Melt*

---

*Soften*

---

*Simmer*

---

*Beverage*

---

*Popcorn*

*Microwave sensor cooking*

*The sensor feature detects the increasing humidity released during cooking. The oven automatically adjusts the cooking time to various types and amounts of food.*

*Do not use the Sensor Features twice in succession on the same food portion—it may result in severely overcooked or burnt food. If food is undercooked after the first countdown, use **COOK BY TIME** for additional cooking time.*

*The proper containers and covers are essential for best sensor cooking.*

- Always use microwave-safe containers and cover them with lids or vented plastic wrap. Never use tight sealing plastic containers—they can prevent steam from escaping and cause food to overcook.
- Be sure the outside of the cooking containers and the inside of the oven are dry before placing food in the oven. Beads of moisture turning into steam can mislead the sensor.
- Beverages are best heated uncovered.

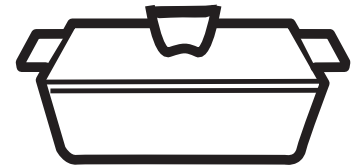

Covered



Vented

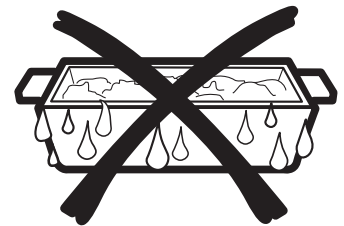

Dry off dishes so they don't mislead the sensor.

**MICROWAVE SENSOR PROGRAMS:**

- *Ground Meat*
- *Popcorn*
- *Soup*
- *Rice*
- *Vegetables (Canned, Fresh, Frozen)*
- *Chicken Reheat*
- *Pasta Reheat*
- *Plate of Food Reheat*
- *Soup Reheat*
- *Vegetable Reheat*

### *To use all sensor programs*

*Upper Oven microwave mode features sensor cooking. It automatically senses when food is done and shuts itself off—eliminating the need to program cook times and power levels.*

1. Press the MICROWAVE pad and turn the dial to COOK BY FOOD TYPE or REHEAT. Press the dial to enter. Or press the REHEAT pad.
2. Turn the dial to select the food you want. Press the dial to enter.
3. Press the dial or press the START/PAUSE pad to start cooking.

Do not open the oven door until time is counting down in the display or the microwave stop cooking. If the door is opened, close it and press START/PAUSE immediately. If the food is not done enough, use *COOK BY TIME* in the microwave selector to cook for more time.

**NOTE:** Do not use the Sensor Features twice in succession on the same food portion—it may result in severely overcooked or burnt food.

- If you have been speedcooking and the oven is already hot, it may indicate that it is too hot for sensor cooking. Of course, you can always continue with *COOK BY TIME*.

**NOTE:** *If the oven is too hot then it will automatically change to time cooking.*

- To shorten or lengthen the cook time, wait until the time countdown shows in the display. Then turn the dial to add or subtract time.
- If you open the door while *Sensor Cooking*, *SENSOR ERROR* will appear. Close the door, press START/PAUSE to begin again.

### ***Notes about the Reheat program:***

Reheated foods may have wide variations in temperature. Some areas may be extremely hot.

It is best to use *COOK BY TIME* and not *REHEAT* for these foods:

- Bread products
- Food that must be reheated uncovered.
- Foods that need to be stirred or turned.
- Foods calling for a dry look or crisp surface after reheating.

*Cooking Complete Reminder*

To remind you that you have food in the oven, the oven will display *COOK TIME COMPLETED* and beep once a minute until you either open the oven door or press the CANCEL/OFF pad.

*Features under the SETTINGS pad*

***Clock:***

*The clock must be set before you can use your oven for the first time (see Quick Start for instructions).*

1. To change the clock time, press the SETTINGS pad and turn the dial to *CLOCK*. Press the dial to enter.
2. Turn the dial to set hours. Press the dial to enter.
3. Turn the dial to set minutes. Press the dial to enter.
4. Turn the dial to select AM or PM. Press the dial to enter.

***Display Mode:***

Use this feature to set your display to power saver mode or always on. Press the OPTIONS pad, turn the dial to select *CLOCK DISPLAY ON/OFF*. Turn the dial to select *ON* or *OFF*. Press the dial to enter.

***Beeper Volume:***

Use this feature to turn beeper volume on. Press the SETTINGS pad, turn the dial to select *BEEPER VOLUME*, press the dial to enter some beeper tone are not mutable.

***Reminder:***

Use this feature to set an alarm beep to sound at a specific time of day. Press the OPTIONS pad, turn the dial to *SET/CLEAR REMINDER* and press the dial to enter. Turn the dial to select the hour and press to enter. Turn the dial to select the minute and press to enter. Turn the dial to select AM or PM and press to enter.

To review the setting, turn the dial to *SET/CLEAR REMINDER* and press the dial to enter. Turn the dial to *REVIEW* and press to enter.

To cancel the setting, turn the dial to *SET/CLEAR REMINDER* and press the dial to enter. Turn the dial to *CLEAR* and press to enter.

Settings  
"Help"

**NOTE:** Not all features of help would be on your oven model

*Use this feature to find out more about your oven and its features.*

1. Press the SETTINGS pad and select help.

2. Turn the dial to select the feature name. Press the dial to enter.

The display will show a description for the program you have chosen.

*Features found in the HELP function.*

<i>Adding Time</i>	<i>Defrost by Weight</i>	<i>Start/Pause</i>
<i>Auto Conversion</i>	<i>Delay Start</i>	<i>Steam Clean</i>
<i>Auto Shut-Off</i>	<i>Display Mode</i>	<i>Temperature Units</i>
<i>Back</i>	<i>Edit</i>	<i>Thermostat Adjust</i>
<i>Bake</i>	<i>Help</i>	<i>Timer On/Off</i>
<i>Beeper Volume</i>	<i>Melt</i>	<i>Toast</i>
<i>Beverage</i>	<i>Micro 30 Secs</i>	<i>Warm</i>
<i>Broil</i>	<i>Microwave</i>	
<i>Clear/Off</i>	<i>My recipes</i>	
<i>Clock</i>	<i>Probe</i>	
<i>Control Lockout</i>	<i>Proof</i>	
<i>Cook</i>	<i>Reheat</i>	
<i>Cook by Food</i>	<i>Reminder</i>	
<i>Cook by Time</i>	<i>Repeat Last</i>	
<i>Cook by Time 1 &amp; 2</i>	<i>Resume</i>	
<i>Cooking Options (Lower)</i>	<i>Sabbath</i>	
<i>Cooking Options (Upper)</i>	<i>Self Clean</i>	
<i>Defrost</i>	<i>Sensor Cooking</i>	
<i>Defrost by Food</i>	<i>Simmer</i>	
<i>Defrost by Time</i>	<i>Soften</i>	
	<i>Speed Cook</i>	



### *Things that are normal*

#### **Cooking Times**

- When speedcooking preprogrammed foods, you may see *OPTIMIZING COOK TIME* in the display several seconds after you press START/PAUSE. The oven automatically senses the electrical voltage level in your home and adjusts the cooking time up or down for proper cooking.

#### **Fan/Vent**

- The fan will be on during cooking. At the end of cooking, the automatic fan may continue to run for a short time, and the display will read *Oven is Cooling*. The fan will automatically shut off when the internal parts of the oven have cooled.
- The oven vent will emit warm air while the oven is on.

#### **Lights**

- When the oven is on, light may be visible around the door or outer case.
- The halogen lights will dim and cycle on and off during a speedcook cycle, sometimes even at full power levels. This is normal. The oven senses the heat level and adjusts automatically.

#### **Oven Heat**

- No preheating time is required during Speedcook cycles. The oven begins cooking immediately.
- The door and inside of the oven will be very hot. Use caution when opening the door and removing food.
- Do not use cookware or coverings made of paper, plastic or foil when cooking during a speedcook cycle.
- When cooking for an extended period of time, the oven may automatically reduce the power levels to maintain the appropriate level of oven heat.

#### **Sounds**

- Clicks and a fan blowing are normal sounds during cooking. The relay board is turning components on and off.

### *Things that are normal*

#### **Interference**

- TV/radio interference might be noticed while using the microwave. Similar to the interference caused by other small appliances, it does not indicate a problem with the microwave. Move the radio or TV as far away from the microwave as possible, or check the position of the TV/radio antenna.

#### **Lights**

- The oven cavity light will come on during a microwave cooking cycle.

#### **Oven Heat**

- Cookware may become hot because of heat transferred from the heated food. Oven mitts may be needed to handle the cookware.
- Steam or vapor may escape from around the door.

# Cooking Modes

Your new oven has a variety of cooking modes to help you get the best results. These modes are described below. Refer to the Cooking Guide section for recommendations for specific foods. Remember, your new oven may perform differently than the oven it is replacing.

## Baking and Roasting Modes

Select a mode for baking and roasting based on the type and quantity of food you are preparing. When preparing baked goods such as cakes, cookies, and pastries always preheat the oven first. Follow recipe recommendations for food placement. If no guidelines are provided, center food in the oven.

### Traditional Bake

The traditional bake mode is intended for single rack cooking. This mode uses heat primarily from the lower element but also from the upper element to cook food. To use this mode, press the **Bake** pad, enter a temperature, and then press **Start**. Preheating is generally recommended when using this mode.

### Convection Bake 1 Rack

The Convection Bake 1 Rack mode is intended for single rack cooking. This mode uses heat from the lower element and also the upper and rear elements, along with air movement from the convection fan to enhance evenness. Your oven is equipped with Auto Recipe Conversion, so it is not necessary to convert the temperature when using this mode. To use this mode press the **Convection Bake (1 Rack/Multi)** pad, enter a temperature, and then press **Start**. Preheating is generally recommended when using this mode.

### Convection Bake Multi Rack

The Convection Bake Multi Rack mode is intended for baking on multiple racks at the same time. This mode uses heat primarily from the rear element but also heat from the upper and lower elements, along with air movement from the convection fan to enhance cooking evenness. Your oven is equipped with Auto Recipe Conversion, so it is not necessary to convert the temperature when using this mode. Baking time might be slightly longer for multiple racks than what would be expected for a single rack. To use this mode press the **Convection Bake (1 Rack/Multi) Multi Rack** pad **twice**, enter a temperature, and then press **Start**. Always preheat when using this mode.

### Convection Roast

The Convection Roast mode is intended for roasting whole cuts of meat on a single rack. This mode uses heat from the lower, upper, and rear elements along with air movement from the convection fan to improve browning and reduce cooking time. It is not necessary to convert temperature. Check food earlier than the recipe suggested time when using this mode, or use a meat probe. To use this mode press the **Convection Roast** pad, enter a temperature, and then press **Start**. It is not necessary to preheat when using this mode.

## Broiling Modes

Always broil with the door closed. The broil element in this oven is very powerful. Monitor food closely while broiling. Use caution when broiling on upper rack positions as placing food closer to the broil element increases smoking, spattering, and the possibility of fats igniting. **Broiling on rack position 6 is not recommended.**

Try broiling foods that you would normally grill. Adjust rack positions to adjust the intensity of the heat to the food. Place foods closer to the broil element when a seared surface and rare interior is desired. Thicker foods and foods that need to be cooked through should be broiled on a rack position farther from the broiler or by using Broil Lo. For best performance center food below the broil heating element.

### Broil Hi

The Traditional Broil Hi mode uses intense heat from the upper element to sear foods. Use Broil Hi for thinner cuts of meat and/ or foods you prefer less done on the interior. To use this mode press the **Broil** pad once and then press **Start**. It is not necessary to preheat when using this mode.

### Broil Lo

The Traditional Broil Lo mode uses less intense heat from the upper element to cook food thoroughly while also producing surface browning. Use Broil Lo for thicker cuts of meat and/or foods that you would like cooked all the way through. To use this mode press the **Broil** pad **twice** and then press **Start**. It is not necessary to preheat when using this mode.

## Proof

Proof mode is designed for rising (fermenting and proofing) bread doughs. Press the **Proof** pad and then press **Start**. Cover dough well to prevent drying out. Bread will rise more rapidly than at room temperature. Note that for double wall ovens, proof can not be run when running a clean mode in the lower oven.

## Warm

Warm mode is designed to keep hot foods hot for up to 3 hours. To use this mode, press the **Warm** pad then press **Start**. Cover foods that need to remain moist and do not cover foods that should be crisp. Preheating is not required not use warm to heat cold food other than crisping crackers, chips or dry cereal. It is also recommended that food not be kept warm for more than 2 hours.

# Cooking Guide

Lower Oven

FOOD TYPE	RECOMMENDED MODE(S)	RECOMMENDED RACK POSITION(S)	ADDITIONAL SUGGESTIONS
<b>Baked Goods</b>			
Layer cakes, sheet cakes, bundt cakes, muffins, quick breads on a Single Rack	Traditional Bake	3	Use shiny cookware.
Layer cakes* on Multiple Racks	Traditional Bake	2 and 4	Extension rack in higher position if used. Ensure adequate airflow (see illustration below).
Chiffon cakes (angel food)	Traditional Bake	1	Use shiny cookware.
Cookies, biscuits, scones on a Single Rack	Traditional Bake	3	Use shiny cookware.
Cookies, biscuits, scones on Multiple Racks	Convection Bake Multi	2 and 4 1, 3 and 5	Extension rack position 4 for 2 racks, 1 for 3 racks. Ensure adequate airflow.
<b>Beef &amp; Pork</b>			
Hamburgers	Broil Hi	5	Use the extension rack and use a broil pan; move food down for more doneness/less searing. Watch food closely when broiling. For best performance center food below the broil heating element.
Steaks & Chops	Broil H	5	Use a broil pan; Move food down for more doneness/less searing. Watch food closely when broiling. For best performance center food below the broil heating element.
Roasts	Convection Roast	2 or 3	Use a low sided pan such as a broil pan. Preheating is not necessary.
<b>Poultry</b>			
Whole chicken	Convection Roast	2 or 3	Use a low sided pan such as a broil pan.
Bone-in chicken breasts, legs, thighs	Broil Hi	1	If breaded or coated in sauce avoid Broil Hi modes. Broil skin side down first. Watch food closely when broiling. For best performance when broiling, center food below the broil heating element.
	Broil Lo Traditional Bake Convection Bake 1 Rack	3	
Boneless chicken breasts	Broil Lo Traditional Bake Convection Bake 1 Rack	3	Move food down for more doneness/less searing and up for greater searing/browning when broiling. For best performance when broiling, center food below the broil heating element.
Whole turkey	Convection Roast	1 or 2	Use a low sided pan such as a broil pan.
Turkey Breast	Convection Roast	2 or 3	Use a low sided pan such as a broil pan.
<b>Fish</b>	Broil Lo	5 (1/2 thick or less) 4 (>1/2 inch)	Watch food closely when broiling. For best performance center food below the broil heating element.
<b>Casseroles</b>	Convection Bake 1 Rack Traditional Bake	3	
<b>Frozen Convenience Foods</b>			
Pizza, french fries, tator tots, chicken nuggets, appetizers on a Single Rack	Convection Bake 1 Rack Traditional Bake	3	Use shiny cookware.
Pizza, french fries, tator tots, chicken nuggets, appetizers on Multiple Racks	Convection Bake Multi	2 and 4	Use shiny cookware.

\*When baking four cake layers at a time, use racks 2 and 4. Place the pans as shown so that one pan is not directly above another.

Cook food thoroughly to help protect against food borne illness. Minimum safe food temperature recommendations for food safety can be found at [www.IsItDoneYet.gov](http://www.IsItDoneYet.gov). Make sure to use a food thermometer to take food temperatures.

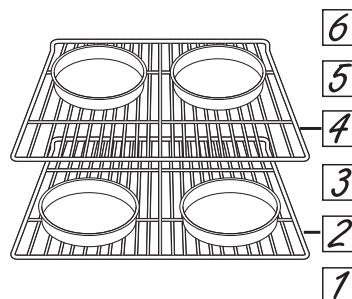

# Oven Racks

Lower Oven

Your oven has six rack positions. Recommended rack positions for various types of foods are provided in the Cooking Guide. Adjusting rack position is one way to impact cooking results. For example, if you would prefer darker tops on cakes, muffins, or cookies, try moving food one rack position higher. If you find foods are too brown on top try moving them down next time.

When baking with multiple pans and on multiple racks, ensure there is at least 1½" between pans to allow sufficient space for air to flow.

## Oven Racks

Your oven may have extension racks and/or traditional flat racks.

To avoid possible burns, place the racks in the desired position before you turn the oven on.

## Extension Racks

Extension racks have an install feature that locks into the rack supports (guides) on both sides. Once the install feature is locked into place, always pull the rack out, by its upper front rail, to its full extension stop position, when placing or removing cookware.

If extension racks are difficult to extend, lubricate the racks with the graphite lubricant provided with your oven. Remove the rack from the oven, remove debris in the slide tracks with a paper towel, shake the graphite lubricant and place 4 small drops on the two bottom tracks of the left and right sides. Open and close the rack several times to distribute the lubricant.

To order additional graphite lubricant, read the Assistance and Accessories section at the beginning of this manual.

### To Remove An Extension Rack:

1. Make sure the rack is pushed all the way into the oven.
2. Grasp the rack by both its upper front rail and its lower handles on two sides and lift straight up to unlock the rack from the rack supports.
3. Firmly holding onto both the upper front rail and lower handles on both sides, pull the rack forward. Grasp the rack on both sides if necessary. Then remove it from the oven.

### To Replace An Extension Rack:

1. Place the rear portion of the rack onto the rack supports (guides) as shown in the picture.
2. Hold the upper front rail and lower handles and push the rack all the way in until the install feature locks into the front rack support.

If extension racks are difficult to replace or remove, wipe the oven rack supports with cooking oil. Do not wipe oil on the rack slides.

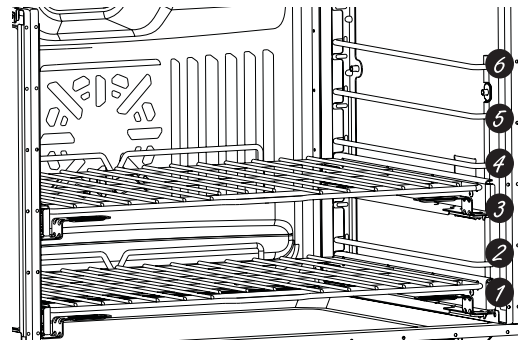

The oven has 6 rack positions

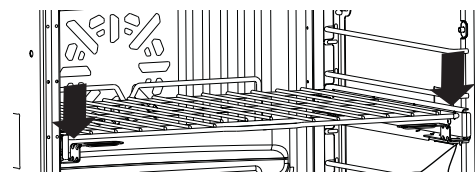
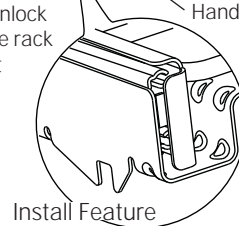
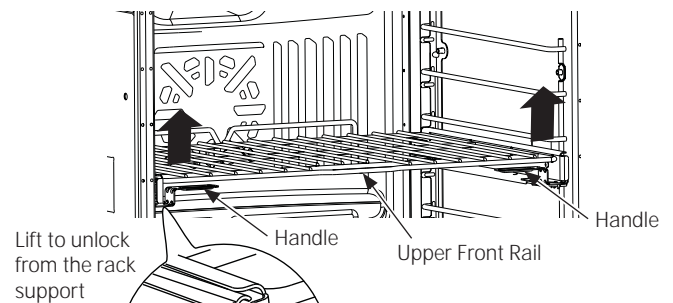
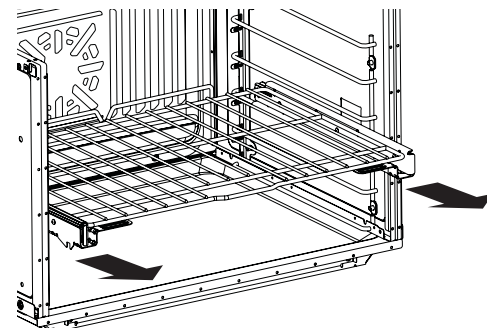
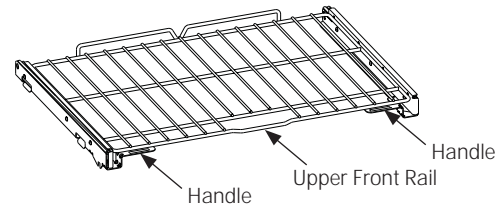

Hold the upper front rail and lower handles and push the rack all the way in until the install feature locks on the front support

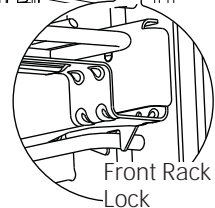

## Oven Racks (cont.)

Lower Oven

### Traditional Flat Racks

The racks have stops so that when placed correctly on the supports they will stop before coming completely out and will not tilt. When placing and removing cookware, pull the rack out until it stops.

#### To Remove a Rack

Pull it toward you, tilt the front end up and pull it out.

#### To Replace a Rack

Tilt the front of the rack up, hook the rear locating posts under the rack supports, push the rack back (past the stop-locks) and lower it into position. Push the rack all the way in.

If flat racks are difficult to slide and/or remove, place some cooking oil on a soft cloth or paper towel and rub onto the sides of the rack and each rack support.

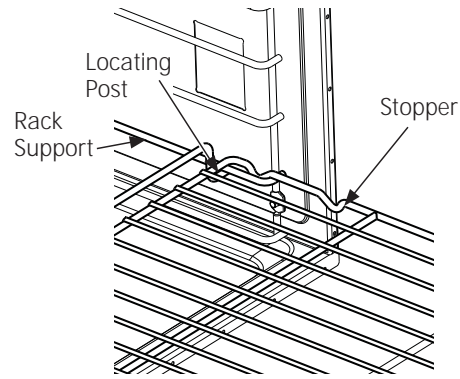
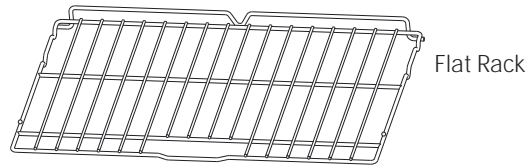

**⚠ CAUTION:** Use caution when removing a rack from lowest position as door may be hot.

## Aluminum Foil and Oven Liners

**⚠ CAUTION:** Do not use any type of foil or oven liner to cover the oven bottom. These items can trap heat or melt, resulting in damage to the product and risk of shock, smoke or fire. Damage from improper use of these items is not covered by the product warranty.

Foil may be used to catch spills by placing a sheet on a lower rack, several inches below the food. Do not use more foil than necessary and never entirely cover an oven rack with aluminum foil. Keep foil at least 1-1/2" from oven walls to prevent poor heat circulation.

## Cookware

### Cookware Guidelines

The material, finish, and size of cookware affect baking performance.

Dark, coated and dull pans absorb heat more readily than light, shiny pans. Pans that absorb heat more readily can result in a browner, crisper, and thicker crust. If using dark and coated cookware check food earlier than minimum cook time. If undesirable results are obtained with this type of cookware consider reducing oven temperature by 25° F next time.

Shiny pans can produce more evenly cooked baked goods such as cakes and cookies.

Glass and ceramic pans heat slowly but retain heat well. These types of pans work well for dishes such as pies and custards.

Air insulated pans heat slowly and can reduce bottom browning.

Keep cookware clean to promote even heating.



#### *Helpful hints*

An occasional thorough wiping with a solution of baking soda and water keeps the inside fresh.

**Be certain the oven control is turned off before cleaning any part of this oven.**



#### *How to clean the inside*

Clean the inside of the oven often for proper heating performance.

Some spatters can be removed with a paper towel, others may require a warm soapy cloth. Remove greasy spatters with a sudsy cloth; then rinse with a damp cloth.

Do not use abrasive cleaners or sharp utensils on oven walls.

**Never use a commercial oven cleaner on any part of your oven.**

Do not clean the inside of the oven with metal scouring pads. Pieces can break off the pad, causing electrical shock.

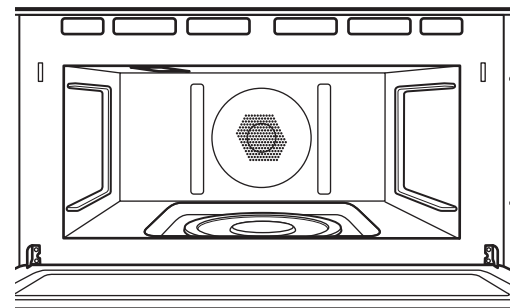

Walls, Floor, Inside Window, Metal and Plastic Parts on the Door

#### *Removable turntable*

The area underneath the turntable should be cleaned frequently to avoid odors and smoking during a cooking cycle.

The turntable can be broken if dropped. Wash carefully in warm, sudsy water. Dry completely and replace.

To replace the turntable, place its center over the spindle in the center of the oven and turn it until it seats into place. (Make sure the smooth side of the turntable is facing up and that its center seats securely on the spindle.)

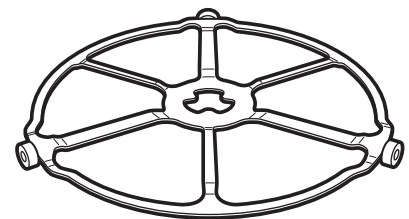

Turntable

Do not use the oven without the turntable in place.



## Care and Cleaning

### Upper Oven

---

#### *Cooking trays and baking sheet*

To prevent breakage, allow the trays to cool completely before cleaning. Wash carefully in warm, sudsy water or in the dishwasher.

Do not use metal scouring pads or abrasives, as they may damage the finish. A soap-filled scouring pad may be used to clean the trays.

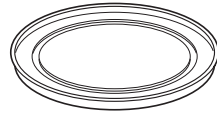

Clear glass tray for microwaving



Non-stick metal tray for speedcooking

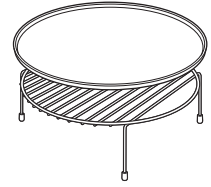

Put food directly on the aluminum baking sheet on the wire oven rack, and place them on the non-stick metal tray, when baking on two levels, broiling or toasting foods.

#### *How to clean the outside*

***We recommend against using cleaners with ammonia or alcohol, as they can damage the appearance of the oven. If you choose to use a common household cleaner, first apply the cleaner directly to a clean cloth, then wipe the soiled area.***

##### ***Case***

Clean the outside with a sudsy cloth. Rinse and then dry. Wipe the window clean with a damp cloth.

##### ***Glass Control Panel and Door***

Wipe with a clean damp sponge. Dry thoroughly. Do not use cleaning sprays, large amounts of soap and water, abrasives or sharp objects on the panel—they can damage it.

##### ***Door Seal***

It's important to keep the area clean where the door seals against the oven. Use only mild, nonabrasive detergents applied with a clean sponge or soft cloth. Rinse well.

#### *Stainless steel (on some models)*

To clean the stainless steel surface, use warm, sudsy water or a stainless steel cleaner or polish. Always wipe the surface in the direction of the grain. Follow the cleaner instructions for cleaning the stainless steel surface.

To inquire about purchasing stainless steel appliance cleaner or polish, or to find the location of a dealer nearest you, please call our toll-free number, 800.626.2002 or visit [GEAppliances.com](http://GEAppliances.com).

# Care and Cleaning

Lower Oven

Be sure electrical power is off and all surfaces are cool before cleaning any part of the oven.

## Control Panel

It's a good idea to wipe the control panel after each use. Clean with mild soap and water or vinegar and water, rinse with clean water and polish dry with a soft cloth.

Do not use abrasive cleansers, strong liquid cleansers, plastic scouring pads or oven cleaners on the control panel—they will damage the finish.

## Oven Exterior

Do not use oven cleaners, abrasive cleansers, strong liquid cleansers, steel wool, plastic scouring pads, or cleaning powders on the interior or exterior of the oven. Clean with a mild soap and water or vinegar and water solution. Rinse with clean water and dry with a soft cloth. When cleaning surfaces, make sure that they are at room temperature and not in direct sunlight.

If stain on the door vent trim is persistent, use a mild abrasive cleaner and a sponge-scrubber for best results.

Spillage of marinades, fruit juices, tomato sauces and basting liquids containing acids may cause discoloration and should be wiped up immediately. Let hot surfaces cool, then clean and rinse.

## Stainless Steel Surfaces (on some models)

Do not use a steel wool pad; it will scratch the surface.

To clean the stainless steel surface, use warm sudsy water or a stainless steel cleaner or polish. Always wipe the surface in the direction of the grain. Follow the cleaner instructions for cleaning the stainless steel surface.

To inquire about purchasing cleaning products including stainless steel appliance cleaner or polish, read the Assistance and Accessories section at the beginning of this manual.

## Oven Interior

The interior of your new oven can be cleaned manually or by using the Steam Clean or Self Clean modes.

Spillage of marinades, fruit juices, tomato sauces and basting liquids containing acids may cause discoloration and should be wiped up immediately. Let hot surfaces cool, then clean and rinse.

### Manual Cleaning

Do not use oven cleaners, abrasive cleaners, strong liquid cleansers, steel wool, scouring pads, or cleaning powders on the interior of the oven. Clean with a mild soap and water or vinegar and water solution. Rinse with clean water and dry with a soft cloth. When cleaning surfaces, make sure that they are at room temperature.

### Steam Clean Mode

Steam clean is intended to clean small spills using water and a lower cleaning temperature than Self-Clean.

To use the Steam Clean feature, wipe grease and soils from the oven. Pour one cup of water into the bottom of the oven. Close the door. Press the **Clean** pad **twice** and then press **Start**. The oven door will lock. You can not open the door during the 30 minute steam clean as this will decrease the steam clean performance. At the end of the steam clean cycle the door will unlock. Wipe out any excess water and any remaining soil.

### Self Clean Mode

Read Self-Cleaning Oven Safety Instructions at the beginning of this manual before using Self Clean Mode. Self clean uses very high temperatures to clean the oven interior. The oven door will lock when using this feature. Before operating the self clean cycle, wipe up grease and soils from the oven. Remove all items from the oven other than enameled (dark color) racks. Shiny or silver racks and any cookware or other items should all be removed from the oven before initiating a self-clean cycle. Close the door. Press the **Clean** pad once and a default self-clean time is displayed. The clean time can be changed to any time between 3:00 and 5:00 hours by using the number pads to enter a different time and pressing **Start**. For heavily soiled ovens, the maximum 5 hour clean time is recommended. If you wish to use the default time, press the **Start** pad immediately after pressing the **Clean** pad. The oven will turn off automatically when the self clean cycle is complete. The door will stay locked until the oven has cooled down. After the oven has cooled down wipe any ash out of the oven.

**IMPORTANT:** The health of some birds is extremely sensitive to the fumes given off during the self-cleaning cycle of any range. Move birds to another well-ventilated room.

The racks that were provided with your oven (dark enameled racks, not shiny) may remain in the oven during the self-cleaning cycle without being damaged.

To manually clean racks, use warm, soapy water. Make sure not to wash the rack slides on an extension rack.

If racks become more difficult to remove from the oven, put some vegetable oil on a soft cloth or paper towel and rub onto the oven rack supports. Do not wipe the oil on an extension rack slide.

Periodically, after several self-clean cycles, the extension rack slides may need to be lubricated using the graphite lubricant shipped with your wall oven. To order additional graphite lubricant read the Assistance and Accessories sections at the beginning of this manual.

1. Remove extension rack from the oven. See the Extension Oven Racks section.
2. Fully extend the rack on a table or countertop. Newspaper may be placed underneath the rack for easy clean up.
3. If there is debris in the slide tracks, wipe it away using a paper towel. **NOTE:** Any graphite lubricant wiped away must be replaced.

4. Shake the graphite lubricant before opening it. Starting with left slide mechanism of the rack, place four (4) small drops of lubricant on the two (2) bottom tracks of the slide close to the bearing carriers.

5. Repeat for the right slide mechanism of the rack.
6. Open and close the rack several times to distribute the lubricant.
7. Replace the cap on the lubricant and shake it again. Turn the rack over and repeat steps 3, 4, 5 and 6.
8. Close the rack, turn rack right-side-up and place in the oven. See the Extension Oven Racks section.
9. Repeat above steps for each rack.

**NOTE:** Do not spray with cooking spray or other lubricant sprays.

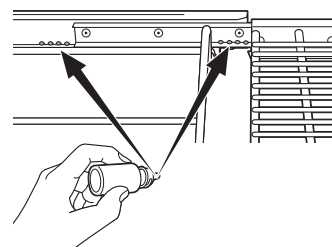
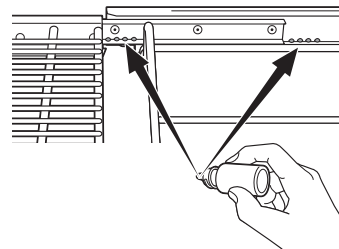
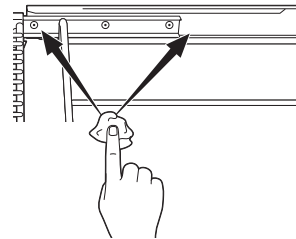
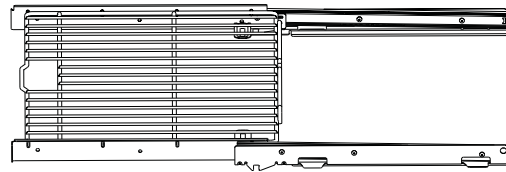

# Maintenance

Lower Oven

## Oven Light Replacement

### ⚠ WARNING

**SHOCK OR BURN HAZARD:** Before replacing oven light bulb, disconnect the electrical power to the oven at the main fuse or circuit breaker panel. Failure to do so may result in electric shock or burn.

### ⚠ CAUTION

**BURN HAZARD:** The glass cover and bulb should be removed when cool. Touching hot glass with bare hands or a damp cloth can cause burns.

1. Disconnect power at the main fuse or circuit breaker panel.
2. Remove oven racks.
3. Slide a flat blade screwdriver between the housing and the glass light cover.
4. Support the glass light cover with two fingers to prevent the cover from falling to the bottom of the oven. Be careful not to chip the oven coating.
5. Gently twist the screwdriver blade to loosen the glass light cover.
6. Remove the glass light cover.
7. Remove the bulb by firmly grasping and sliding the bulb straight out until the two prongs have cleared the ceramic holder.
8. Do not touch the glass of the new replacement bulb with your fingers. It will cause the bulb to fail when it lights. Grasp the replacement bulb with a clean towel or facial tissue with the prongs facing down. Align the two prongs in the ceramic holder, pressing gently until the bulb is securely in the ceramic socket.
9. Slide the protective lens into the holder and push until the clips snap into the housing.
10. Reconnect power.

## Lift-Off Oven Door

The door is very heavy. Be careful when removing and lifting the door.

Do not lift the door by the handle.

### To remove the door:

1. Fully open the door.
2. Pull the hinge locks down toward the door frame, to the unlocked position. A tool, such as a small flat-blade screwdriver, may be required.
3. Firmly grasp both sides of the door at the top.
4. Close door to the door removal position. The door should be open approximately 3" with no obstruction above the door.
5. Lift door up and out until both hinge arms are clear of the slots.

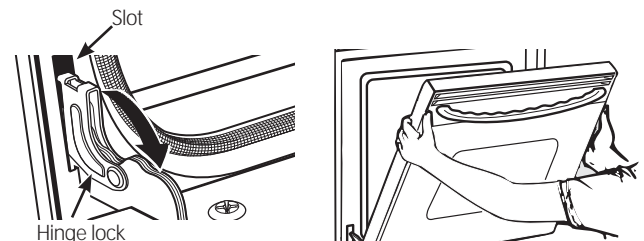

Pull hinge locks down to unlock

Removal position

### To replace the door:

1. Firmly grasp both sides of the door at the top.
2. Starting on the left side, with the door at the same angle as the removal position, seat the indentation of the hinge arm into the bottom edge of the hinge slot. The notch in the hinge arm must be fully seated into the bottom of the slot. Repeat for right side.
3. Fully open the door. If the door will not fully open, the indentation is not seated correctly in the bottom edge of the slot.
4. Push the hinge locks up against the front frame of the oven cavity, to the locked position.
5. Close the oven door.

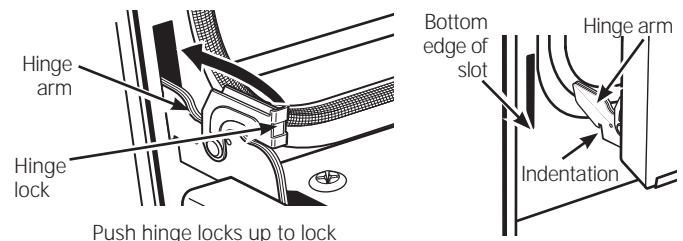

Push hinge locks up to lock

# Notes

---

# Notes

---



## Troubleshooting

### Upper Oven

Questions?  
Use this  
problem  
solver

Problem	Possible Causes	What To Do/Explanation
<b>LIGHTS</b>		
Light during a speedcook cycle dims and cycles on and off, even at full power levels	This is normal. Power level has been automatically reduced because the oven is hot.	<ul style="list-style-type: none"> <li>This is normal. The oven senses the heat level and adjusts automatically.</li> </ul>
Light visible around the door and outer case while speedcooking	This is normal.	<ul style="list-style-type: none"> <li>When the oven is on, light may be visible around the door and outer case.</li> </ul>
<b>FAN</b>		
Fan continues to run after cooking stops	The oven is cooling.	<ul style="list-style-type: none"> <li>The fan will automatically shut off when the internal parts of the oven have cooled.</li> </ul>
Oven vent emits warm air while oven is on	This is normal.	
Fan comes on automatically when using the microwave	This is normal.	
<b>COOKING</b>		
The oven makes unusual sounds while cooking	Clicks and fans blowing are normal. The relay board is turning the components on and off.	<ul style="list-style-type: none"> <li>These sounds are normal.</li> </ul>
Smoke comes out of the oven when I open the door	Food is high in fat content. Aerosol spray used on the pans.	<ul style="list-style-type: none"> <li>Smoke is normal when cooking high-fat foods.</li> </ul>
Food is not fully cooked or browned at the end of a cooking program	Programmed times may not match the size or amount of food you are cooking.	<ul style="list-style-type: none"> <li>Adjust time for doneness or adjust the upper or lower lamps for browning and doneness.</li> </ul>
<b>SENSOR ERROR displayed along with an oven signal</b>	Food amount or type placed in the oven does not match the program that was set.	<ul style="list-style-type: none"> <li>Press the CLEAR/OFF pad. Set the oven program to match the food or liquid to be cooked or heated.</li> </ul>
	Steam was not sensed by the oven because plastic wrap was not vented, a lid too tight was on the dish or a liquid was covered.	<ul style="list-style-type: none"> <li>Vent plastic wrap, use a looser lid or uncover liquids when cooking or heating.</li> </ul>

## Troubleshooting

Upper Oven

Questions?  
Use this  
problem  
solver

Problem	Possible Causes	What To Do/Explanation
<b>DISPLAY</b>		
The display is blank	Power saver mode may be activated.	<ul style="list-style-type: none"> <li>Check the SETTINGS menu for clock display settings. Turn the display on.</li> </ul>
"Control is LOCKED" appears in display	The control has been locked.	<ul style="list-style-type: none"> <li>Press and hold CLEAR/OFF for 3 seconds to unlock the control.</li> </ul>
Control display is lit yet oven will not start	Clock is not set.	<ul style="list-style-type: none"> <li>Set the clock.</li> </ul>
	Door not securely closed.	<ul style="list-style-type: none"> <li>Open the door and close securely.</li> </ul>
	START/PAUSE pad or dial not pressed after entering cooking selection.	<ul style="list-style-type: none"> <li>Press START/PAUSE or dial.</li> </ul>
	Another selection already entered in oven and CLEAR/OFF pad not pressed to cancel it.	<ul style="list-style-type: none"> <li>Press CLEAR/OFF.</li> </ul>
	Size, quantity or cooking time not entered after final selection.	<ul style="list-style-type: none"> <li>Make sure you have entered cooking time after selecting.</li> </ul>
	CLEAR/OFF was pressed accidentally.	<ul style="list-style-type: none"> <li>Reset cooking program and press START/PAUSE.</li> </ul>
<b>OTHER PROBLEMS</b>		
The door and inside of the oven feels hot	The heat lamps produce intense heat in a small space.	<ul style="list-style-type: none"> <li>This is normal.</li> <li>Use oven mitts to remove food when when ready.</li> </ul>
Oven will not start	A fuse in your home may be blown or the circuit breaker tripped.	<ul style="list-style-type: none"> <li>Replace fuse or reset circuit breaker.</li> </ul>

Problem	Possible Cause	What To Do
Cannot edit cooking features	Some pre-programmed cooking features may not be able to be edited to prevent degradation of cooking performance.	This is normal.

Problem	Possible Cause	What To Do
Display goes blank	A fuse in your home may be blown or the circuit breaker tripped.	Replace the fuse or reset the circuit breaker.
	Power outage or surge	Reset the clock. If the oven was in use, you must reset it by pressing the <b>Clear/Off</b> pad, setting the clock and resetting any cooking function.

# Troubleshooting tips ... Before you call for service

Lower Oven

Save time and money! Review the charts on the following pages first and you may not need to call for service.

Problem	Possible Cause	What To Do
My new oven doesn't cook like my old one. Is something wrong with the temperature settings?	Your new oven has a different cooking system from your old oven and therefore may cook differently than your old oven.	For the first few uses, follow your recipe times and temperatures carefully. If you still think your new oven is too hot or too cold, you can adjust the temperature yourself to meet your specific cooking preference. <b>NOTE:</b> This adjustment affects Bake, Convection Bake 1 Rack and Convection Bake Multi temperatures; it will not affect Convection Roast, Broil, or Clean.
Food does not bake properly	Oven controls improperly set.	See the Cooking Modes section.
	Rack position is incorrect or rack is not level.	See the Cooking Modes section and Cooking Guide.
	Incorrect cookware or cookware of improper size being used.	See the Cookware section.
	Oven temperature needs adjustment.	See the Special Features section.
	Ingredient substitution	Substituting ingredients can change the recipe outcome.
Food does not broil properly	Oven controls improperly set.	Make sure you select the appropriate broil mode.
	Improper rack position being used.	See Cooking Guide for rack location suggestions.
	Food being cooked in a hot pan.	Make sure cookware is cool.
	Cookware not suited for broiling.	Use a pan specifically designed for broiling.
	Aluminum foil used on the broiling pan and grid has not been fitted properly and slit as recommended.	If using aluminum foil conform to pan slits.
	In some areas the power (voltage) may be low.	Preheat the broil element for 10 minutes.
Oven temperature too hot or too cold	Oven temperature needs adjustment.	See the Special Features section.
Oven does not work or appears not to work	A fuse in your home may be blown or the circuit breaker tripped.	Replace the fuse or reset the circuit breaker.
	Oven controls improperly set.	See the Using the Oven section.
	Oven is in Sabbath Mode.	Verify, that the oven is not in Sabbath Mode. See the Special Features section.
"Crackling" or "popping" sound	This is the sound of the metal heating and cooling during both the cooking and cleaning functions.	This is normal.
Why is my range making a "clicking" noise when using my oven?	Your range has been designed to maintain a tighter control over your oven's temperature. You may hear your oven's heating elements "click" on and off more frequently than in older ovens to achieve better results during baking, broiling, convection, and self-clean cycles.	This is normal.
Clock and timer do not work	A fuse in your home may be blown or the circuit breaker tripped.	Replace the fuse or reset the circuit breaker.

# Troubleshooting tips ... Before you call for service

Lower Oven

Problem	Possible Cause	What To Do
Oven light does not work	Light bulb is loose or defective.	Tighten or replace bulb.
	Pad operating light is broken.	Call for service.
Oven will not self-clean	The temperature is too high to set a self-clean operation.	Allow the oven to cool and reset the controls.
	Oven controls improperly set.	See the Cleaning the Oven section.
Excessive smoking during clean cycle	Excessive soil or grease.	Press the <b>Clear/Off</b> pad. Open the windows to rid the room of smoke. Wait until the <b>LOCKED</b> light goes off. Wipe up the excess soil and reset the clean cycle.
Excessive smoking during broiling	Food too close to burner element.	Lower the rack position of the food.
Oven door will not open after a clean cycle	Oven too hot.	Allow the oven to cool below locking temperature.
Oven not clean after a clean cycle	Oven controls improperly set.	See the Cleaning the Oven section.
	Oven was heavily soiled.	Clean up heavy spillovers before starting the clean cycle. Heavily soiled ovens may need to self-clean again or for a longer period of time.
"LOCK DOOR" flashes in the display	The self-clean cycle has been selected but the door is not closed.	Close the oven door.
"DOOR IS LOCK" show on display section	The oven door is locked because the temperature inside the oven has not dropped below the unlocking temperature.	Press the <b>Clear/Off</b> pad. Allow the oven to cool.
An oven error and "SERVICE MAYBE NEEDED" show in the display	You have a function error code.	Press the <b>Clear/Off</b> pad. Allow the oven to cool for one hour. Put the oven back into operation.
	If the function code repeats.	Disconnect all power to the oven for at least 30 seconds and then reconnect power. If the function error code repeats, call for service.
"Burning" or "oily" odor emitting from the vent	This is normal in a new oven and will disappear in time.	To speed the process, set a self-clean cycle for a minimum of 3 hours. See the Cleaning the Oven section.
Strong odor	An odor from the insulation around the inside of the oven is normal for the first few times the oven is used.	This is temporary and will go away after several uses or a self-clean cycle.
Fan noise	A cooling fan may automatically turn on.	This is normal. The cooling fan will turn on to cool internal parts. It may run for up to 1-1/2 hours after the oven is turned off.
My oven door glass appears to be "tinted" or have a "rainbow" color. Is this defective?	No. The inner oven glass is coated with a heat barrier to reflect the heat back into the oven to prevent heat loss and keep the outer door cool while baking.	This is normal. Under certain light or angles, you may see this tint or rainbow color.
Sometimes the oven takes longer to preheat to the same temperature	Cookware or food in oven	The cookware or food in the oven will cause the oven to take longer to preheat. Remove items to reduce preheat time.
	Number of racks in oven	Adding more racks to the oven will cause the oven to take longer to preheat. Remove some racks.
	Different cooking modes	The different cooking modes use different preheat methods to heat the oven for the specific cooking mode. Some modes will take longer than others (i.e. convection bake multi).