

FRIGIDAIRE

All about the

Use & Care

of your Wall Oven



TABLE OF CONTENTS

Product Record and Registration	2	Care and Cleaning	25
Important Safety Instructions	3	Before You Call	30
Before Setting Oven Controls	7	Warranty	33
Setting Oven Controls	9		

PRODUCT RECORD AND REGISTRATION

Need Help?	2
Product Registration	2
Product Record and Registration	2
Important Safety Instructions	3
Before Setting Oven Controls	7
Setting Oven Controls	9
Care and Cleaning	25
Before You Call	30
Warranty	33

Need Help?

Visit the Frigidaire web site at www.frigidaire.com

Before you call for service, there are a few things you can do to help us serve you better.

Read this Use & Care Manual

This manual contains instructions to help you use and maintain your oven properly.

If You Received a Damaged Oven...

Immediately contact the dealer (or builder) that sold you the oven.

Save Time and Money

Check "[Solutions to Common Problems](#)" on page 31. This section helps step you through some common problems that might occur.

If you do need service, help is only a phone call away. Call Frigidaire customer services at **1-800-944-9044**.

Product Registration

Registering your product with Frigidaire enhances our ability to serve you. You can register online at <http://www.frigidaire.com> or by dropping your product registration card in the mail.

Record model and serial numbers here

Purchase Date: _____

Frigidaire model number: _____

Frigidaire serial number: _____

Serial Plate Location

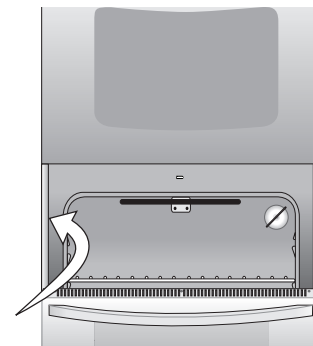

Questions?

For toll-free telephone support in the U.S. and Canada call **1-800-944-9044**

For online support and product information visit <http://www.frigidaire.com>.

Thank you for choosing Frigidaire.

This Use & Care manual is part of our commitment to customer satisfaction and product quality throughout the service life of your new appliance. We view your purchase as the beginning of a relationship. To ensure our ability to continue serving you, please use this page to record important product information.

IMPORTANT SAFETY INSTRUCTIONS

CAUTIONS AND WARNINGS

Read all instructions before using this appliance.

This manual contains important safety symbols and instructions. Please pay attention to these symbols and follow all instructions given.

Do not attempt to install or operate your appliance until you have read the safety precautions in this manual. Safety items throughout this manual are labeled with a WARNING or CAUTION statement based on the risk type.

DEFINITIONS

 This is the safety alert symbol. It is used to alert you to potential personal injury hazards. Obey all safety messages that follow this symbol to avoid possible injury or death.

WARNING

Indicates a potentially hazardous situation which, if not avoided, may result in death or serious injury.

CAUTION

Indicates a potentially hazardous situation which, if not avoided, may result in minor or moderate injury.

IMPORTANT

Indicates installation, operation, maintenance, or valuable information that is not hazard related.

NOTE

Indicates a short, informal reference—something written down to assist the memory or for future reference.

WARNING

Storage in or on appliance—Flammable materials should not be stored in an oven or near surface units. This includes paper, plastic, and cloth items, such as cookbooks, plastic ware, and towels, as well as flammable liquids. Do not store explosives, such as aerosol cans, on or near the oven.

WARNING

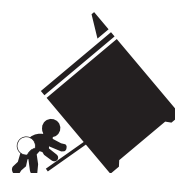

Tip Over Hazard

- A child or adult can tip the oven and be killed.
- Install the anti-tip device to oven and/or structure per installation instructions.
- Ensure the anti-tip device is re-engaged when the oven is moved.
- Do not operate the oven without the anti-tip device in place and engaged.
- Failure to follow these instructions can result in death or serious burns to children and adults.

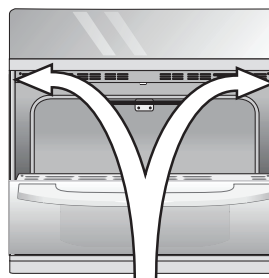

Anti-tip mounting holes

Refer to the installation instructions supplied with your appliance for proper installation.

Check for proper installation with a visual check that the anti-tip screws are present. Test the installation with light downward pressure on the open oven door. The oven should not tip forward.

Save these instructions for future use.

IMPORTANT SAFETY INSTRUCTIONS

WARNING

- Do not leave children alone - Children should not be left alone or unattended in the area where appliance is in use. They should never be allowed to sit or stand on any part of the appliance, including the storage drawer, lower broiler drawer, warmer drawer, or lower double oven.
- Stepping, leaning, or sitting on the door or drawers of an oven can result in serious injuries and also cause damage to the appliance. Do not allow children to climb or play around the oven. The weight of a child on an open oven door may cause the oven to tip, resulting in serious burns or other injury.
- Never cover any slots, holes, or passages in the oven bottom or cover an entire oven rack with materials such as aluminum foil. Aluminum foil linings may trap heat, causing a fire hazard.

IMPORTANT

- Important Safety Notice - The California Safe Drinking Water and Toxic Enforcement Act requires the governor of California to publish a list of substances known to cause cancer, birth defects, or other reproductive harms, and it requires businesses to warn customers of potential exposures to such substances.
- Do not attempt to operate the oven during a power failure. If the power fails, always turn off the oven. If the oven is not turned off and the power resumes, the oven will begin to operate again. Once the power resumes, reset the clock and oven function.
- Cold temperatures can damage the electronic control. When using this appliance for the first time, or when the appliance has not been used for an extended period of time, be sure the appliance has been in temperatures above 32°F (0°C) for at least 3 hours before turning on the power to the appliance.

IMPORTANT

Read and follow the below instructions and precautions for unpacking, installing, and servicing your appliance:

- Remove all tape and packaging before using the oven. Destroy the carton and plastic bags after unpacking the oven. Never allow children to play with packaging material.
- Proper installation—Be sure your appliance is properly installed and grounded by a qualified technician in accordance with the National Electrical Code ANSI/NFPA No. 70 latest edition and local electrical code requirements. In Canada, install in accordance with CSA Standard C22.1, Canadian Electrical code, Part 1, and local electrical code requirements. Install only per installation instructions provided in the literature package for this oven.
- User servicing—Do not repair or replace any part of the appliance unless specifically recommended in the manuals. All other servicing should be done only by a qualified technician. This reduces the risk of personal injury and damage to the oven.
- Ask your dealer to recommend a qualified technician and an authorized repair service. Know how to disconnect the power to the oven at the circuit breaker or fuse box in case of an emergency.
- Never modify or alter the construction of an oven by removing the leveling legs, panels, wire covers, anti-tip brackets/screws, or any other part of the oven.
- Remove the oven door from any unused oven if it is to be stored or discarded.
- Be sure to have an appropriate foam-type fire extinguisher available, visible, and easily located near the appliance.

Save these instructions for future use.

IMPORTANT SAFETY INSTRUCTIONS

CAUTION

- Do not store items of interest to children in the cabinets above the appliance. Children climbing on the appliance to reach items could be seriously injured.
- Do not heat unopened food containers. Build-up of pressure may cause container to burst and result in injury.
- When heating fat or grease, watch it closely. Grease may catch fire if it becomes too hot.
- Do not use water or flour on grease fires. Smother fire or flame or use dry chemical or foam-type extinguisher. Cover the fire with a pan lid or use baking soda.
- Use dry potholders. Moist or damp potholders on hot surfaces may result in burns from steam. Do not let potholders touch hot cooking areas. Do not use towels or other bulky cloths.
- Wear proper apparel - Loose-fitting or hanging garments should never be worn while using the appliance.
- Do not touch heating elements or interior surfaces of oven - Heating elements may be hot even though they are dark in color. Interior surfaces of an oven become hot enough to cause burns.
- During and after use, do not let clothing or other flammable materials contact hot surfaces of the oven until they have had sufficient time to cool. Other surfaces of the appliance may become hot enough to cause burns - among these surfaces are (identification of surfaces - for example, oven vent openings and surfaces near these openings, oven doors, and windows of oven doors).

IMPORTANT INSTRUCTIONS FOR USING YOUR OVEN

- Never use your appliance for warming or heating the room.
- Use care when opening oven door, lower oven door, or warmer drawer (some models). Stand to the side of the oven when opening the door of a hot oven. Let hot air or steam escape before you remove or replace food in the oven.
- Keep oven vent ducts unobstructed. Touching surfaces in this area when the oven is on may cause severe burns.
- Do not place plastic or heat-sensitive items on or near the oven vent. These items can melt or ignite.
- Placement of oven racks - Always place oven racks in desired location while oven is cool. If rack must be moved while oven is hot, do not let potholder contact hot heating element in oven. Use potholders and grasp the rack with both hands to reposition.
- Do not let potholders contact the hot heating elements in the oven. Remove all bakeware before moving the rack.
- Do not use a broiler pan without its insert. Broiler pans and inserts allow dripping fat to drain away from the high heat of the broiler. Do not cover the broiler insert with aluminum foil; exposed fat and grease could ignite.
- Protective liners - Do not use aluminum foil or any other materials to line oven bottoms, except as suggested in the manual. Improper installation of these liners may result in a risk of electric shock, or fire.
- Do not cook food on the oven bottom. Cook in proper bakeware and always use the oven racks.

Save these instructions for future use.

IMPORTANT SAFETY INSTRUCTIONS

IMPORTANT INSTRUCTIONS FOR CLEANING YOUR OVEN

CAUTION

Before manually cleaning any part of the oven, be sure all controls are turned off and the oven is cool. Cleaning a hot oven can cause burns.

- Clean the oven regularly to keep all parts free of grease that could catch fire. Do not allow grease to accumulate.
- Always follow the manufacturer's recommended directions for use of kitchen cleaners and aerosols. Be aware that excess residue from cleaners and aerosols may ignite causing damage and injury.
- Clean ventilating hoods frequently. Grease should not be allowed to accumulate on the hood or filter. Follow the manufacturer's instructions for cleaning hoods.

SELF CLEANING OVENS

- Clean only the parts listed in this manual. Before using self clean, remove the broiler pan, any food, utensils, and cookware from the oven.
- Do not use oven cleaners. No commercial oven cleaner or oven liner protective coating of any kind should be used in or around any part of the appliance.
- Do not clean the oven door gasket. The door gasket is essential for a good seal. Care should be taken not to rub, damage, or move the gasket.
- Some birds are extremely sensitive to the fumes given off during the self clean cycle of any oven. Move birds to another well-ventilated room.
- Remove oven racks. If left in the oven during a self cleaning cycle the oven racks color will change.

GROUNDING INSTRUCTIONS

WARNING

Avoid fire hazard or electrical shock. Failure to follow this warning may cause serious injury, fire, or death.

This appliance must be supplied with the proper voltage and frequency, and connected to an individual, properly grounded branch circuit, protected by a circuit breaker or fuse.

It is the responsibility and obligation of the consumer to contact a qualified installer to assure that the electrical installation is adequate and is in conformance with all local codes and ordinances.

See the installation instructions packaged with this appliance for complete installation and grounding instructions.

Save these instructions for future use.

BEFORE SETTING OVEN CONTROLS

Oven Vent Location

The oven is vented as shown below. When the oven is on, warm air is released through the vent. This venting is necessary for proper air circulation in the oven and good baking results. Do not block oven vent. Never close off the openings with aluminium foil or any other material. Steam or moisture may appear near the oven vent; this is normal.

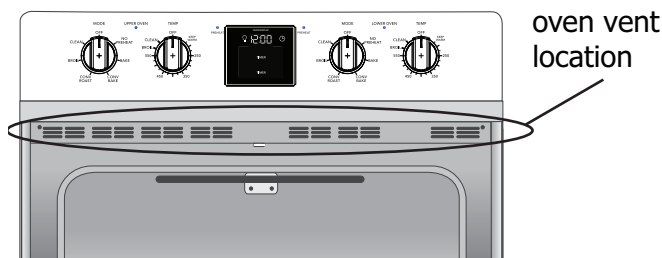
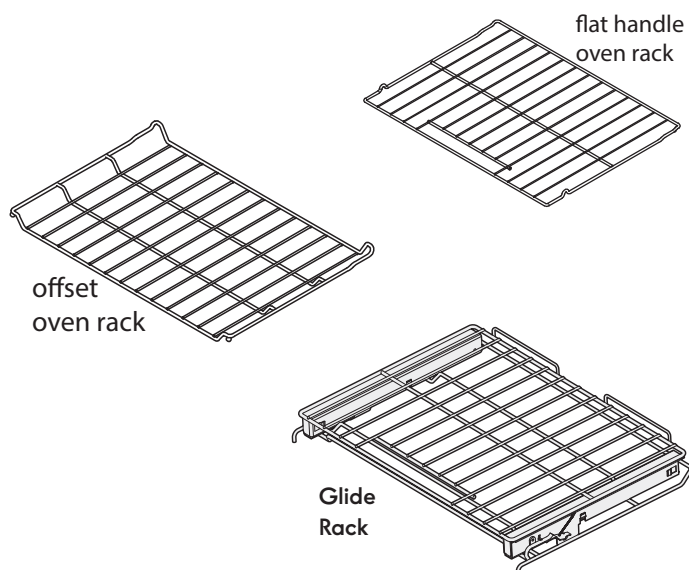

Figure 1: Do not block oven vent location

Type of oven racks



CAUTION

Always use pot holders or oven mitts when using the oven. When cooking, the oven interior and exterior, oven racks, and cooktop will become very hot which can cause burns.

WARNING

Protective Liners — Do not use aluminum foil or any other materials to line the oven bottom, walls, racks or any part of the oven. Only use aluminum foil as recommended in this manual. Improper installation of these liners may result in risk of electric shock or fire.

IMPORTANT

All oven racks should be removed before a self clean operation. Racks left in the oven during the high heat of the self clean function can easily discolor.

The ability of the racks to easily slide in and out along the rack positions may also be affected.

Oven Rack Descriptions

- **Flat oven racks** (or the **flat handle** oven rack) may be used for most cooking needs and may be placed in most oven rack positions.
- The **offset oven rack** (some models) provides additional step down positions from the standard flat rack design. The offset design positions the base of the rack about $\frac{1}{2}$ of a rack position lower than the flat rack and may be used in most oven rack positions.
- The fully extendable oven **glide rack** allows you to effortlessly extend your food away from the oven.

Removing, replacing, and arranging flat or offset oven racks

To arrange - Always arrange the oven racks when the oven is cool (prior to operating the oven).

To remove - Pull the oven rack straight forward until it reaches the stop position. Lift up front of oven rack slightly and slide out.

To replace - Place the oven rack on the rack guides on both sides of oven walls. Tilt the front of oven rack upward slightly and slide the oven rack back into place. Be sure oven racks are level before using.

BEFORE SETTING OVEN CONTROLS

Removing and Replacing the Glide Racks

The fully extendable Glide rack makes food preparation easier. This oven rack has glide tracks that allow the rack to be pulled away from the oven without rubbing the sides of the oven wall.

To remove - Using one hand, reach through handle opening and lift up on the release lever located across the lower front of the rack as shown in [Figure 2](#).

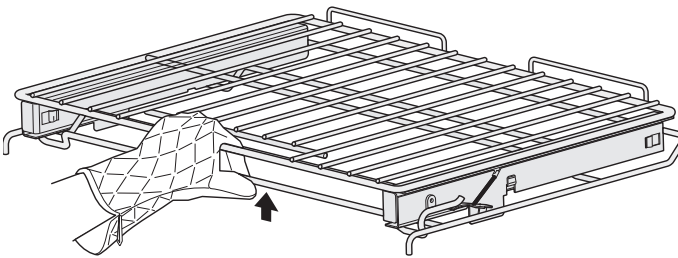

Figure 2: Grasp handle and lift up on bar

While holding up the release lever, pull the glide rack out of the oven until the stop position is reached ([Figure 3](#))

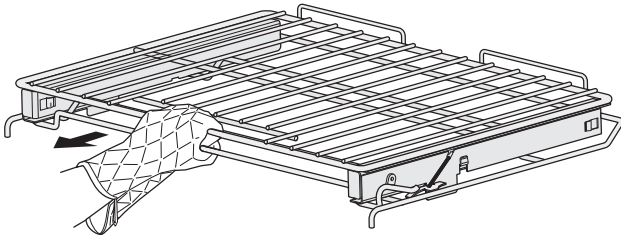

Figure 3: Pull rack to stop position

Using both hands, grasp the upper and lower portions of the glide rack. Lift up the front of the rack slightly and continue to pull the rack away from the oven ([Figure 4](#)). Be sure to grasp both upper and lower rack portions together when removing or handling the glide rack.

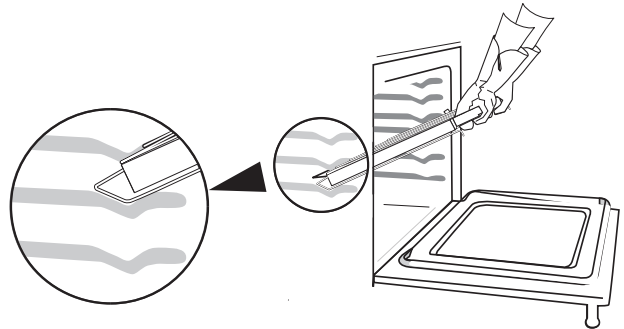

Figure 4: Remove and replace using both hands

The rack portions move independently and are difficult to handle unless held together.

To replace - grasp both upper and lower portions of glide rack, lift and hold the rack level between the oven cavity walls. Tilt the front of the rack upward slightly and slide the rack completely into position.

Important: To prevent possible damage to the oven, do not attempt to close the oven door until all the oven racks are fully positioned back inside the oven cavity.

➔ IMPORTANT

Do not line the oven walls, racks, bottom or any other parts of the oven with aluminum foil or with any other materials or oven liners. Doing so will alter heat distribution and may cause permanent damage to the oven interior. During clean the oven temperatures will be hot enough to melt foil.

⚠ CAUTION

Remove all oven racks and clean according to instructions provided in the Care & Cleaning section of this manual. Never pick up hot oven racks or parts.

T

SETTING OVEN CONTROLS

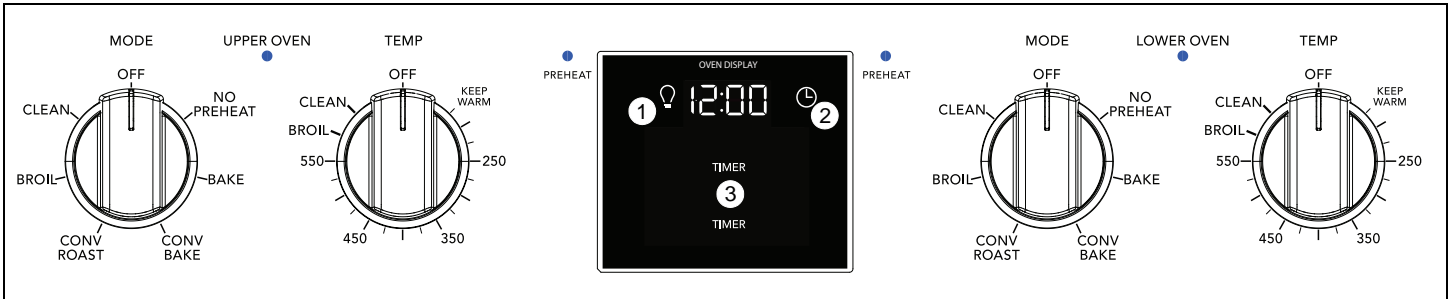

OVEN MODE SETTINGS

NO PREHEAT - Use no preheat for single rack items only and place food in center of oven before setting temperature.

BAKE - Use to select bake function before setting temperature.

CLEAN - Use to select clean feature cycle before setting clean with oven temperature selector.

CONV BAKE - Use to select convection baking before setting oven temperature.

CONV ROAST - Use to select convection roast for beef, lamb, pork, and poultry before setting oven temperature.

BROIL - Use to set broil feature before setting broil with oven temperature selector.

KEEP WARM - Set BAKE, CONV BAKE, or CONV ROAST mode, then set KEEP WARM with oven temperature selector. Keep warm provides a low heat for keeping cooked foods at serving temperature.

OVEN DISPLAY FEATURES

- Oven light** - Use to turn on the internal oven light.
- Clock** - Use to set the time of day.
- TIMER** - Use to set or cancel the minute timer. The minute timer does not start or stop any cooking function.

OVEN TEMP SETTINGS - Use to set oven temperatures between 170°F (KEEP WARM) and 550°F. The CLEAN setting should only be used after reading all cautions and warnings in [“Self Cleaning”](#) on [page 22](#).

Oven Minimum and Maximum Control Settings

Feature	Min. Temp/Time	Max. Temp/Time
BAKE	170°F (77°C) (KEEP WARM)	550°F (288°C)
NO PREHEAT	200°F (93°C)	550°F (288°C)
CONV BAKE	170°F (77°C) (KEEP WARM)	550°F (288°C)
CONV ROAST	170°F (77°C) (KEEP WARM)	550°F (288°C)
MEAT PROBE	140°F (60°C)	210°F (99°C)
BROIL	550°F (288°C)	
TIMER	0:01 Hr	11:59
CLOCK (12hr)	1:00 Hr	12:59 Hr

User Preference Settings

The default (factory) settings for sounds, energy saving, temperature offset, and convection convert are pre-set in the oven control. These may be changed by accessing the user preference display while the oven is in the idle mode and no timers are active.

Once the user preference menu is activated, the user can make changes and scroll through a menu of options, choosing from **AUd** (audible control setting), **ES** (energy saving), **UPO** (User Programmable Offset for changing the oven temperature), **Aut** (automatic convection convert), and **dEF** (default) setting with **rSt** reset choice (which will allow all preferences to reset to default settings).

SETTING OVEN CONTROLS

Setting the Clock

The clock icon is used to access the time of day setting. When the oven is first plugged in or if there has been an interruption in power to the oven, **12:00** will flash in the display.

To set the correct time of day:

1. Press the clock icon.
2. The display will show a time along with a **–** and a **+** key in the display below.
3. Press either **–** or **+** key to scroll to the correct time of day and release the key.
4. The control will accept the new set time with a chime, and the control will show the time of day along with the two timers that are available.

NOTE

The clock cannot be changed when the oven is set for cooking or self clean is active. Only a 12 hour clock is available on the Frigidaire Professional model.

Oven Light

The oven lights will turn on automatically in both ovens when either oven door is opened. The oven lights may be turned on when the door is closed by using the oven light key located on the control panel. This will turn on both oven lights.

Note: Keep oven light off while baking. The oven light will turn off during a clean cycle and not operate.

To toggle the oven lights on and off:

1. Press oven light symbol .

The interior oven light is covered with a glass shield. The glass shield must be in place whenever the oven is in use.

To change the interior oven lights, see [“Replacing the Oven Light”](#) in the Care & Cleaning section.

Setting the Timer

The minute timers in the oven display serve as extra timers to help keep track of cooking functions. The timer cannot be used during a self clean cycle or if the meat probe function associated with the timer display is in use. The minimum timer setting is 1 minute and the maximum setting is 11:59 (HR:MIN).

To set the timer:

1. Press either **TIMER** key.
2. The timer display will show **0:00** and the **–** and **+** keys on either side of the time display. **NOTE:** If the **–** key is pressed at this time an invalid key chime will sound.
3. Press the **+** key to begin to scroll to the desired setting. If the **+** key is held, the timer value will increase rapidly. Once the desired setting is reached, release the key and the timer will start counting down automatically after a short time-out.
4. The timer display will show the **H:M** icon if the timer is set for more than 1 minute. If the value is under 1 minute, the timer will display the time in seconds and the **H:M** icon will not appear.
5. When the timer ends, a reminder chime will sound and repeat once every 60 seconds for a period of five minutes. Before the user can program an expired timer again, the timer key must be pressed.
6. To cancel the timer before the set time expires, press the **TIMER** key.

NOTE

The minute timers will not start or stop the cooking process. The minute timers can be used alone or while using most of the other oven features.

SETTING OVEN CONTROLS

Setting Continuous Bake or 6 Hour Energy Saving

The oven is preset to cook up to 6 hours and to shut off automatically. For longer periods of cooking, this feature can be changed to continuous cooking by setting the user preference and turning the energy saving feature off.

To set the oven for continuous cooking:

1. Press and hold both the **light** icon and the **clock** icon at the same time for a few seconds until the display sounds an acceptance chime and the display will show one of the user preferences.
2. Press the **+** key in the upper part of the display until **ES** appears and **ON** is showing.



Figure 5: Energy saving with ON and OFF options

3. To turn the energy saving feature **off**, press the **+** or **-** key in the lower part of the display and **OFF** will appear in the display.
4. The control will accept the change in a few seconds and sound the acceptance chime. The oven is now set for continuous cooking.
5. To return to the time of day display, press and hold the **light** and **clock** icons at the same time for a few seconds until the display chimes and fades back to showing the time of day in the display.

Setting Control for Silent Operation

The oven is set to operate with certain chimes and tones (default settings) that alert the user to certain oven functions. The silent operation feature allows the oven control to be operated without sounds when necessary. By accessing user preferences, this option can be later returned to operate with normal programming sounds.

To set the oven control for silent operation:

1. Press and hold both the **light** icon and the **clock** icon at the same time for a few seconds until the display sounds an acceptance chime. **AUd** should appear in the display.
2. If **Aud** is not showing, press the **+** key in the upper part of the display until **AUd** appears and **HI** is showing in the lower part of the display. This is the normal (default) setting.



Figure 6: Default setting for oven control sounds

3. To turn the audible feature to a lower sound or completely **OFF**, press the **+** or **-** key in the lower part of the display until **LO** or **OFF** appears in the display.



Figure 7: Lowest audible setting (L) and OFF

4. When the desired setting appears in the display, release the key and wait for an acceptance chime.
5. To return to the time of day display, press and hold both the **light** and **clock** icons at the same time for a few seconds until the display chimes and fades back to showing the time of day.

SETTING OVEN CONTROLS

Setting No Preheat

Use the No Preheat feature when you want to start baking immediately, without the need for preheating. No Preheat provides good results when preparing convenience foods such as cinnamon rolls, frozen pizza, bacon, french fries, and tater tots. Food will finish cooking in the time stated in the package directions without the extra time required for preheating.

During No Preheat the convection fan will pulse on and off, and the bake element will cycle on and off to maintain the set temperature for precise baking.

No Preheat is designed for baking on a single rack placed in the center of the oven and may be set for any temperature from 200°F to 550°F.

Important: For batter and dough-based baked goods such as cakes, pastries, and breads, use the convection function for best results.

No Preheat tips for best results:

- Always place the food in the center of the oven on rack position 3 (Figure 8). No Preheat is designed for baking on a single oven rack.
- When using No Preheat, use bakeware with low or no sides. This allows the air to circulate around the food evenly.
- Food that comes in strips, such as fish sticks and chicken tenders, should be placed on the pan with the ends pointing to the sides of the oven.
- Follow the package directions for food preparation time and temperature. No Preheat works best when cooking foods longer than 10 minutes. If directions call for a shorter cooking time, a few extra minutes may be required for optimal cooking results.
- Do not open the oven door often. Opening the door will reduce the temperature in the oven and may increase bake time.

! CAUTION

Always use potholders or oven mitts when using the oven. When cooking, the oven interior will become hot and could cause burns.

To set No Preheat:

1. Remove food from packaging and arrange on baking pan.
2. Place pan in oven on rack position 3 and close oven door.
3. Turn the oven mode selector to **No Preheat**.
4. Turn the oven temperature selector to the desired temperature. Baking will begin immediately.
5. To stop baking turn the oven mode selector and oven temperature selector to the **OFF** positions.

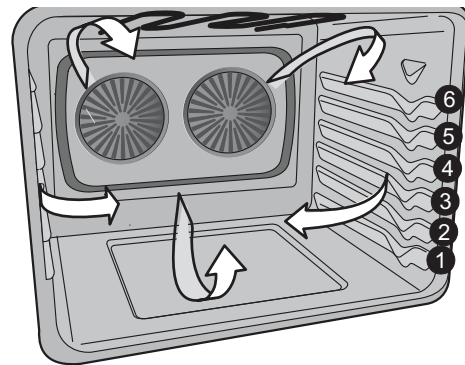

Figure 8: Use rack position 3 for No Preheat baking

SETTING OVEN CONTROLS

Setting Bake

Use the **Bake** function whenever a recipe calls for baking using normal temperatures. Bake may be set for any temperature between 170°F and 550°F.

During Bake, convection fan will pulse on and off, and the bake element will cycle on and off to maintain the set temperature for precise baking.

Important: For batter and dough-based baked goods such as cakes, pastries, and breads, use the convection function for best results.

For best Bake results:

- Fully preheat the oven before baking items like cookies, cakes, biscuits, and breads.
- For single rack baking, position rack so food is in the center of the oven.
- Leave oven light off while baking.
- For best results when baking cookies using two oven racks, place the glide rack in position 5 and the flat rack in position 3.
- For best results when baking cakes using two oven racks, place Glide rack in position 4 with flat rack in position 1. (See [Figure 9](#)).
- Position cookware as shown in [Figure 10](#). Allow at least 2-4 inches (5-10 cm) of space between cookware for proper air circulation when using multiple racks.
- Dark or dull bakeware absorbs more heat than shiny bakeware. It may be necessary to reduce oven temperature and cook time to prevent overbrowning.
- Dark bakeware is recommended for pies. Shiny bakeware is recommended for cakes, cookies, and muffins.
- Do not open oven door too often. Doing so reduces oven temperature and may extend cooking time.

To set a bake for 350°F:

1. Arrange oven racks.
2. Turn the oven mode selector to **Bake**.
3. Turn the oven temperature selector to **350°F**.
4. When the oven reaches 350° the **PREHEAT** light will turn off and a reminder chime will alert you to place food in oven.
5. When finished baking, be sure to return both the temperature selector knob and the oven mode knob to the **OFF** positions.

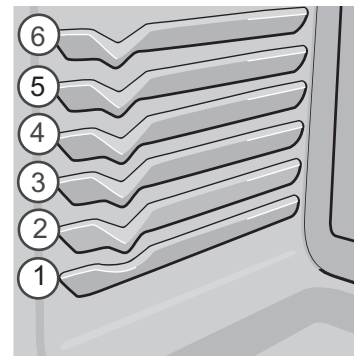

Figure 9: Rack positions

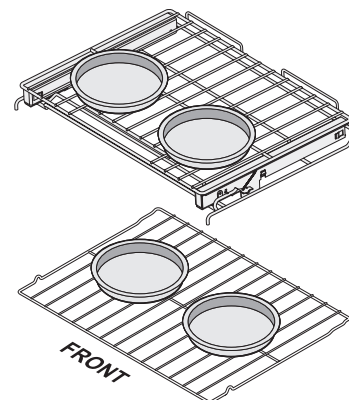

Figure 10: Pan spacing for two rack baking

SETTING OVEN CONTROLS

Convection Baking

Convection baking enables you to obtain the best results when baking with multiple pans and racks. The oven can be programmed for convection baking at any temperature between 170°F to 550°F. The convection function uses a fan to circulate the oven heat uniformly and continuously around the oven (Figure 11). This improved heat distribution allows for fast, even cooking and browning results. It also gives better baking results when using two oven racks at the same time. During convection baking, the convection fan may pulse on and off to maintain the set temperature for precise baking.

Benefits of convection cooking:

- Multiple rack baking.
- Some foods may cook faster, saving time and energy.

Convection baking tips:

- Because most food items will cook faster and more evenly with the convection feature, it is advisable to reduce recipe's recommended temperature by 25° for best results. Follow the recipe's instructions using the minimum recommended cook time.
- Fully preheat the oven before baking items like cookies, cakes, biscuits, and breads. Convection baking will produce the best results when baking these items.
- For single rack baking, position the rack so that food is in the center of the oven.
- If your recipe cooking temperature has already been converted for convection baking, there is no need to reduce your oven temperature. If not, see "[Setting Convection Convert](#)" on page 15 for further instructions on temperature conversion.
- For best results when baking cookies using two oven racks, place the glide rack in position 5 and the flat rack in position 3.
- For best results when baking cakes using two oven racks, place Glide rack in positions 5 with offset rack in position 1. (See Figure 11).
- When baking using two oven racks, position cookware as shown in Figure 12. Allow at least 2 inches (5 cm) of space between cookware for proper air circulation.
- Dark or dull bakeware absorbs more heat than shiny bakeware. It may be necessary to reduce oven temperature and cook time to prevent overbrowning of some foods. Dark bakeware is recommended for pies. Shiny bakeware is recommended for cakes, cookies, and muffins.

- Do not open oven door too often. Doing so reduces oven temperature and may extend cooking time.
- Most baked goods (except cakes) should be baked on pans with no sides or low sides to allow air to circulate.

Setting Convection Bake

To set the oven for convection bake and temperature to 375°F:

1. Arrange interior oven racks.
2. Turn the oven mode selector to **CONV BAKE**.
3. Turn the oven temperature selector to **375°F**.
4. Once the oven reaches the set temperature the oven will sound a chime indicating the food items can be placed in the oven.
5. When finished baking, be sure to return both the temperature selector knob and the oven mode knob to the OFF positions.

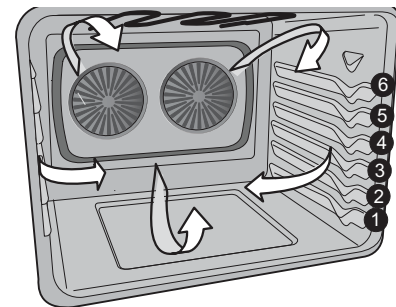

Figure 11: Convection air flow

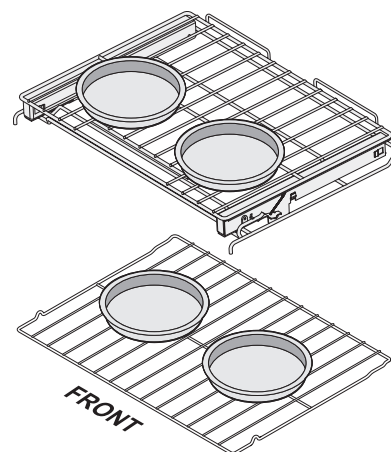

Figure 12: Pan spacing suggestion

SETTING OVEN CONTROLS

Setting Convection Convert

Convection convert automatically converts a standard baking recipe for convection baking. Convection convert may only be used with convection bake.

Important: This feature must be set before selecting the oven mode and oven temperature by using the user preference setting in the oven display.

Because convection baking generally cooks food faster than normal baking, food items should be checked for doneness before the suggested normal recipe cook times.

To set convection convert:

1. The oven temperature selector must be in the **OFF** position.
2. Turn the oven mode selector to **CONV BAKE**.
3. Press and hold both the oven **light** key and the **clock** key for about 3 seconds until **Aut°** (automatic convection convert) appears in the display.

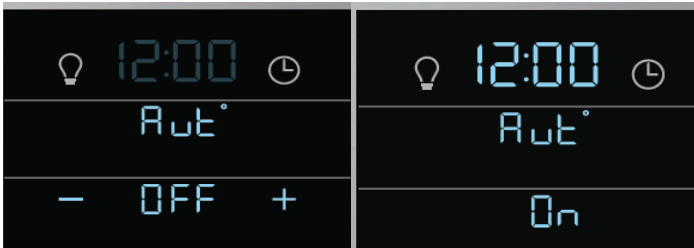

Figure 13: Convection convert off (L) and on (R)

4. Press either the **-** or **+** key until **On** appears.
5. Turn the oven mode selector to the **OFF** position. The oven will accept the convection convert setting with an acceptance chime and the control will return to display the time of day. The convection bake function will now automatically convert normal baking temperatures for convection baking.

To change back to regular convection baking:

Repeat the same steps in this process and press the **+** or **-** key until **OFF** appears.

Once the control accepts the change with a chime, turn the oven mode selector to **OFF**.

Setting Convection Roast

Convection roast is best for cooking tender cuts of beef, lamb, pork, and poultry. Use this mode when cooking speed is desired. Convection roasting gently browns the exterior and seals in the juices. Convection roasting uses the bake element, convection element, broil element, and fan to circulate the heat evenly and continuously within the oven.

Convection roasting tips:

- Use a broiler pan and grid, as well as a roasting rack (available by mail order). The broiler pan will catch grease drippings, and the grid will help prevent spatters. The roasting rack will hold the meat. Make sure the roasting rack is securely seated on the grid in the broiler pan. Do not use the broiler pan without the grid or cover the grid with aluminum foil.
- Pull the rack out to the stop position before removing food. Position food (fat side up) on the roasting rack.
- Do not open the oven door often. Doing so will reduce the temperature in the oven and may increase the cooking time necessary for best results.
- It is not recommended to roast chicken on a roasting rack. Use a deep pan and place on rack position 1 (offset rack).
- Preheating the oven for convection roasting is not necessary.

To set oven for convection roasting:

1. Place meat on roasting rack and place in oven.
2. Turn oven mode selector to **CONV ROAST**.
3. Turn oven temperature selector to desired roasting temperature.
4. Once the control accepts the setting, the convection fan turns on and the oven will heat to the set temperature.
5. To cancel convection roast at any time, turn both the temperature control and the oven mode control to the **OFF** position.

SETTING OVEN CONTROLS

Table 1: Convection roasting temperature and time recommendations

Meat		Weight	Oven Temp	Internal Temp	Minutes per lb.
Beef	Standing rib roast*	4 to 6 lb.	350°F (177°C)	*160°F (71°C)	25-30
	Rib eye roast*	4 to 6 lb.	350°F (177°C)	*160°F (71°C)	25-30
	Tenderloin roast	2 to 3 lb.	400°F (204°C)	*160°F (71°C)	15-25
Poultry	Turkey whole**	12 to 16 lb.	325°F (163°C)	180°F (82°C)	8-10
	Turkey whole**	16 to 20 lb.	325°F (163°C)	180°F (82°C)	10-15
	Turkey whole**	20 to 24 lb.	325°F (163°C)	180°F (82°C)	12-16
	Chicken	3 to 4 lb.	350°F-375°F (177°C-191°C)	180°F (82°C)	12-16
Pork	Ham roast, fresh	4 to 6 lb.	325°F (163°C)	160°F (71°C)	30-40
	Shoulder blade roast	4 to 6 lb.	325°F (163°C)	160°F (71°C)	20-30
	Loin	3 to 4 lb.	325°F (163°C)	160°F (71°C)	20-25
	Pre-cooked ham	5 to 7 lb.	325°F (163°C)	160°F (71°C)	30-40

* The U.S. Department of Agriculture states, "Rare fresh beef is popular, but you should know that cooking it to only 140°F (60°C) means some food poisoning organisms may survive." (Source: Safe Food Book, Your Kitchen Guide, USDA Rev. June 1985.) The lowest temperature recommended by the USDA is 145°F (63°C) for medium rare fresh beef. For well done 170°F (77°C)

** Stuffed turkey requires additional roasting time. Shield legs and breast with foil to prevent over browning and drying of the skin.

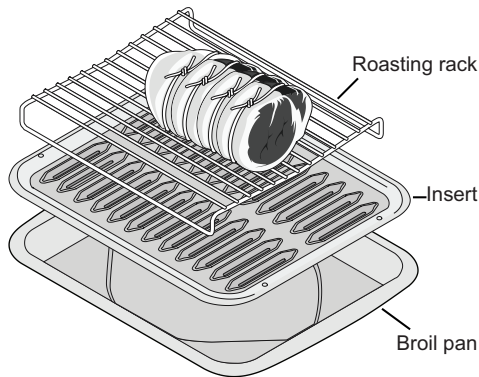

Figure 14: Roast with broil pan and insert and roasting rack

CAUTION

Do not use the broiler pan without the insert. A roasting rack (some models) can be used when convection roasting. Do not cover the broil pan or insert with aluminum foil; the exposed grease could ignite.

WARNING

To prevent food from contacting the broil element and to prevent grease splattering, do not use the roasting rack when broiling.

Important: When roasting chicken use the offset rack in the lowest position for best results.

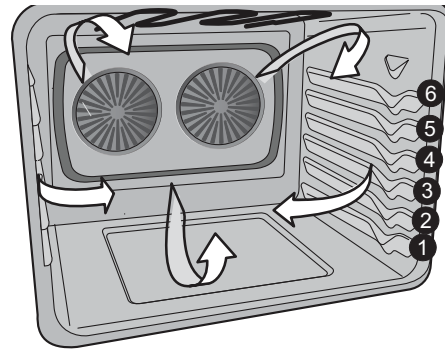

Figure 15: Convection roast air circulation and rack positions

SETTING OVEN CONTROLS

Using the Broil Feature

Use the broil feature to cook meats requiring direct exposure to radiant heat for optimum browning results. Broiling will produce some smoke. If smoke is excessive, place the food further away from the broil element. Always watch food carefully to prevent burning. Always arrange oven racks when the oven is cool. The door must be closed for broil to operate. If the door is left open the display will show "d-O". Close the door for the function to resume. When broiling, always pull the oven rack out to the stop position before turning or removing food.

CAUTION

Always use pot holders or oven mitts when working with a hot oven. When broiling, the oven interior, oven racks and cooktop will become hot enough to cause burns. Do not use the broiler pan without the insert. The insert is slotted and allows the grease to drain away from the meat and the high heat of the broiler into the broiler pan. Do not cover the broil pan or insert with aluminum foil; the exposed grease could ignite.

WARNING

If an oven fire occurs, close the oven door. If the fire continues, throw baking soda on the fire or use a fire extinguisher. Do not put water or flour on the fire. Flour can be explosive; water can cause a grease fire to spread possibly causing personal injury. To prevent grease splattering, use the broil pan and insert when broiling.

To set broil:

1. Arrange oven racks while oven is cool. Turn the mode selector knob to **BROIL**. The indicator light will flash.
2. Turn the temperature selector knob to **BROIL**. The indicator light will turn on and remain lit. For optimum browning results, preheat oven for 2 minutes before adding food.
3. Place the broiler pan on the rack. Be sure to center the broiler pan directly under the broiler element.
4. Broil with the oven door closed. Always pull the oven rack out to the stop position before turning or removing food.
5. Turn the temperature and the selector knobs to **OFF** when broiling is complete or to cancel broil.

Note: If a broiler pan and insert are not supplied with this appliance, they may be purchased from frigidaire.com.

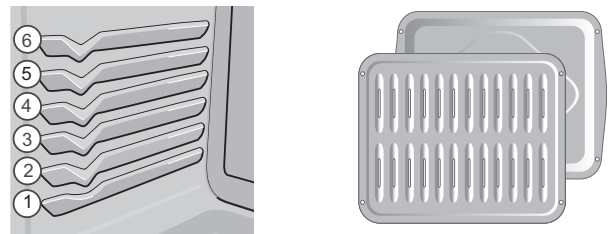

Figure 16: Rack positions (L) Broil pan and insert (R)

Table 2: Recommended Broiling Times

Food	Rack Position	Temperature	Cook time (minutes)		Internal Temperature	Doneness
			1st side	2nd side		
Steak 1" thick	5th or 6th*	550F (288°C)	5	4	145°F (63°C)	Medium*
Steak 1" thick	5th or 6th*	550F (288°C)	8	7	160°F (71°C)	Medium-Well
Steak 1" thick	5th or 6th*	550F (288°C)	8	7	170°F (77°C)	Well
Pork Chops 3/4" thick	5th	550F (288°C)	8	6	170°F (77°C)	Well
Chicken bone-in	4th	550F (288°C)	20	10	170°F (77°C)	Well
Chicken boneless	4th	550F (288°C)	8	6	170°F (77°C)	Well
Fish	4th	550F (288°C)	13	n/a	170°F (77°C)	Well
Shrimp	4th	550F (288°C)	5	n/a	170°F (77°C)	Well
Hamburger 1" thick	6th*	550F (288°C)	5	4	135°F (57°C)	Rare**
Hamburger 1" thick	6th*	550F (288°C)	9	7	145°F (63°C)	Medium
Hamburger 1" thick	6th*	550F (288°C)	10	8	170°F (77°C)	Well

Depending on the type, the thickness, and the desired doneness of meat, it might be necessary to increase or decrease suggested broiling times or adjust the broiling pan to different rack positions. *Use offset rack in top position. The U.S. Department of Agriculture states, "**Rare fresh beef is popular, but you should know that cooking it to only 140°F (60°C) means some food poisoning organisms may survive." (Source: Safe Food Book, Your Kitchen Guide, USDA Rev. June 1985.) The lowest temperature recommended by the USDA is 145°F (63°C) for medium rare fresh beef. For well done 170°F (77°C). All cook times shown are after 2 minutes of preheating.

SETTING OVEN CONTROLS

Meat Probe

Use the probe feature for best results when cooking foods such as roasts, hams or poultry, using a probe to check internal temperature is the safest method to ensure properly cooked food. Before using the meat probe read the important information listed here:

→ IMPORTANT

- The probe feature must be set before setting the cooking mode and oven temperature.
- If no cooking mode is selected within 30 seconds of setting the target temperature, the oven mode indicator light will stop blinking. The display will continue to show the meat probe settings until an allowable cooking mode is selected.
- If a timer is running it must be canceled before the probe temperature can be set.
- If the meat probe is unplugged during a cooking function (or plugged in during BROIL) the oven will turn off.
- When the meat probe is set correctly, the control will signal an alert when the internal food temperature reaches the set temperature.
- When active, the internal food temperature is visible in the display during the cooking process. This eliminates any guesswork or the need to open the oven door to check the thermometer.

Important: If the meat probe is plugged in while the oven is in a function that allows for the meat probe, the control will sound an alert (triple beep) indicating that the meat probe cannot be set until the user does the following:

1. Cancel the active **oven mode**.
2. The display will show the meat probe icon and temperature **000°**.
3. Set the desired **meat probe temperature**.
4. Set the desired **oven mode**.

Proper placement of probe in food.

- Insert the probe so that the probe tip rests inside the center of the thickest part of meat or food (Figure 17). For best results, do not allow the probe to contact bone, fat, gristle, or the cookware.
- For bone-in ham or lamb, insert the probe into the center of lowest large muscle or joint.
- For meatloaf or casseroles, insert the probe into center of food.
- When cooking fish, insert meat probe just above the gill.
- For whole poultry or turkey, fully insert the probe into the thickest part of the breast.

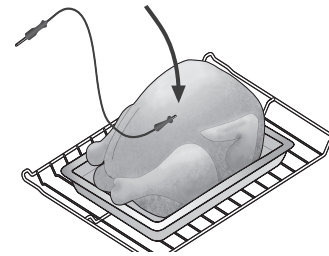
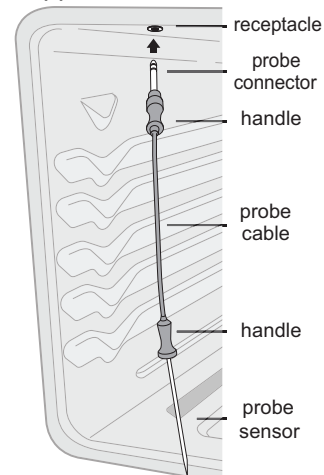

Figure 17: Placing probe in poultry

To set probe:

1. Insert the probe into the food. Place prepared food on the desired oven rack position and slide into the oven.
2. Plug the connector end of the probe into the probe receptacle while the oven is still cool. The receptacle is located on the upper left front oven cavity wall.



SETTING OVEN CONTROLS

Meat Probe (cont'd)

- When the probe is inserted, an acceptance tone will sound, the probe icon appears in the display (See Figure 18). Close the oven door.

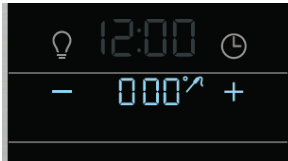

Figure 18: Probe inserted and ready to set temperature

- Press the **+** key to set the desired probe temperature between 140°F and 210°F. If no selection is made within 10 seconds, the control will automatically set the default temperature of 170°F and the display will sound an acceptance chime.

Note: The probe must be fully set before setting the oven mode and temperature mode.

- Set the oven mode to **NO PREHEAT, BAKE, CONV BAKE, or CONV ROAST**.
- Set the **oven temp** control to the desired cooking temperature. The oven will begin heating.
- During the cooking process, an up arrow **↑** and the current meat probe temperature will appear in the display until the meat probe target temperature is reached.
- When 75% of the target temperature is reached, the control will chime and a **CHECK FOOD** reminder will appear in the display. **CHECK FOOD** will remain in the display and continue to chime every 60 seconds for five minutes or until the oven door is open.
- Once the target temperature of the food is reached, the control will chime to signal the end of cooking. At this time the **↑** will turn off and the display will show the **FOOD READY** and **OVEN WARM** messages.

WARNING

Food Poisoning Hazard. Do not let food sit for more than one hour before or after cooking. Doing so can result in food poisoning or sickness.

Trailing Keep Warm with Meat Probe

When the meat probe reaches the target temperature, the oven will automatically switch to keep warm (170°F) and remain on for up to 3 hours before turning off automatically. The display will continue to show the meat probe temperature until either **keep warm** is canceled or by disconnecting the meat probe from the receptacle. Once turned off, the probe icon and temperature will fade from the display.

Important: If the meat probe temperature should exceed the maximum allowable temperature, the oven control will beep and **HOT** will appear in the display for 40 seconds to notify that the probe temperature is too high.

Setting Keep Warm

Keep Warm maintains a temperature of 170°F (77°C) for keeping oven baked foods at serving temperature until canceled. The feature may be used with **BAKE, CONV BAKE, or CONV ROAST**.

Keep warm tips:

- Always start with hot food. Do not use the keep warm feature to heat cold food.
- Food in heat-safe glass and glass ceramic containers may need higher temperature settings compared to food in regular containers. Avoid repeated openings of the oven, it will allow hot air to escape and the food to cool.
- Aluminum foil may be used to cover food to increase moisture content.

To set keep warm:

- Arrange interior oven racks and place food in oven.
- Turn the oven mode selector to **BAKE, CONV BAKE, or CONV ROAST**.
- Set the oven temperature selector to **KEEP WARM**.
- The indicator light will blink and then an acceptance chime will sound.
- The preheat indicator light will turn on and stay on until the oven reaches the keep warm temperature of 170°F.
- When finished using keep warm, be sure to turn both the oven mode selector and the oven temperature selector to **OFF**.

SETTING OVEN CONTROLS

Setting the Sabbath Feature



This appliance provides special settings for use when observing the Jewish Sabbath/Holidays. For further assistance, guidelines for proper usage, and a complete list of models with the Sabbath feature, please visit the web at www.star-k.org.

Sabbath mode disables all audible tones or visual display changes on the oven control. The oven light will turn off and remain off until the Sabbath mode is canceled. The Sabbath feature may only be used with the bake function and can be set for both ovens if desired. Once the oven is set using bake with the Sabbath feature active, the oven will remain on until canceled. .

→ IMPORTANT

- If both ovens are set for Sabbath mode, canceling one oven will not stop the bake function in the other oven.
- If Sabbath mode is activated while one oven is in Bake and other is off, the idle oven will remain inactive. Both ovens must be set to Bake before activating the Sabbath mode if desired.
- Only the Bake function is allowed in an oven. If a non-Bake function is active in one oven and Sabbath is requested, the control will generate the Invalid Key Tone (triple beep) and ignore the request.

To set the oven for baking and activate the Sabbath feature:

1. Be sure the clock is set to the correct time of day. Place food in the oven.
2. Turn the oven mode selector to **BAKE**.
3. Turn the oven temperature selector to the desired bake temperature.
4. An acceptance chime will sound, the oven will start heating and the LED lights will stop blinking and remain on.
5. To enter Sabbath mode press and hold the **oven light** key and the **clock** key at the same time for about 3 seconds. The control will sound an acceptance chime and **SAB** will appear in the display below the time of day.

Figure 19: Oven display showing Sabbath mode

Note: The control will allow any sounds associated with alarms. The oven temperature may be changed by adjusting the oven temperature selector. The active oven will remain in Sabbath until canceled by the user. The Sabbath feature overrides the factory preset 6 hour energy saving feature. The meat probe feature is not available in Sabbath mode.

To turn off the Sabbath feature:

1. Turning the oven mode selector and the oven temperature selector to the **OFF** position will cancel **BAKE** only in the active oven.
2. To turn off the Sabbath feature press and hold both the **oven light** key and the **clock** key for about 3 seconds.
3. **SAB** will disappear from the display. Be sure both oven selectors are returned to the **OFF** positions

Power failure while using Sabbath feature:

Should you experience a power failure or interruption, the oven will shut off. When power is returned, **SF** (Sabbath Failure) will be displayed, and the oven will not turn back on automatically. If your food was nearly fully cooked, you may allow the trapped heat in the oven to finish the cooking process. Otherwise, you should remove the food when the power failure occurs because you may only start the oven once during the Sabbath/Jewish holidays.

To turn off the Sabbath Failure (SF) message:

1. Turn the **oven mode selector** and the **oven temperature selector** to the **OFF** position.
2. Press and hold both the **oven light** and **clock** key for at least 3 seconds.
3. **SF** will disappear from the display, and the oven may be used with all normal functions.

! WARNING

Food Poisoning Hazard. Do not let food sit for more than one hour before or after cooking. Doing so can result in food poisoning or sickness.

SETTING OVEN CONTROLS

Adjusting the Oven Temperature

The temperature in the oven is pre-set at the factory. When first using the oven, be sure to follow recipe times and temperatures.

Do not use oven thermometers such as those found in grocery stores to check the temperature settings inside your oven. These oven thermometers may vary as much as 20 to 40 degrees from actual temperatures.

If you think the oven is cooking too hot or too cool for the temperature you select, you can adjust the actual oven temperature to be more or less than what is displayed by accessing the UPO (User Programmable Offset).

Before adjusting, test a recipe by using a temperature setting higher or lower than the recommended temperature. The baking results should help you to decide how much of an adjustment is needed.

Important: Before making a temperature adjustment, make sure both the oven mode and oven temperature control knobs are in the OFF position.

To adjust the oven temperature:

1. When the oven is idle, press and hold both the light icon and the clock icon at the same time for a few seconds until the display sounds an acceptance chime. **AUd** should appear in the display.
2. Press the **+** key in the upper part of the display until **UPO** appears and the default setting of **0°** (or the last offset temperature) is showing.

The image shows a digital display with two parts. The left part shows 'UPO' in large, bold, black characters. The right part shows '18:80°' in a smaller, black font.

Figure 20: UPO shown at default setting

3. Using the **+** or **-** key in the bottom of the display, press until the desired temperature change (offset) is reached. The display will change $\pm 5^\circ$ with each key press to a maximum of **+ 35°** or a minimum of **- 35°F**.

The image shows a digital display showing '18:80°' in a black font.

Figure 21: UPO shown 10° higher than default

If a lower temperature offset is desired, press the **-** key in the bottom of the display until the desired lower temperature appears.

The image shows a digital display showing '18:80°' in a black font.

Figure 22: UPO shown 10° lower than default

4. Release the key and the control will accept the change.
5. To return the display to normal, press and hold both the oven **light** icon and the **clock** icon at the same time until an acceptance chime sounds. The display will return to show the time of day.

NOTE

Changing the UPO will not affect the broil or self clean temperatures.

Restoring Factory Control Settings

Your appliance was set with standard oven control settings. Over time these may have been changed. Restoring the control to factory (default) settings will affect the following:

- Continuous bake or 6 hour energy saving
- Silent or audible control
- Oven temperature adjustments

To restore oven control to default settings:

1. When the oven is idle, press and hold both the light icon and the clock icon at the same time for a few seconds until the display sounds an acceptance chime.
2. Press the **+** key in the upper part of the display until **rSt** appears and **yes** or **no** appear in the lower part of the display.

The image shows a digital display showing '18:58' in a black font.

3. Press the **+** or **-** key to toggle between **yes** (to reset to default) or **no** (to leave current settings as they are).
4. When the desired setting appears, the control will accept the change after a few seconds with a beep and return to the clock mode.

SETTING OVEN CONTROLS

Self Cleaning

A self cleaning oven cleans itself with temperatures well above normal cooking temperatures which eliminate soils completely or reduces them to a fine powdered ash you can wipe away with a damp cloth.

While the oven is in operation, the oven heats to temperature much higher than those used in normal cooking. Sounds of metal expansion and contraction are normal. Odor is also normal because the food soil is being removed. Smoke may appear through the oven vent.

→ IMPORTANT

Adhere to the following self clean precautions:

- Do not use oven cleaners or oven protective coatings in or around any part of the oven interior.
- Do not clean the oven door gasket (Figure 23). The woven material of the oven door gasket is essential for a good seal. Care should be taken not to rub, damage, or remove the gasket.
- Do not use any cleaning materials on the oven door gasket. Doing so could cause damage.
- Remove the broiler pan and insert, all utensils, and any aluminum foil. These items cannot withstand high cleaning temperatures and will melt.
- Completely remove all oven racks and any accessories. If the oven racks are not removed, they will lose their special coating properties and no longer slide in and out of the oven cavity easily.
- Remove any excessive spills. Any spills on the oven bottom should be wiped up and removed before starting the self cleaning cycle. To clean, use hot, soapy water and a cloth. Large spills can cause heavy smoke or fire when subjected to high temperatures.
- Do not allow food spills with a high sugar or acid content (such as milk, tomatoes, sauerkraut, fruit juices, or pie filling) to remain on the surface as they may leave a dull spot even after cleaning.
- Clean any soil from the oven frame, the door liner outside the oven door gasket, and the small area at the front center of the oven bottom. These areas heat sufficiently to burn soil on. Clean with soap and water. These areas are shown in white (Figure 23).

⚠ CAUTION

During the self cleaning cycle, the outside of the oven can become very hot to the touch.

Do not leave small children unattended near the appliance.

The health of some birds is extremely sensitive to the fumes given off during the self cleaning cycle of any oven. Move birds to another well ventilated room.

Do not force the oven door open. This can damage the automatic door locking system. Use caution when opening the door after the self cleaning cycle is complete. The oven may still be very hot.

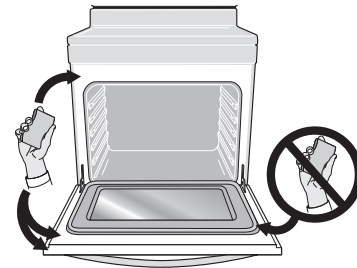

Figure 23: Clean around the oven door gasket

⚠ CAUTION

To avoid possible burns, use care when opening the oven door after the self-cleaning cycle. Stand to the side of the oven when opening the door to allow hot air or steam to escape.

Do not line the oven walls, racks, bottom, or any other part of the oven with aluminum foil. Doing so will destroy heat distribution, produce poor baking results, and cause permanent damage to the oven interior (aluminum foil will melt to the interior surface of the oven).

SETTING OVEN CONTROLS

Setting Self Clean

If you are planning to use the oven directly after a self clean cycle, remember to allow time for the oven to cool down and the oven door to unlock. This normally takes about one hour. A 3 hour self clean cycle will actually take about 4 hours to complete.

It is recommended to use a 2 hour self clean cycle for light soils, a 3 hour cycle for average soils, and a 4 hour cycle for heavy soils.

To set the controls for a 3 hour self clean cycle and shut off automatically:

1. Turn both the oven mode and oven temperature selectors to **CLEAN**. The display will show a 3 hour time (normal clean) and the **-** and **+** keys.

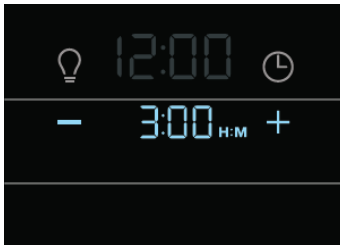

Figure 24: Oven set for 3 hour clean

2. If a 3 hour clean is desired, the control will accept the time within 3 seconds. However, the user may select a 2 or 4 hour clean by using the **-** or **+** keys to change to the desired clean time and then allow the control to accept the change.

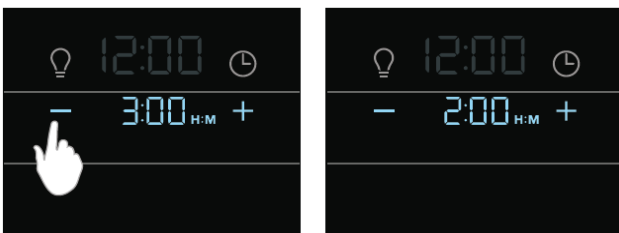

Figure 25: Setting 2 hour clean

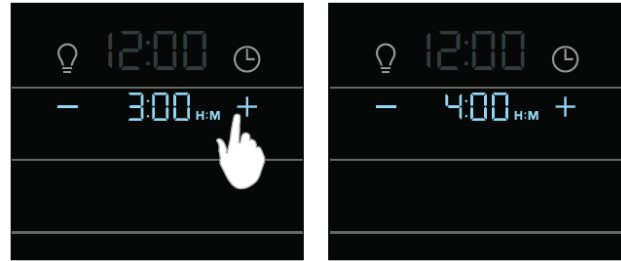

Figure 26: Setting 4 hour clean

Once the control accepts the clean time the display will flash a reminder for the user to **REMOVE RACKS**. The

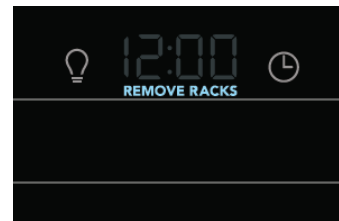

Figure 27: Display prompting user to remove racks

REMOVE RACKS notification will flash for a few seconds prompting the user to remove all oven racks. If the oven door is opened as this time the display will show **CLO** to indicate that the door must be closed before the clean cycle can begin. If the door remains open for more than 3 minutes, the clean function will be canceled.

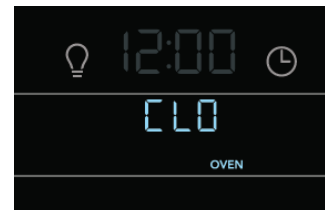

Figure 28: Message of open door that must be closed before oven can begin the clean cycle

When the oven is set to run the clean cycle, the motor door lock will begin locking the oven door. Do not attempt to open the oven door while the lock motor is running or when any locking indicators or displays are showing; this can damage the door locking system. The oven door is completely locked in about 15 seconds.

SETTING OVEN CONTROLS

- Once the door is closed the time of day will be visible along with the selected clean time and the door lock icon will be blinking in the display. Do not force the oven door open when the self clean is active. This can damage the automatic door locking system.

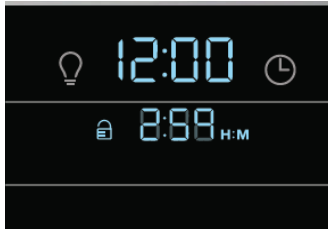

Figure 29: Clean cycle in progress

- During the clean cycle the time of day remains in the display and the time remaining in the clean cycle will also be active. (Figure 29)



Figure 30: Hot oven after clean with door still locked

- When the clean cycle ends the oven will be too hot for the door to unlock until the oven cools to a safe temperature. This may take up to an hour. During this time the display will show **Hot** along with the door lock icon.
- Once the oven temperature reaches a safe level, **CLn** will appear in the display and the lock icon will blink to signal the end of the clean cycle with a chime. Do not force the oven door open when the lock icon is showing in the display; this can damage the automatic door locking system.
- Move both the oven mode and temperature mode knob to the **OFF** position to clear the display.

Caution: To avoid possible burns, use care when opening the oven door after a self clean cycle. Stand to the side to allow any steam and heat to escape. The internal oven temperature will still be hot enough to cause burns even though the bake and broil elements appear to have cooled.



Figure 31: Clean lock icon blinks as door unlocks

Note: Once the clean cycle ends the oven will not be available for another clean for 4 hours.

To cancel a self clean before it ends:

Turn both the oven selector knob and the oven temperature knob to the **OFF** position.

CARE AND CLEANING

Cleaning Various Parts of Your Oven

Before cleaning any part of the oven, be sure all controls are turned off and the oven is cool. Remove spills and any heavy soiling as soon as possible. Regular cleaning will reduce the number of major cleaning later.

Surface Type	Recommendation
Aluminum and Vinyl trim Painted body parts Painted decorative trims Plastic	Use hot, soapy water and dry with a clean cloth. Use a soft cloth and clean with mild dish detergent and water or a 50/50 solution of vinegar and water. Follow by rinsing the area with clean water; dry and polish with a soft cloth. Glass cleaners may be used if sprayed on a soft cloth first. Do not spray liquids directly on the oven control and display area. Do not use large amounts of water on the control panel. Excess water on the control area may cause damage to the appliance. Do not use other liquid cleaners, abrasive cleaners, scouring pads, or paper towels. They will damage the finish.
Control Pad Decorative trim (some models)	Use a soft cloth and clean with mild dish detergent and water or a 50/50 solution of vinegar and water. Follow by rinsing the area with clean water; dry and polish with a soft cloth. Glass cleaners may be used if sprayed on a soft cloth first. Do not spray liquids directly on the oven control and display area. Do not use large amounts of water on the control panel. Excess water on the control area may cause damage to the appliance. Do not use other liquid cleaners, abrasive cleaners, scouring pads, or paper towels. They will damage the finish.
Stainless steel (some models)	Only use cleaners and polishes specifically manufactured for cleaning stainless steel. Always rub in direction of metal grain to avoid damaging. Do not use cleaners with high concentrations of chlorides or chlorine. Do not use harsh scrubbing cleaners. Polish with a lint-free cloth. Be sure to wipe excess cleaner/polish off from the metal surface as bluish stains may occur during future oven heating that cannot be removed. Clean heavier soils with hot, soapy water and a cloth or sponge. Use clean water to rinse; use a cloth to dry
Smudge-Proof™ Stainless Steel (some models)	Clean the stainless with warm soapy water using a clean sponge or cloth. Rinse with clean water and dry with a soft clean cloth. Do not use store bought cleaners like stainless steel cleaners or any other types of cleaners containing any abrasive, chlorides, chlorine, or ammonia. Use mild dish soap and water or a 50/50 solution of water and vinegar.
Porcelain enamel broiler pan and insert (available by mail order) Door liner and body parts	Gentle scouring with a soapy scouring pad will remove most spots. Rinse with a 1:1 solution of clear water and ammonia. If necessary, cover difficult spots with an ammonia soaked paper towel for 30 to 40 minutes. Rinse with clean water and a damp cloth, then scrub with a soap-filled scouring pad. Rinse and wipe dry with a clean cloth. Remove all cleaners or the porcelain may become damaged during future heating.
Oven interior	Remove oven racks from the oven cavity before cleaning the oven interior. Use a mild, abrasive cleaner following manufacturer's instructions. Rinse with clean water and dry.
Oven racks	Oven racks must be removed before a self clean. Clean by using a mild, abrasive cleaner following manufacturer's instructions. Rinse with clean water and dry.
Glide Rack	To maintain the glide rack see Caring for your glide rack on page 28.
Oven door	Use soap and water to thoroughly clean the top, sides, and front of the oven door. Rinse well. Only use a glass cleaner on the outside glass of the door. Do not immerse the door in water. Do not spray or allow water or the glass cleaner to enter the door vents. Do not use oven cleaners, powders, or any harsh abrasive cleaning materials on the outside of the oven door. Do not clean the oven door gasket which is essential for a good seal. Do not rub, damage, or remove this gasket.

CARE AND CLEANING

General Cleaning

Refer to the table at the beginning of this chapter for more information about cleaning specific parts of the oven.

CAUTION

Before manually cleaning any part of the oven, be sure all controls are turned off and the oven is cool. The oven may be hot and can cause burns.

Remove all racks and accessories from the oven before cleaning.

Ammonia must be rinsed before operating the oven. Provide adequate ventilation.

Follow these cleaning precautions:

- Allow the oven to cool before cleaning.
- Wear rubber gloves when cleaning the appliance manually.

Remove soils using hot, soapy water. Do not allow food spills with a high sugar or acid content (such as milk, tomatoes, sauerkraut, fruit juices or pie filling) to remain on the surface as they may cause a dull spot even after cleaning. Remove spillovers and heavy soiling as soon as possible. Regular cleaning will reduce the effort required for major cleaning later.

Cleaning Porcelain Enamel Oven

The oven interior is porcelain on steel, it is safe to clean using oven cleaners.

To remove heavy soil:

1. Allow a dish of ammonia to sit in the oven overnight or for several hours with the oven door closed. Clean softened dirt spots using hot, soapy water. Rinse well with water and a clean cloth.
2. If soil remains, use a nonabrasive scouring pad or a nonabrasive cleaner. If necessary, use an oven cleaner following manufacturer's instructions. Do not mix ammonia with other cleaners.
3. Clean any soil from the oven frame, the door liner outside the oven door gasket and the small area at the front center of the oven bottom. Clean with hot, soapy water. Rinse well using clean water and a cloth.

Boiler Pan Cleaning Tips

To prevent grease from baking on, remove the broiler pan from the oven as soon as cooking is completed. Use oven mitts because the broiler pan is extremely hot. Pour off grease. Soak the pan in hot, soapy water.

Clean the broiler pan as soon as possible after each use. If necessary, use soap-filled steel wool pads. Heavy scouring may scratch the grid.

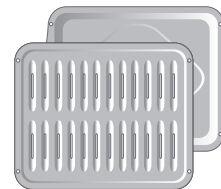

Figure 32: Broiler pan with insert

CARE AND CLEANING

Aluminum Foil, Aluminum Utensils, and Oven Liners

WARNING

Never cover any slots, holes, or passages in the oven bottom or cover an entire oven rack with materials such as aluminum foil. Doing so blocks air flow through the oven and may cause carbon monoxide poisoning. Aluminum foil linings may trap heat, causing a fire hazard.

- Protective liners—Do not use aluminum foil to line the oven bottom. The high heat of the oven can melt these materials to the oven cavity and ruin the oven. These types of materials can also reduce the effectiveness of the air circulation in the oven and produce poor baking results. Only use aluminum foil as recommended in this manual. Improper installation of these liners may result in risk of electric shock or fire.
- Aluminum utensils - The melting point of aluminum is much lower than that of other metals. Care must be taken when aluminum pots or pans are used.
- Oven racks - Do not use aluminum foil to cover the oven racks. Using a liner in the oven restricts the heat and air flow needed to obtain the best possible cooking results for any oven.

Adhere to the following precautions when using spray oven cleaners:

- Do not spray cleaner on the electrical controls or switches because it could cause a short circuit and result in sparking or fire.
- Do not spray any cleaner on the oven door trim or gasket, broiler drawer glides, handles or any exterior surfaces of the oven, plastic or painted surfaces. The cleaner can damage these surfaces.
- Do not allow a film from the cleaner to build up on the temperature sensing bulb; it could cause the oven to heat improperly. The bulb is located in the rear of the oven. Carefully wipe the bulb clean after each oven cleaning, being careful not to move the bulb. A change in its position could affect how the oven bakes. Avoid bending the bulb and capillary tube.

Replacing the Oven Light

CAUTION

Be sure the oven is unplugged and all parts are cool before replacing the oven light.

The interior oven light is located at the rear of the oven cavity and is covered by a glass shield. The glass shield must be in place whenever the oven is in use (Figure 33).

To replace the oven interior light bulb:

1. Turn electrical power off at the main source or unplug the appliance.
2. Remove interior oven light shield by turning a quarter turn counter-clockwise.
3. Replace bulb with a new T-4 type Halogen 25 watt appliance bulb.

NOTE

Wear a cotton glove or use a paper towel when installing a new bulb. Do not touch the new bulb with your fingers when replacing. This will shorten the life of the bulb.

4. Replace glass oven light shield by rotating clockwise.
5. Turn power back on again at the main source (or plug the appliance back in).
6. Be sure to reset the time of day on the clock

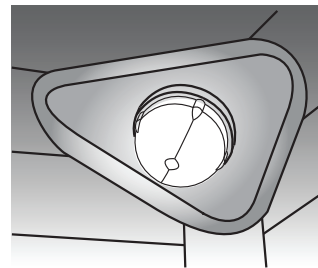

Figure 33: Wall oven Halogen light

CARE AND CLEANING

Removing and Replacing the Oven Door

→ IMPORTANT

Special door care instructions - The door is heavy. For safe, temporary storage, lay the door flat with the inside of the door facing down.

Most oven doors contain glass that can break. Do not close the oven door until all the oven racks are positioned correctly in the cavity. Do not hit the glass with bakeware or any other objects. Scratching, hitting, jarring, or stressing the glass may weaken its structure, causing an increased risk of breakage at a later time.

To remove the oven door:

1. Open oven door completely, horizontal with floor.
2. Pull up the lock located on each hinge support toward front of the oven until the lock stops. You may have to apply a little upward pressure on the lock to pull it up (Figure 35 and Figure 36).
3. Grasp the door by the sides, and close the door until the door frame makes contact with the unlocked hinges.
4. Pull the bottom of the door toward you while rotating the top of the door toward the appliance to completely disengage the hinge levers (Figure 37).

To Replace Oven Door:

1. Firmly grasp both sides of oven door along the door sides. Do not use the oven door handle (Figure 37).
2. Hold the oven door at the same angle as the removal position. Carefully insert the hinge levers into the oven frame until you feel the hinge levers are seated into the hinge notches. The hinge arms must be fully seated into the hinge notches before the oven door can be fully opened. (Figure 37).
3. Fully open the oven door, horizontal with floor (Figure 34).
4. Push the door hinge locks up toward and into the oven frame on both left and right oven door hinges to the locked position (Figure 35).
5. Close the oven door.

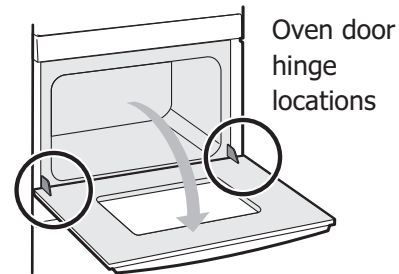

Figure 34: Door hinge location

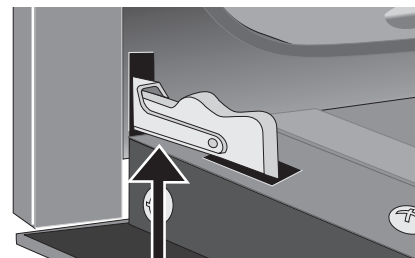

Figure 35: Door hinge locked

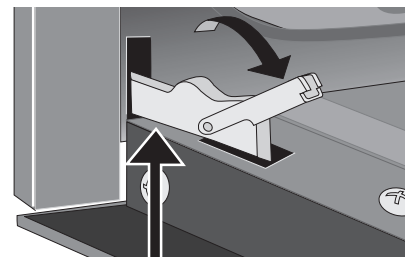

Figure 36: Unlocking door hinge

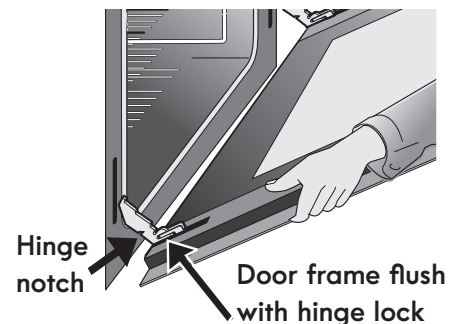

Figure 37: Remove door position

CARE AND CLEANING

Caring for your glide racks

CAUTION

Handle oven racks only when they are cool. After cooking racks will be very hot and can cause burns.

Important: Remove all oven racks before starting a self clean cycle. If oven racks are left inside the oven during a cleaning cycle, the slide ability of the glide rack may be damaged and the racks will lose their finish.

- Anytime the gliding is rough, the glide rack tracks should be treated with graphite lubrication.
- Do not use cooking oil, cooking spray, or other oil-based lubrication products on the glide rack extension tracks. Use only the graphite lubrication in this area. To order graphite lubrication, contact your installer, servicer or dealer.

To lubricate the glide rack:

1. Remove the rack from the oven and place the rack on a large flat surface covered with newspaper or scrap cloth. Fully extend the rack.
2. Wipe away debris and crumbs from the glide track using a cloth or sponge.

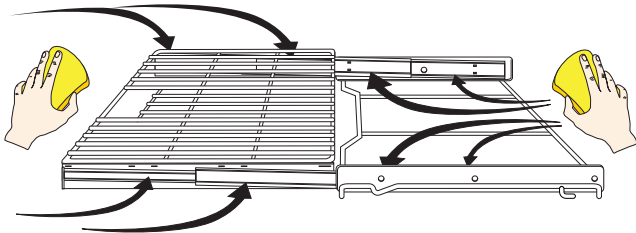

3. Shake graphite lubrication very well before applying. Place four drops of graphite lubrication along the tracks (see area circled on figure below). Repeat on both sides of the glide rack.

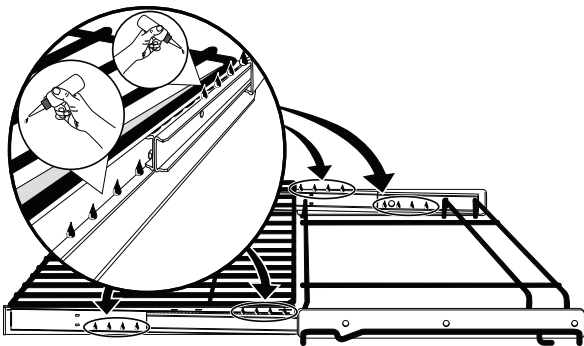

4. Extend and return the glide rack several times along the tracks to distribute the lubrication.

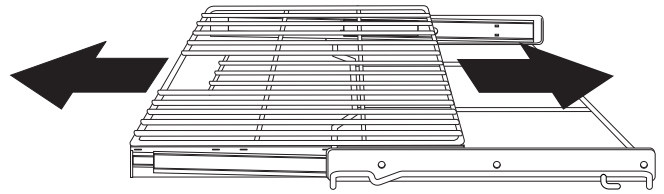

5. Turn glide rack over. Shake graphite lubrication very well before applying. Place four drops of graphite lubrication along the tracks. Repeat on both sides of the glide rack.

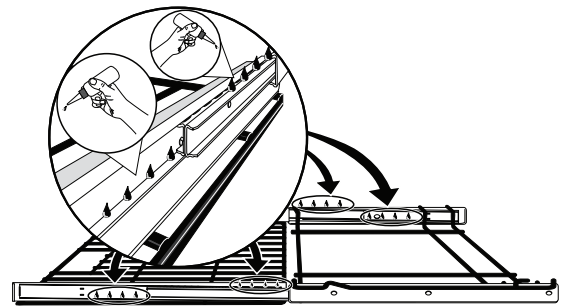

6. Extend and return the glide rack several times along the tracks to distribute the lubrication.

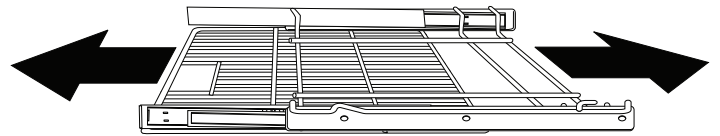

7. Apply a thin layer of cooking oil to the outer frame of the glide rack as shown below. Keeping the frame sides lightly lubricated allows the entire rack to slide easily when changing rack positions.

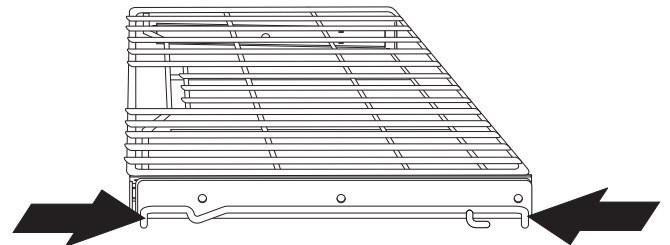

8. Replace rack in oven right side up.

BEFORE YOU CALL





Solutions to Common Baking Problems

For best cooking results, fully preheat the oven before baking cookies, breads, cakes, pies or pastries, etc.

There is no need to preheat the oven for roasting meat or baking casseroles.

The cooking times and temperatures needed to bake a product may vary slightly from your previously owned appliance.

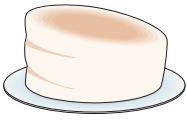
Baking Problems and Solutions Chart

Baking Problems	Causes	Corrections
Cookies and biscuits burn on the bottom. 	<ul style="list-style-type: none"> • Cookies and biscuits put into oven before the preheating time is completed. • Oven rack is overcrowded. • Dark pans absorb heat too fast. 	<ul style="list-style-type: none"> • Allow oven to preheat to desired temperature before placing food in oven, • Choose pan sizes that will permit 2 to 4 inches (5.1 to 10.2 cm) space on all sides when placed in the oven. • Use a medium weight baking sheet.
Cakes too dark on top or bottom. 	<ul style="list-style-type: none"> • Cakes put in oven before preheating time is completed. • Rack position too high or too low. • Oven too hot. 	<ul style="list-style-type: none"> • Allow oven to preheat to the selected temperature before placing food in the oven. • Use proper rack position for baking needs. • Set oven temperature 25°F (13°C) lower than recommended.
Cakes not done in center. 	<ul style="list-style-type: none"> • Oven too hot. • Incorrect pan size. • Pan not centered in oven. 	<ul style="list-style-type: none"> • Set oven temperature 25°F (13°C) lower than recommended. • Use pan size suggested in recipe. • Use proper rack position and place pan to allow for 2 to 4 inches (5.1 cm to 10.2 cm) space on all sides of pan.
Cakes not level. 	<ul style="list-style-type: none"> • Oven not level. • Pan too close to oven wall or rack overcrowded. • Pan warped. • Oven light left on while baking. 	<ul style="list-style-type: none"> • Place a marked glass measuring cup filled with water on the center of the oven rack. If the water level is uneven, refer to the installation instructions for leveling the oven. • Be sure to allow 2" to 4" (5.1 cm to 10.2 cm) of clearance on all sides of each pan in the oven. • Do not use pans that are dented or warped. • Leave oven light off while baking.
Foods not done when cooking time is over. 	<ul style="list-style-type: none"> • Oven too cool. • Oven overcrowded. • Oven door opened too frequently. 	<ul style="list-style-type: none"> • Set oven temperature 25°F (13°C) higher than suggested and bake for the recommended time. • Be sure to remove all pans from the oven except the ones to be used for baking. • Open oven door only after shortest recommended baking time.

Solutions to Common Problems

Before you call for service, review the following list. It may save you time and expense.

Possible solutions are provided with the problem listed:

Problem	Solution
Oven control panel beeps and displays error codes	<ul style="list-style-type: none"> Oven control has detected a fault or error condition. When this occurs an E or F will show in the display. Turn both oven selectors to the OFF position; Activate a Bake or Broil using both the oven mode and temperature selectors. If the F or E code error repeats, turn off power to appliance, wait 5 minutes and then repower appliance. Set clock with correct time of day. Try Bake or Broil function again. If a fault code appear again, turn both oven selectors to the OFF position to clear the error code and contact your servicer.
Poor baking results	<ul style="list-style-type: none"> Many factors effect baking results. Use proper oven rack position. Center food in the oven and space pans to allow air to circulate. Preheat oven to the set temperature before placing food in the oven. Try adjusting the recipe's recommended temperature or baking time. See "Adjusting the Oven Temperature" on page 21 if you feel the oven is too hot or cold.
No Preheat performs poorly	<ul style="list-style-type: none"> No Preheat not used correctly. This cooking function is intended for convenience, precooked, and other specific foods. See "Setting No Preheat" on page 12 and follow tips for best using this feature.
Appliance is not level	<ul style="list-style-type: none"> Poor installation. Place oven rack in center of oven. Place a level on the oven rack to check if oven has been properly installed. Kitchen cabinet alignment may make oven appear not level. Be sure cabinets are square and have sufficient room for appliance clearance. If cabinets are not square or are built in too tightly, contact builder or installer to make appliance accessible.
Cannot move appliance easily Appliance must be accessible for service	<ul style="list-style-type: none"> Cabinets not square or are built in too tightly. Contact builder or installer to make appliance accessible.
Appliance does not operate	<ul style="list-style-type: none"> Electrical power outage. Check house lights to be sure. Call your local electric company for service outage information. Service wiring is incomplete. Call 1-800-944-9044 for assistance.
Flames inside oven or smoking from oven vent	<ul style="list-style-type: none"> Excessive spills in oven. Grease or food spilled onto oven bottom or oven cavity. Wipe up excessive spills before starting oven. If flames or excessive smoke are present when broiling, see "Using the Broil Feature" on page 17.

BEFORE YOU CALL

Oven does not operate.	<ul style="list-style-type: none">• The time of day is not set. The oven clock must first be set in order to operate the oven. See “Setting the Clock” on page 10.• Be sure oven controls are set properly. See “OVEN DISPLAY FEATURES” beginning on page 9 and review instructions for the desired cooking function in this manual.
Oven smokes excessively when broiling.	<ul style="list-style-type: none">• Incorrect setting. See “Using the Broil Feature” on page 17.• Meat too close to the broil element. Reposition rack to provide proper clearance between the meat and broil element. Remove excess fat from meat. Cut remaining fatty edges to prevent curling, but do not cut into lean.• Grease build up on oven surfaces. Regular cleaning is necessary when broiling frequently. Grease or food splatters will cause excessive smoking.
Oven racks discolored or do not slide easily.	<ul style="list-style-type: none">• Clean by using a mild abrasive cleaner following manufacturer's instructions. Rinse with clean water, dry, and replace in oven.
Glide racks	<ul style="list-style-type: none">• To maintain glide rack see “Caring for your glide racks” on page 29.
Oven light does not work.	<ul style="list-style-type: none">• Be sure the oven light is secure in the socket. See “Replacing the Oven Light” on page 27.
Fan noise occurring after the oven is turned off	<ul style="list-style-type: none">• Some models are equipped with a cooling fan that runs during the cooking process to cool internal electronic components. It is normal for this fan to continue to run for an extended period of time, even when the oven has been turned off.

WARRANTY

Your appliance is covered by a one year limited warranty. For one year from your original date of purchase, Electrolux will pay all costs for repairing or replacing any parts of this appliance that prove to be defective in materials or workmanship when such appliance is installed, used and maintained in accordance with the provided instructions.

Exclusions

This warranty does not cover the following:

1. Products with original serial numbers that have been removed, altered or cannot be readily determined.
2. Product that has been transferred from its original owner to another party or removed outside the USA or Canada.
3. Rust on the interior or exterior of the unit.
4. Products purchased "as-is" are not covered by this warranty.
5. Food loss due to any refrigerator or freezer failures.
6. Products used in a commercial setting.
7. Service calls which do not involve malfunction or defects in materials or workmanship, or for appliances not in ordinary household use or used other than in accordance with the provided instructions.
8. Service calls to correct the installation of your appliance or to instruct you how to use your appliance.
9. Expenses for making the appliance accessible for servicing, such as removal of trim, cupboards, shelves, etc., which are not a part of the appliance when it is shipped from the factory.
10. Service calls to repair or replace appliance light bulbs, air filters, water filters, other consumables, or knobs, handles, or other cosmetic parts.
11. Surcharges including, but not limited to, any after hour, weekend, or holiday service calls, tolls, ferry trip charges, or mileage expense for service calls to remote areas, including the state of Alaska.
12. Damages to the finish of appliance or home incurred during installation, including but not limited to floors, cabinets, walls, etc.
13. Damages caused by: services performed by unauthorized service companies; use of parts other than genuine Electrolux parts or parts obtained from persons other than authorized service companies; or external causes such as abuse, misuse, inadequate power supply, accidents, fires, or acts of God.

DISCLAIMER OF IMPLIED WARRANTIES; LIMITATION OF REMEDIES

CUSTOMER'S SOLE AND EXCLUSIVE REMEDY UNDER THIS LIMITED WARRANTY SHALL BE PRODUCT REPAIR OR REPLACEMENT AS PROVIDED HEREIN. CLAIMS BASED ON IMPLIED WARRANTIES, INCLUDING WARRANTIES OF MERCHANTABILITY OR FITNESS FOR A PARTICULAR PURPOSE, ARE LIMITED TO ONE YEAR OR THE SHORTEST PERIOD ALLOWED BY LAW, BUT NOT LESS THAN ONE YEAR. ELECTROLUX SHALL NOT BE LIABLE FOR CONSEQUENTIAL OR INCIDENTAL DAMAGES SUCH AS PROPERTY DAMAGE AND INCIDENTAL EXPENSES RESULTING FROM ANY BREACH OF THIS WRITTEN LIMITED WARRANTY OR ANY IMPLIED WARRANTY. SOME STATES AND PROVINCES DO NOT ALLOW THE EXCLUSION OR LIMITATION OF INCIDENTAL OR CONSEQUENTIAL DAMAGES, OR LIMITATIONS ON THE DURATION OF IMPLIED WARRANTIES, SO THESE LIMITATIONS OR EXCLUSIONS MAY NOT APPLY TO YOU. THIS WRITTEN WARRANTY GIVES YOU SPECIFIC LEGAL RIGHTS. YOU MAY ALSO HAVE OTHER RIGHTS THAT VARY FROM STATE TO STATE.

If You Need Service

Keep your receipt, delivery slip, or some other appropriate payment record to establish the warranty period should service be required. If service is performed, it is in your best interest to obtain and keep all receipts. Service under this warranty must be obtained by contacting Electrolux at the addresses or phone numbers below.

This warranty only applies in the USA and Canada. In the USA, your appliance is warranted by Electrolux Major Appliances North America, a division of Electrolux Home Products, Inc. In Canada, your appliance is warranted by Electrolux Canada Corp. Electrolux authorizes no person to change or add to any obligations under this warranty. Obligations for service and parts under this warranty must be performed by Electrolux or an authorized service company. Product features or specifications as described or illustrated are subject to change without notice.

USA
1.800.944.9044
Electrolux Home Products, Inc.
10200 David Taylor Drive
Charlotte, NC 28262



Canada
1.800.265.8352
Electrolux Canada Corp.
5855 Terry Fox Way
Mississauga, Ontario, Canada
L5V 3E4