

# THERMADOR PRO GRAND® Range

## Quick Reference Guide

**IMPORTANT:**

This reference guide is not a substitute for the Use & Care Guide. Before using this product, read the appliance Use & Care Guide for important safety messages and additional information regarding the use of your new appliance.

**NOTE:** Not all items discussed will apply to all models.

The use of brand names is intended only to indicate a type of cleaner. This does not constitute an endorsement. The omission of any brand name cleaner does not imply its adequacy or inadequacy. Many products are regional in distribution and can be found in the local markets. It is imperative that all products be used in strict accordance with instructions.

### GETTING TO KNOW YOUR NEW RANGE

1. The ExtraLow® feature cycles on and off to maintain temperatures as low as 100°F. XLO is perfect for simmering delicate sauces or keeping food warm without scorching.

To access, turn the burner knob to XLO, the very lowest setting. The burner will turn on for 7 seconds and then turn off for 53 seconds. When the knob is rotated just beyond the SIM setting, the flame will cycle on for approximately 54 seconds and off for 6 seconds. This cycle repeats itself until the burner is turned to a different setting or off.

2. The 22,000 BTU POWERBOOST® burner is 4,000 BTU greater on its highest setting than any other burner. It offers the convenience to quickly boil water, sear steaks, stir-fry vegetables, etc.

To access, turn the front, right burner knob to XHI. Use of the XLO remains the same as the other XLO Knobs.

3. The pedestal STAR® Burner with QuickClean® Base is designed for easy surface cleaning and superior heat spread for any size pan.

If any one or more burners blow out, the electronic igniter automatically activates to re-light the flame.

4. The cooling blowers activate after the oven reaches 300°F. When the oven is turned off, the blowers remain on until the oven temperature cools below 250°F.
5. During a cook mode, the needle of the temperature gauge will move to the new selected temperature setting if the temperature setting is increased or decreased. As the oven cools down, the temperature gauge will reduce, to reflect the cooling oven temperature.
6. Panel lighting provides function and stylish aesthetics.
7. Electronic oven display(s) includes a Kitchen Timer and a Cook Timer.

The Kitchen Timer functions like a conventional timer that will count down and beep when the desired time has ended. It can be used despite whether the range is in operation and independently of all other functions. It does not affect how the oven operates.

The Cook Timer is intended to mechanically shut the oven off when the desired cooking time is complete. The Cook Timer function is available for all of the primary cooking modes except for Self-Clean mode.

8. Full Access® telescopic gliding oven racks has an integrated easy-grip handle. Each gliding rack can be pulled out and pushed back into the oven with minimal effort.

Always remove the oven racks before self-cleaning the oven. If the gliding racks remain in the oven during Self-Clean, lubricants in the glide mechanisms of each rack will be lost and the finish will discolor.

9. SoftClose® hinges for ultra smooth closing of the oven door(s).

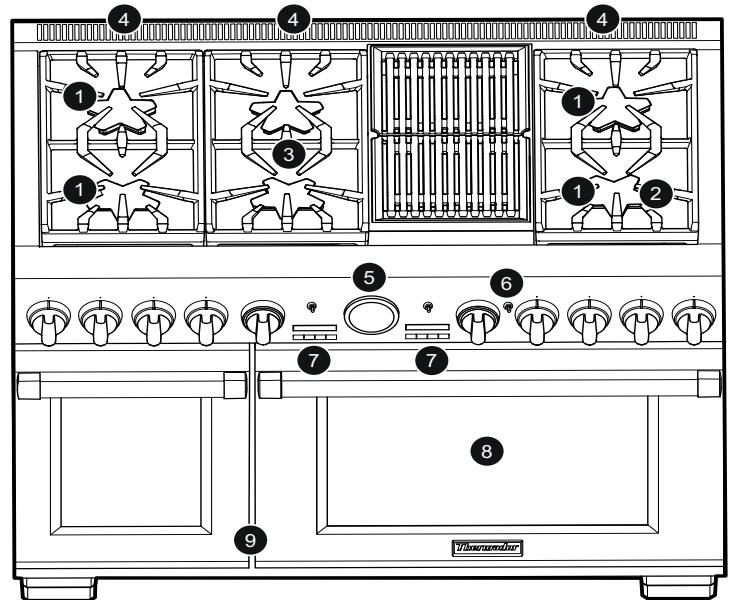

Model shown is a 48" with a large and small oven

## PRO GRAND OVEN MODES AND DESCRIPTION USAGE

MODE	USE
BAKE	Cooks with dry, heated air. Variety of foods, such as cakes, cookies, pastries, quick breads, quiche and casseroles
CONVEC BAKE	Similar to Bake, but air is circulated by a fan at the back of the oven. Best for baked goods such as cakes, cornbread, pies, quick breads, tarts, and yeast breads.
KEEP WARM	Maintains a low temperature in order to keep food hot. Best for baked goods such as cakes, cornbread, pies, quick breads, tarts, and yeast breads.
CONVEC ROAST	Uses lower and more intense heat from upper element than Convection Bake with air circulated by a fan. Tender cuts of meat and poultry. Roasting vegetables. Meats are more juicy and moist than results with Roast mode
ROAST	Uses more intense heat from upper element, more browning of exterior. Best suited for meats, poultry, less tender cuts of meats and roasting vegetables.
CONVEC BROIL	Combines intense heat from upper element with fan circulation. Tender cuts of meat (more than 1"), poultry and fish. Not for browning.
BROIL	Uses intense heat radiated from the upper element. Tender cuts of meat (1" or less), poultry, browning bread & casseroles.
STEAM*	Steams vegetables, fish, and side dishes; extracts juices.
STEAM CONVEC*	Combines steam and convection oven modes. Use for meat, soufflés and baked goods.
PROOF	Proof (raises) yeast dough and sourdough.
SLOW COOK*	Slowly roasts meats so they remain very tender. Place food in oven after PREHEAT.
DEFROST*	Defrosts fruits, vegetables, meats and fish for cooking or serving.
REHEAT*	Gently reheats cooked foods in plated dishes and baked dishes.
TRUE CONVEC*	Operates as a convection oven, with no steam. Place food in oven after PREHEAT. Use for moist cakes, sponge cakes and braised meat.
EASY COOK*	Sets automatic programming.
SELF CLEAN or STEAM CLEAN*	Self cleans the oven.

\*Steam range models only

## RACK LEVELS

Do not handle the rack when it is hot. Make sure the oven rack is in the desired position before preheating the oven.

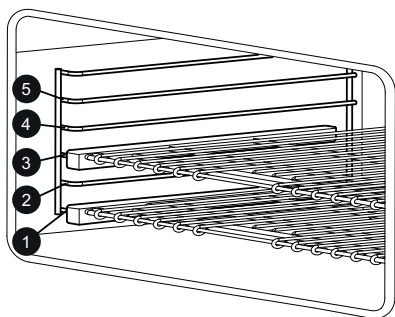

MAIN OVEN CAVITY	
LEVELS	BEST FOR
5	Hamburgers, steaks, toasting bread, broiling most meats, melting cheese
4	Best for two rack cooking. Broiling in Gas units.
3	Most baked goods on cookie sheet or baking pan, frozen foods, cakes, casseroles, frozen pizza
2	Roasting most meats
1	Large roasts, turkey, angel food cake

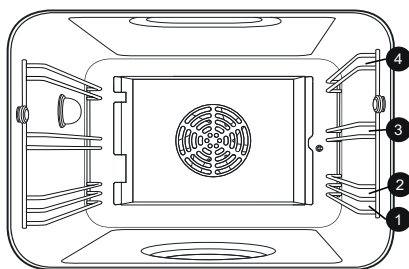

STEAM OVEN CAVITY	
LEVELS	BEST FOR
4	Best for two rack cooking
3	Vegetables, fish, rice, reheat pizza
2	Most baked goods on cookie sheet or baking pan, roasting most meats, frozen foods, cakes, casseroles, frozen pizza
1	Large roasts, turkey, angel food cake

---

## OPERATION

### SETTING THE KITCHEN TIMERS

1. Press **ENTER**. With the **+/-** buttons, move the arrow (>) to **KITCHEN TIMER** and press **ENTER** again.
2. Using the **+/-** buttons, select the desired countdown time in 1 minute increments. Hold down **+/-** button to set by 5 minute increments. Press **ENTER** to begin the timer countdown.
  - When the timer reaches “0:00”, the display will emit a repeated beep to signal the end of the countdown.
3. Press **CANCEL** to disable the beep.

### USING THE MEAT PROBE

1. Insert the plug end into the outlet and the probe end into the meat.
2. Close the oven door.
3. Select the desired *COOKING MODE* and *OVEN TEMPERATURE* using the knobs on the control panel. Press **ENTER**.
4. With the **+/-** buttons, set the desired *PROBE TEMPERATURE*. Press **ENTER**.

### SETTING EASY COOK<sup>®</sup> PROGRAMS

1. Turn the Mode Selector Knob to *EASY COOK*.
2. Use the **+/-** buttons to scroll through the list of choices. Select the desired food grouping and press **ENTER**.
3. Use the **+/-** buttons to scroll through the sub-group choices under that food grouping. Press **ENTER**.
4. Use the **+/-** buttons to adjust the weight. Press **ENTER**.
5. The display will show the rack level and specific ovenware/accessories that should be used. Press **ENTER**.

### STEAM-CLEANING THE OVEN

**NOTE: Steam Cleaning requires 3 start/stop cycles to complete its operation. Steam Clean cannot be aborted once started. All three cycles must be completed before the appliance will become operational again.**

1. Let the oven cool down and remove any accessories. Using a cleaning sponge, clean the evaporator dish.
2. Fill the water tank to MAX.
3. Add a drop of dishwashing liquid to the evaporator dish.
4. On the display, under the SETTINGS menu, scroll with the **+/-** buttons to STEAM CLEAN and press **ENTER**.
5. The display will then show START STEAM CLEAN? YES. Press **ENTER** again.

#### Cleaning Phase (cycle 1)

At the end of the cleaning phase (about 30 minutes), the countdown will be suspended and a buzzer will sound. The display will show CLEAN DISH on the first line and PRESS ENTER BUTTON on the second line. **DO NOT** press ENTER before following the instructions below.

#### First Rinse (cycle 2)

1. Wipe out the food residues from the oven and the evaporator dish. Thoroughly rinse out the cleaning sponge.
2. Check the water tank, refill it, and slide it back in. Press **ENTER** to start the first rinse cycle. After a short time (about 20 seconds), a beep will signal the end of the first rinse. The display will show CLEAN DISH on the first line and PRESS ENTER BUTTON on the second line.
3. Using the cleaning sponge, wipe out the evaporator dish. Thoroughly rinse out the cleaning sponge.

#### Second Rinse (cycle 3)

1. Press **ENTER** to start the second rinse cycle. The countdown will resume, and after another 20 seconds a beep will signal the end of STEAM CLEAN.
2. Using the cleaning sponge, wipe any remaining water from the evaporator dish, and wipe down the oven. Thoroughly rinse out the cleaning sponge. Using a soft cloth, dry the oven cavity.

# COOKING CHARTS



Note: Cook times are approximate and may vary depending on the food.

TYPE	FOOD	RECOMMENDED MODE	OVEN TEMP.	NO. OF RACKS	RACK POSITION(S)	TIME (MINUTES)
<b>BAKED GOODS</b>						
<b>Cakes</b>	Cupcakes	Bake	350°F	1	3	17 - 24
		Convection Bake	325°F	2	2 & 4	17 - 23
		Convection Bake	325°F	3	1, 3 & 5	17 - 23
	Cakes	Bake	350°F	1	3	23 - 31
Convection Bake		325°F	2	2 & 4	23 - 30	
<b>Cookies</b>	Brownies	Bake	350°F	1	3	33 - 41
		Convection Bake	325°F	1	3	33 - 40
	Cookies	Bake	350°F	1	3	8 - 17
		Convection Bake	325°F	2	2 & 4	8 - 17
		Convection Bake	325°F	3	1, 3 & 5	8 - 17
	<b>Breads</b>	Biscuits/Muffins	Bake	350°F	1	3
Convection Bake			325°F	2	2 & 4	10 - 20
Convection Bake			325°F	3	1, 3 & 5	10 - 20
Quick Bread		Convection Bake	350°F	1	2	48 - 60
Yeast Bread		Convection Bake	400°F	1	2	22 - 35
<b>Pie</b>	Fruit, Fresh	Bake	400°F	1	2	35 - 50
	Pumpkin	Bake	425°F	1	2	15
		Bake	350°F	1	2	35 - 45
<b>Pizza</b>	Frozen, thin crust	Bake	425°F	1	3	recipe time
	Frozen, thick crust	Bake	425°F	1	3	recipe time
	Fresh	Bake	425°F	1	3	recipe time
<b>Entrees</b>	Casseroles	Bake	350 - 400°F	1	3	per recipe
	Frozen (nuggets, fish sticks, fries)	Bake	per package	1	3	per package
	Garlic Bread	Broil	Broil		5 – Dual Fuel 4 – Gas	15 - 30
	Quiche	Bake	425°F	1	3	15 - 30
	Vegetables, roasted	Roast / Convection Roast	400 - 500°F	1	3	15 - 30

TYPE	FOOD	RECOMMENDED MODE		OVEN TEMP.	RACK	INTERNAL TEMPERATURE	TIME (MINUTES)
		Non-Conv	Convection				
<b>MEAT, FISH, POULTRY</b>							
<b>Beef</b>	Chuck Roast (2-3 lbs)	Roast	Roast	350°F	2	Well, 170°F	1 1/2 - 2 hr
	Beef roast boneless 3 - 5.5 lbs	Roast	Conv Roast	325°F	2	Med-rare, 145°F	18-33 min/lb
	Beef roast boneless 3 - 5.5 lbs	Roast	Conv Roast	325°F	2	Medium, 160°F	30-35 min/lb
	Steaks, 1 inch thick	Broil	Broil	Broil	4	Med-rare, 145°F	side 1 - 5-8 min. side 2 - 14-6 min.
	Steaks, 1 inch thick	Broil	Broil	Broil	4	Medium, 160°F	side 1 - 8-9 min. side 2 - 5-7 min.
	Meatloaf, 1 - 2 lbs.	Roast	Roast	350°F	3	160°F	50 - 60 min.
<b>Pork</b>	Pork Loin Roast, 1.5 - 3 lbs.	Roast	Conv. Roast	350°F	2	Medium, 160°F	19 - 36 min/lb
	Pork Loin Roast, 3 - 6 lbs.	Roast	Conv. Roast	350°F	2	Medium, 160°F	19 - 36 min/lb
	Tenderloin, 1.5 - 3 lbs.	Roast	Conv. Roast	425°F	2	Medium rare, 145°F	15 - 28 min/lb
<b>Poultry</b>	Chicken breasts, bone-in	Broil	Conv. Broil	Broil	2	170° F	side 1 - 18-22 min. side 2 - 12-13 min.
	Chicken thighs, bone-in	Broil	Broil	Broil	3	180° F in thigh	side 1 - 14-15 min. side 2 - 17-20 min.
	Chicken, whole 3.5 - 8 lbs.	Roast	Conv. Roast	375° F	2	180° F in thigh	13 - 20 min/lb
	Turkey, unstuffed, 12 - 19 lbs.	Roast	Conv. Roast	325° F	2	180° F in thigh	9 - 14 min/lb
	Turkey, unstuffed, 20 - 25 lbs.	Roast	Conv. Roast	325° F	2	180° F in thigh	6 - 12 min/lb
<b>Fish</b>	Fish Filets, 3/4" to 1" thick	Broil	Broil	Broil	3	145° F	11 - 15 min.

\* In models with convection. The convection temperatures have been reduced 25°F from the recipe's or package's directions.

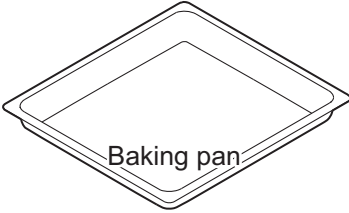
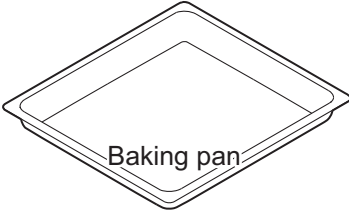
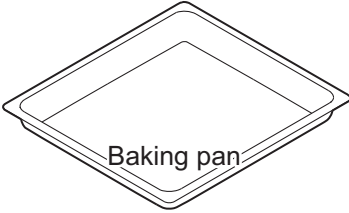
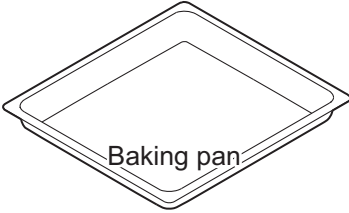
## COMMONLY COOKED FOODS COOKED IN THE BUILT-IN STEAM AND CONVECTION OVEN

FOOD	MODE	TEMP	MINUTES	LEVELS	ACCESSORIES	
<b>FROZEN PRODUCTS</b>						
French fries	True Conv	375°F	25 – 35	2		
Lasagna, frozen	Steam Conv	375°F	35 – 55	2		
Pizza, thin crust	True Conv	375°F	15 – 23	2		
Pizza, deep dish	True Conv	375°F	18 – 25	2		
Frozen fish fillets	Steam Conv	375°F	35 – 50	2		
<b>POULTRY   MEATS   SEAFOOD</b>						
Chicken, whole 2.65 lbs.	Steam Conv	375°F	50 – 60	2		
Chicken pieces, per 2.65 lbs.	Steam Conv	375°F	20 – 35	2		
Turkey, whole, unstuffed	Steam Conv	325°F	80 – 95	2		
Pot-roasted beef, 3.5 lbs.*	Reheat	300°F	100 – 140	2		
Filet of beef, medium, 2 lbs.*	Reheat	350°F	20 – 28	2		
Thick sliced sirloin, med.; 2 lbs.*	True Conv	350°F	45 – 60	2		
Pork chop, boneless, 1.2 lbs.	Steam Conv	300°F	75 – 120	2		
Clams, oysters, 0.33 lbs.	Steam	212°F	10 – 15	2		
Meat loaf (ground meat), 1.2 lbs.	Steam Conv	350°F	45 – 60	2		
<b>STARCHES   GRAINS   BREADS</b>						
Potato gratin	Steam	212°F	35 – 45	2		
Brown rice	Steam	212°F	30 – 40	2		
Long grain rice	Steam	212°F	20 – 30	2		
Lentils	Steam	212°F	30 – 45	2		
Couscous	Steam	212°F	6 – 10	2		
Canellini beans (pre-softened)	Steam	212°F	65 – 75	2		
White bread, 1.7 lbs.	Steam Conv	400°F	15 – 20	2		
Multi-grain bread,	Steam Conv	400°F	15 – 20	2		
Whole grain bread, 1.7 lbs.	Steam Conv	400°F	20 – 30	2		
Biscuits*	True Conv	300°F	12 – 17	2		
<b>SLOW COOK</b>						
Boned leg of lamb, 2 – 3.5 lbs.	Slow Cook	175°F	140 – 160	2		
Roast beef, 3.5 – 5.5 lbs.	Slow Cook	175°F	150 – 180	2		
Pork fillets	Slow Cook	175°F	50 – 70	2		
Beef steaks, 1.2" thick	Slow Cook	175°F	40 – 80	2		
Duck breast	Slow Cook	175°F	35 – 55	2		
<b>REHEATING FOODS</b>						
Pizza	Reheat	350°F	12 – 15	3		
Vegetables	Reheat	250°F	12 – 18	2		
Bread*	Reheat	350°F	8 – 12	2		
Noodles, potatoes, rice	Reheat	210°F	5 – 10	3		
<b>CAKES   SMALL BAKED PRODUCTS</b>						
Muffins**	True Conv	350°F	20 – 30	2		
Sponge cake**	True Conv	300°F	60 – 70	2		
Chocolate chip cookies**	True Conv	325°F	9 – 13	3		
Sugar cookies**	True Conv	325°F	7 – 10	3		
Sheet cake**	Steam Conv	325°F	35 – 45	2		
Bundt®**	True Conv	325°F	35 – 45	2		
Yeast dough, proofing**	Proof	100°F	20 – 30	1		
Sourdough, proofing**	Proof	100°F	20 – 30	1		

\*\*Customer should use their own bakeware.

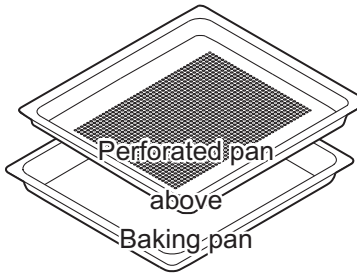
FOOD	MODE	TEMP	MINUTES	LEVELS	ACCESSORIES	
<b>POTATOES   FISH</b>						
Potatoes (unpeeled)	Steam	212°F	35 – 45	1 + 3	 <p>Perforated pan above Baking pan</p>	
Potatoes (peeled)	Steam	212°F	20 – 25	1 + 3		
Shrimp, medium, per 1 lb	Steam	212°F	5 – 8	1 + 3		
Fish Fillet, per 3.5 lbs. (baking pan only, or customer dish on rack)	Steam	180°F	10 – 20	1 + 3		
<b>DEFROSTING FOODS</b>						
Chicken parts, bone-in	Defrost	120°F	60 – 70	1 + 3		
Chicken parts, boneless	Defrost	120°F	30 – 35	1 + 3		
Frozen vegetables	Defrost	120°F	20 – 30	1 + 3		
Fish fillets	Defrost	120°F	15 – 20	1 + 3		
Beef	Defrost	120°F	70 – 80	1 + 3		
<b>VEGETABLES</b>						
Artichokes	Steam	212°F	30 – 35	1 + 3		
Asparagus*	Steam	212°F	7 – 12	1 + 3		
Beets	Steam	212°F	40 – 50	1 + 3		
Broccoli	Steam	212°F	8 – 10	1 + 3		
Brussels sprouts	Steam	212°F	20 – 30	1 + 3		
Cabbage	Steam	212°F	25 – 35	1 + 3		
Carrots	Steam	212°F	10 – 20	1 + 3		
Cauliflower	Steam	212°F	10 – 15	1 + 3		
Fennel	Steam	212°F	10 – 14	1 + 3		
Green beans	Steam	212°F	15 – 20	1 + 3		
Peas	Steam	212°F	5 – 10	1 + 3		
Pea pods	Steam	212°F	8 – 12	1 + 3		
Spinach*	Steam	212°F	2 – 3	1 + 3		
Stuffed vegetables (zucchini, eggplant, peppers)	Steam Conv	320 – 360°F	15 – 30	1 + 3		
Zucchini	Steam	212°F	2 – 3	1 + 3		

## HANDY HINTS

### Care

#### CLEANING BURNER CAPS AND BASES

Wash with hot soapy water, rinse and dry thoroughly. Mild abrasive cleaners such as Bon Ami® or other mild abrasive cleaners such as Soft Scrub® may be used. Use a stiff nylon bristle brush to clean port openings. When reassembling, make sure the burner cap is seated on the base. Cleaners with chlorine should be avoided.

#### CLEANING THE SPILL TRAYS

Cooktop spill trays should be cleaned with warm soapy water, rinsed well, and then dried thoroughly after each use. Spill trays can be soaked to soften the soil. An all-purpose cleaner such as Fantastik® may be used. Burned-on food can be removed with Bon Ami® or other mild abrasive cleaners such as Soft Scrub®.

Apply all cleaners with care — soap-filled fiber or steel wool pads may scratch the spill trays. After cleaning, maintops can be wiped with glass cleaners, such as Windex®, for a shiny finish. Cleaners with chlorine should be avoided.

#### CLEANING THE GRIDDLE OR GRILL

Clean the griddle or grill surface with warm soapy water, rinse well, and wipe dry with a soft cloth. If food particles stick to the griddle plate, remove with a mild abrasive cleaner such as Soft Scrub®. Never flood a hot griddle or grill with cold water as this can warp or crack the aluminum plate. Cleaners with chlorine should be avoided.

#### OVEN CLEANING

Before cleaning self-cleaning ovens, remove all racks and utensils from the oven and wipe up any puddles of grease and loose soil. Remove any soil from outside the door seal area. Make sure the light bulbs and glass covers are in place. Turn on the ventilator hood above the range and leave it on until the oven has completed the self-clean cycle. After setting the oven to self-clean, wait until the clean light comes on then confirm that the oven door is locked. After the clean cycle is complete and the oven has cooled, wipe out the ash in the bottom of the oven.

Ovens can be washed with hot soapy water. Mild cleaners such as Bon Ami<sup>®</sup>, Bar Keepers Friend<sup>®</sup>, or Soft Scrub<sup>®</sup> can be used. Cleaners with chlorine should not be used.

### **STEAM OVEN CLEANING**

Steam oven models should have the water tank emptied after each use. Thoroughly dry the seal of the tank lid and the slot where the tank resides. Prolonged dampness could lead to a musty odor in the tank. Using the sponge provided with your range (or a comparable soft sponge or cloth), wipe out the oven and remove any remaining water so that the evaporator dish in the bottom of the oven is dry. Remove any possible limescale deposits with vinegar. Cleaners with chlorine should not be used.

Use only fresh tap water, or if necessary, plain non-carbonated purchased water to fill water tank. Use the descaling tablets supplied with the appliance or a commercial citric acid based descaling agent to descale the appliance. Follow the manufacturer's instructions on the packaging.

## **Use**

### **EXTRALOW<sup>®</sup> BURNERS**

Several of the controls have flame settings even lower than the standard SIM setting. When the knob is set within this range, the flame cycles on and off. These settings are suitable for simmering and poaching, melting chocolate, and holding cooked foods at temperatures without scorching or burning.

### **SETTINGS AND COOKWARE TO USE**

The type and quantity of food affects which setting to use. Higher settings may be needed for large quantities of food.

The cooking utensil affects the setting. Its size, type, material, and whether a lid is used, all affect the consistency of the cooking temperature.

To maintain a low or simmer heat setting, bring food to a boil. Stir well then cover the pan and lower the heat to the desired setting. Check periodically to determine if the control knob should be turned to another setting.

If an over-sized pan is used, the simmer action may occur mainly in the center of the pan. To equalize the temperature throughout the food, stir the food around the outer edges of the pan into the food in the center.

It is normal to stir food occasionally while simmering. This is especially important when simmering for several hours.

When lowering the flame setting, adjust it in small steps. If the setting is too low to hold a simmer, bring the food back to a boil before re-setting to a higher heat.

Use cookware that has good heat conductivity, good balance, a flat and correctly-sized base to fit the burner, and a properly fitting lid. A 5½" base size is generally the smallest pan recommended.

A properly fitting lid will shorten cooking time and make it possible to use a low heat setting.

When using two extra large stock pots at one time, do not use adjacent burners; use staggered burners to provide adequate air around the burners.

### **USING THE OVEN**

Preheat the oven to the desired setting when preparing baked products. The preheat time is calibrated to provide the best baking results, so do not bake until the oven is preheated. The oven does not need to be preheated for roasting meats.

Use the proper bakeware for baking. Warped, lightweight pans or pans with tall sides do not yield high quality baked products. Cookies should be baked on a flat sheet with a lip on one side. For better browning, baking pans should be placed crosswise on the rack with the shorter sides on the right and the left. This allows the air to circulate freely.

For tender, golden crusts use light non-stick anodized or shiny metal pans. For crisp brown crusts, use dark non-stick/anodized or dark dull metal utensils or glass bakeware. These may require lowering the temperatures 25°F when using convection bake. There is no need to reduce the temperature when roasting meats.

It is recommended to reheat dishes or leftovers slowly between 230°F and 265°F until an internal thermometer reaches 165°F.

### **USING THE STEAM OVEN**

Avoid opening the door during the steaming phase as this can significantly increase the cooking time. When using any steam mode place food in oven before preheat.

## RECIPE FOR SAFER COOKING

Follow these tips to protect you and your family when in the kitchen. Whether stirring up a quick dinner or creating a masterpiece four-course meal, here's a recipe for safer cooking you need to use daily.

### To Prevent a Cooking Fire in Your Kitchen



Keep an eye on your cooking and stay in the kitchen. Unattended cooking is the #1 cause of cooking fires.



Wear short or close-fitting sleeves. Loose clothing can catch fire.



Watch children closely. When old enough, teach children to cook safely.



Clean cooking surfaces to prevent food and grease build-up.



Keep curtains, towels and pot holders away from hot surfaces, and store solvents and flammable cleaners away from heat sources. Never keep gasoline in the house.

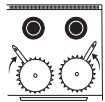

Turn pan handles inward to prevent food spills.

### To Put Out a Cooking Fire in Your Kitchen

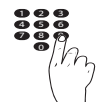

Call the fire department immediately. In many cases dialing 911 will give you Emergency Services.



Slide a pan lid over flames to smother a grease or oil fire then turn off the heat and leave the lid in place until the pan cools. Never carry the pan outside.



Extinguish other food fires with baking soda. Never use water or flour on cooking fires.



Keep the oven door shut and turn off the heat to smother an oven or broiler fire.



Keep a fire extinguisher in the kitchen. Make sure you have the right type and training.



Keep a working smoke detector in your home and test it monthly.