

*Fisher & Paykel*

Aerotech oven  
OB30 models

**User guide**

US CA



---

This user guide is an accompaniment to your 'Quick start guide' which is included with your oven.

For operating instructions, and to get going with your new oven see your 'Quick start guide'. If you no longer have your 'Quick start guide', you can download it from our local website, listed on the back cover.

**Refer to your 'Quick start guide' for information on:**

- Setting the clock
  - Controls
  - Positioning the shelves
  - Conditioning the oven before first use
  - Using the timer
-





Safety and warnings	5
Cooking guide	14
Oven functions	17
Cooking charts	22
Automatic cooking	30
Using the meat probe	34
User preference settings	36
Sabbath setting	38
Care and cleaning	40
Using the Self Clean function	45
Troubleshooting	49
Alert codes	54
Warranty and service	56

## ***Important!***

### **SAVE THESE INSTRUCTIONS**

*The models shown in this user guide may not be available in all markets and are subject to change at any time. For current details about model and specification availability in your country, please visit our website listed on the back cover or contact your local Fisher & Paykel dealer.*

## Safety and warnings

Your oven has been carefully designed to operate safely during normal cooking procedures. Please keep the following safety instructions in mind when you are using it:

### ⚠ WARNING!



#### Electrical Shock Hazard

Turn the oven off at the wall before replacing the oven lamp.

Failure to follow this advice may result in death or electrical shock.

### ⚠ WARNING!



#### Fire Hazard

Follow the instructions on starting a Self Clean cycle carefully. Items made from combustible materials (for example: wood, fabric, plastic) may catch fire if left in the oven during a Self Clean cycle.

Do not place aluminium foil, dishes, trays, water or ice on the oven floor during cooking, as doing so will irreversibly damage the enamel; lining the oven with aluminium foil may even cause fire.

Never use your appliance for warming or heating the room. Persons could be burned or injured or a fire could start.

Storage in or on appliance: flammable materials should not be stored in an oven or near its surface.

Failure to follow this advice may result in overheating, burning, and injury.

### ⚠ WARNING!



#### Hot Surface Hazard

Accessible parts may become hot when in use.

To avoid burns and scalds, keep children away.

Use oven mitts or other protection when handling hot surfaces such as oven shelves or dishes.

Use care when opening the oven door. Let hot air or steam escape before removing or replacing food.

Do not touch heating elements or interior surfaces of the oven. Heating elements may be hot even though they are dark in color. Interior surfaces of an oven become hot enough to cause burns. During and after use, do not touch, or let clothing or other flammable materials contact heating elements or interior surfaces of the oven until they have had sufficient time to cool. Other surfaces of the appliance may become hot enough to cause burns - among these surfaces are the oven vent, the surface near the oven vent, and the oven door.

Failure to follow this advice could result in burns and scalds.

**⚠ WARNING!****Cut Hazard**

Take care - some edges are sharp.

Failure to use caution could result in injury or cuts.

## *Important safety instructions*

To reduce the risk of fire, electrical shock, injury to persons or damage when using the oven, follow the important safety instructions listed below:

- *Read all the instructions before using the oven. Use the oven only for its intended purpose as described in these instructions.*
- *Proper installation: be sure your appliance is properly installed and grounded by a qualified technician.*
- *Isolating switch: make sure this oven is connected to a circuit which incorporates an isolating switch providing full disconnection from the power supply.*
- *Household appliances are not intended to be played with by children.*
- *Do not leave children alone. Children should not be left alone or unattended in the area where the appliance is in use. They should never be allowed to sit or stand on any part of the appliance.*
- *Children of less than 8 years old must be kept away from the appliance unless continuously supervised. This appliance can be used by children aged from 8 years and above, and persons with reduced physical, sensory or mental capabilities or lack of experience and knowledge, if they have been given supervision or instruction concerning the use of the appliance in a safe way and they understand the hazards involved. Cleaning and user maintenance shall not be done by children without supervision.*
- *Do not place heavy objects on the oven door.*
- *Wear proper apparel. Do not wear loose fitting or hanging garments when using the appliance. They could ignite or melt if they touch an element or hot surface and you could be burned.*
- *User servicing: do not repair or replace any part of the appliance unless specifically recommended in the manual. All other servicing should be referred to a qualified technician.*
- *Do not use water on grease fires. Smother the fire or flame or use a dry chemical or foam type extinguisher.*

## *Important safety instructions*

- *Use only dry oven mitts or potholders. Moist or damp potholders on hot surfaces could result in burns from steam. Do not let potholders touch hot areas or heating elements. Do not use a towel or a bulky cloth for a potholder. It could catch fire.*
- *Do not heat unopened food containers. They can build up pressure that may cause the container to burst and result in injury.*
- *Safe food handling: leave food in the oven for as short a time as possible before and after cooking. This is to avoid contamination by organisms which may cause food poisoning. Take particular care during warm weather.*
- *Always keep oven vents unobstructed.*
- *Do not operate your appliance by means of an external timer or separate remote-control system.*
- *Caution: Hot air can blow from the vent at the base of the oven as part of the oven's cooling system.*
- *Placement of oven shelves: always position shelves in the desired location while the oven is cool (before preheating). If a shelf must be removed while the oven is hot, do not let the oven mitts or potholder contact hot heating elements in the oven or the base of the oven.*
- *Do not clean the oven seal or use any oven-cleaning products on it. It is essential for a good seal, which ensures that the oven operates efficiently. Care should be taken not to rub, damage or move it.*
- *Do not use oven cleaners, harsh/abrasive cleaning agents, waxes, or polishes. No commercial oven cleaner, oven liner, or protective coating of any kind should be used in or around any part of the oven. Do not use harsh/abrasive cleaners, scourers or sharp metal scrapers to clean the oven door glass since they scratch the surface, which may result in the glass shattering.*
- *Clean only the parts listed in this manual.*
- *Do not use a steam cleaner to clean any part of the oven.*
- *Double oven models only:  
You can only Self Clean one oven at a time, and whilst in a Self Clean cycle, the other oven cannot be used.*

## ***Important safety instructions***

- *Before starting a Self Clean cycle, remove oven shelves, side racks, and all other cookware/ utensils, and wipe up large food spills or grease deposits.*
- *Before starting a Self Clean cycle, make sure you move any pet birds to another, closed and well-ventilated room. Some pet birds are extremely sensitive to the fumes given off during a Self Clean cycle and may die if left in the same room as the oven during such a cycle.*
- *During a Self Clean cycle, the oven reaches higher temperatures than it does for cooking. Under such conditions, the surfaces may get hotter than usual and children should be kept away.*
- *Do not store things children might want above the oven. Children could be burned or injured while climbing on the oven to retrieve items.*
- *Do not install or operate the appliance if it is damaged or not working properly. If you receive a damaged product, contact your dealer or installer immediately.*
- *Use only bakeware approved for oven use. Follow the bakeware manufacturer's instructions.*
- *The California Safe Drinking Water and Toxic Enforcement Act requires businesses to warn customers of potential exposure to substances which are known by the State of California to cause cancer or reproductive harm. Small amounts of harmful chemicals are given off in the oven's self-cleaning cycle from insulation and food decomposition. Significant exposure to these substances can cause cancer and reproductive harm. Venting with a hood or open window, and wiping out excess food spills prior to self-cleaning the oven reduces exposure.*

## Cooking guide

Congratulations on your new purchase. Your Fisher & Paykel oven has a number of features to make cooking a great experience for you:

- a wide choice of oven functions
- a convenient Self-Clean function – see ‘Using the Self Clean function’
- intuitive controls and displays
- illuminated halos around the dials for visual feedback

### Before you start

- Make sure the installer has completed the ‘Final checklist’ in the Installation instructions.
- Read this guide, taking special note of the ‘Safety and warnings’ section.
- Remove all packaging and dispose of it responsibly. Make sure all cable ties used to secure the shelves during shipping have been removed. Recycle items that you can.
- Check that you have all the accessories listed in the separate ‘Quick start guide’.
- Make sure you follow the instructions under ‘Setting the clock and first use’ in the separate ‘Quick start guide’ before using your oven.

### General guidelines

This oven has been designed to utilise its four elements and rear fan in differing combinations to provide you with enhanced performance and a wide range of functions, allowing you to cook all types of food to perfection.

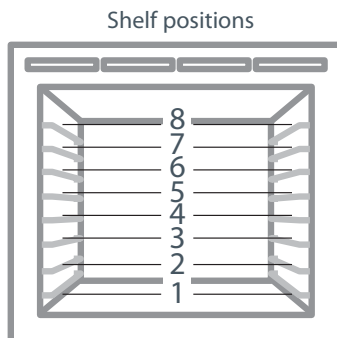
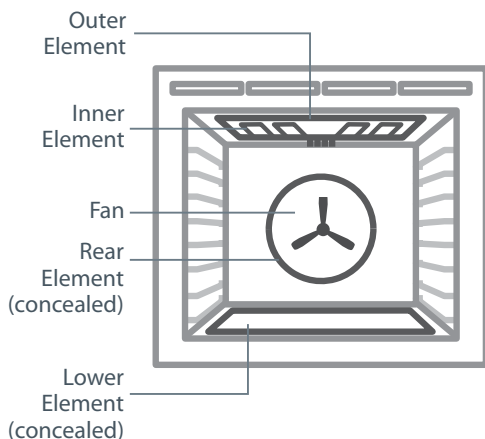

## BAKING

- For best results when baking, always pre heat your oven. The grill element may come on for a short time while the oven is heating up. The halo will turn from red to white when the preset temperature is reached.
- Do not open the door until at least  $\frac{3}{4}$  of the way through cooking.
- Make sure cake pans do not touch each other or the sides of the oven.
- When baking double the recipe (especially cookies) you may need to increase the time.
- Your cookware will influence baking times. Dark pans absorb the heat more quickly than reflective pans; glass cookware may require a lower temperature.
- Multi-shelf baking may also require a slight increase in cooking time.
- Always leave a space between shelves when multi-shelf cooking to allow the air to circulate.

### *Shelf Position Guide*

*Place your baking on a shelf that will have the top of your pan near the center of the oven cavity.*

## ROASTING

- Your oven has a dedicated **Roast** function (some models only). This is designed to brown the outside of the meat but still keep the inside moist and juicy.
- Use the meat probe for perfect results. See 'Using the Meat Probe'.
- Boneless, rolled or stuffed roasts take longer than roasts containing bones.
- Poultry should be well cooked with the juices running clear and an internal temperature of 165°F / 75°C.
- If using a roasting bag, do not use the **Roast** function. The initial searing stage is too hot for roasting bags. Use **Aero Bake** or **True Aero** and follow the manufacturer's instructions.
- When using the **Roast** function, do not cover your roast, as this will stop the searing process browning the outside of the meat. If you prefer to roast in a covered pan, use the **Aero Bake** function instead and increase the temperature by 70°F / 20°C.
- Cook larger cuts of meat at a lower temperature for a longer time. The meat will cook more evenly.
- Always roast meat fat side up. That way, basting may not be required.
- Always rest the meat for at least 10 minutes after roasting to allow the juices to settle. Remember the meat will continue to cook for a few minutes after removing it from the oven.

### *Shelf Position Guide*

*Place the meat on a shelf so that the meat is in the center of the oven or lower.*

## **BROILING**

- This is a healthier alternative to frying.
- Always broil with the oven door completely shut.
- If you use glass or ceramic pans, be sure they can withstand the high temperatures of broiling.
- To avoid piercing the meat and letting juices escape, use tongs or a spatula to turn the meat halfway through cooking.
- Brush meat with a little oil to help keep the meat moist during cooking. Alternatively marinate the meat before broiling (but be aware that some marinades may burn easily).
- Where possible broil cuts of meat of a similar thickness at the same time. This will ensure even cooking.
- Always keep a close watch on your food while broiling to avoid charring or burning.
- The three-piece broil/roast system (some models only) provided with your oven (consisting of the pan, grid and rack) has been designed to reduce splatter and smoke, and is therefore ideal for broiling and roasting. We suggest you place meat on the broil/roast rack (on top of the pan and grid) to allow hot air to circulate around it. This gives more even browning and a result similar to a rotisserie.

On occasions, you may want to use only two pieces of the system. For example, when roasting a large turkey, use only the pan and grid for greater stability.

### ***Shelf Position Guide***

- *For thinner cuts of meat, toasting or browning foods, use a higher shelf position.*
- *Thicker cuts of meats should be broiled on lower shelves or at a lower broil setting to ensure even cooking.*

## **REHEATING**

- Use **Bake** or **Aero Bake** to reheat food.
- **Bake** function is particularly good for reheating pastry based items, as the base heat will help re-crisp the pastry case.
- Always reheat food to piping hot. This reduces the risk of contamination by harmful bacteria.
- Once hot, use the **Warm** function to keep the food warm.
- Never reheat a food more than once.

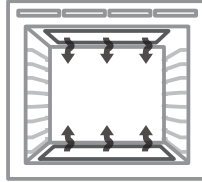

**Bake***upper outer and lower elements*

- Heat comes from both the upper and lower elements. The fan is not used in this function.
- Ideal for cakes and foods that require baking for a long time or at low temperatures.
- This function is not suitable for multi-shelf cooking.

*Ideal for moist foods that take a longer time to cook eg rich fruit cake.*

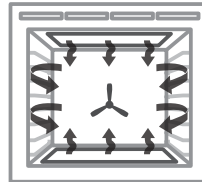
**Aero Bake***fan plus upper outer and lower elements*

- The oven fan circulates hot air from the top outer and the lower elements and distributes it around the oven cavity.
- Food cooked tends to brown more quickly than foods cooked on the traditional **Bake** function.
- You may need to decrease the time from that recommended in traditional recipes.
- Use **Aero Bake** at a low temperature: 120°F / 50°C for drying fruit, vegetables and herbs.

*Ideal for single shelf baking that takes less than an hour to cook – foods such as muffins, English scones and cupcakes or things like enchiladas.*

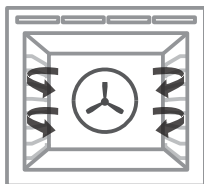
**True Aero*****fan and rear element***

- By using the central rear heating element and fan, hot air is blown into the cavity, providing a consistent temperature at all levels, making it perfect for multi-shelf cooking.
- Trays of cookies cooked on different shelves are crisp on the outside and chewy in the middle.
- Meat and poultry are deliciously browned and sizzling while remaining juicy and tender.
- Casseroles are cooked to perfection and reheating is quick and efficient.
- When multi-shelf cooking it is important to leave a gap between trays (eg use shelves 3 & 5) to allow the air to move freely. This enables the browning of foods on the lower tray.
- If converting a recipe from **Bake** to **True Aero**, we recommend that you decrease the bake time or decrease the temperature by approximately 70°F / 20°C.
- For items with longer bake times (eg over an hour) it may be necessary to decrease both time and temperature.

*Ideal for multi-shelf cooking, cookies, English scones, muffins and cupcakes.*

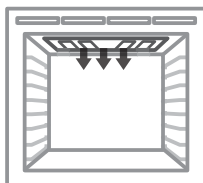

**(some models only)**

**Broil*****upper inner element***

- Intense radiant heat is delivered from the inner top element. There are 9 steps between 'Lo' and 'Hi' (100% power).
- Preheating is not essential although some people prefer to allow the element to heat for a few minutes before they place food under the broil element.
- The temperature halo will remain red while using the broil function.
- The most suitable function for 'finishing off' many meals, for example browning the top of potato gratin and frittata.

*Ideal for toasting bread or for top browning to 'finish off dishes'.*

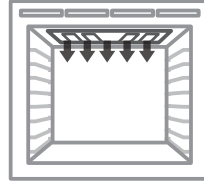
**Maxi Broil*****upper inner and outer elements***

- Intense radiant heat is delivered from both top elements. There are 9 steps between 'Lo' and 'Hi' (100% power).
- Preheating is not essential although some people prefer to allow the element to heat for a few minutes before they place food under the broil element.
- The temperature halo will remain red while using the broil function.
- The most suitable function for 'finishing off' many meals, for example browning the top of potato gratin and frittata.

*Ideal for toasting bread or for top browning to 'finish off dishes.'*

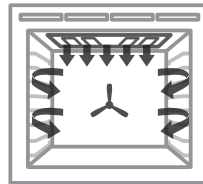
**Aero Broil*****fan plus upper inner and outer elements***

- This function uses the intense heat from the elements for top browning and the fan to ensure even cooking of foods.
- Meat, poultry and vegetables cook beautifully; food is crisp and brown on the outside while the inside remains moist and tender.

*Ideal for whole chicken, tenderloin of beef or broiling your favorite chicken, fish or steak.*

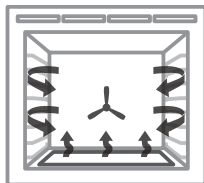

Aero Pastry

**fan plus lower element**

- The fan circulates heat from the lower element throughout the oven.
- Excellent for cooking pizza as it crisps the base beautifully without overcooking the topping.

*Ideal for foods such as sweet and savory pastry foods and delicate foods that require some top browning eg frittata, quiche.*



(some models only)

Roast

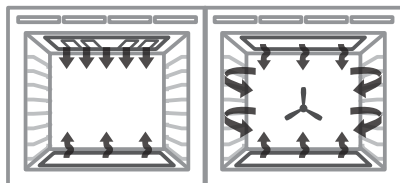
**fan plus upper and lower elements**

- A two-step program. An initial 20 minute searing stage crisps and browns the roast and caramelises the outside of the meat, then the temperature drops to the level you have preset for the remainder of the cooking period, producing a tender and juicy roast that is full of flavour.
- Oven does not require preheating.
- If desired, use the broil rack, grid or place vegetables under the roast to allow the juices to drain away from your meat. This will allow the hot air to circulate under the meat as well.

*Ideal for Roasting meat, chicken and vegetables.*

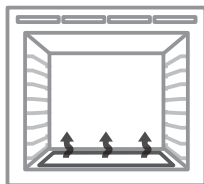

Classic Bake

**lower element only**

- Heat comes from the lower element only, the fan is not used.
- This is the traditional baking function, suitable for recipes that were developed in older ovens.
- Bake on only one shelf at a time.
- The oven will be hotter at the top.

*Ideal for foods that require delicate baking and have a pastry base, like custard tarts, pies, quiches and cheesecake or anything that does not require direct heat and browning on the top.*

**Warm***this is not a cooking function*

- Provides a constant low heat of less than 195°F / 90°C.
- Use to keep cooked food hot, or to warm plates and serving dishes. To reheat food from cold, use another oven function to heat the food piping hot and only then change to Warm, as this function alone will not bring cold food up to a high enough temperature to kill any harmful bacteria.
- Use the Warm function to prove bread. See 'Tips for proving bread'.

**Self Clean***this is not a cooking function*

- The Self Clean cycle takes care of the mess and grime that is traditionally associated with oven cleaning.
- There are two Self-Clean cycles available:
  - Self clean (which takes 5 hours) for normal cleaning and
  - Light self-clean (which takes 4 hours) for lightly soiled ovens.
- See 'Using the Self Clean function' in the User guide for details.

**Tips for dehydrating fruit**

- To obtain high quality dried fruit, select only unblemished, ripe fruit.
- Wash fruit thoroughly and pat dry. Peel if desired. Fruit that is not peeled will take longer to dry. Remove pits, stems or seeds if necessary. Place fruit on a baking tray on a shelf in the oven.
- We recommend using **True Aero** or **Aero Bake** at 120°F / 50°C.

**Tips for proofing bread**

- Your oven provides an ideal sealed environment for proofing bread.
  - 1 Select the Warm function.
  - 2 Adjust the temperature down until the display shows `Lo`.
  - 3 Place dough in a lightly oiled bowl and cover with plastic wrap and/or a clean damp cloth.
  - 4 Place the bowl into the warmed oven on shelf position 1.

Note: some recipes recommend putting water or ice in the oven with the bread dough during baking. The additional moisture improves the bread crust. You must place the water or ice in a heat resistant dish and on an oven shelf in positions 1 or 2. Do not put it directly onto the oven floor. Placing water, ice or any dish or tray directly on the oven floor will irreversibly damage the enamel.

# Cooking Charts

The recommendations in the following charts are guidelines. A lot of factors affect the exact time and temperature required for baking, roasting and broiling. Follow the instructions in your recipe or on packaging and be prepared to adjust the oven settings and cook times to achieve the best possible results for you.

Note: The grill element may come on for a short time while the oven is heating up.

This chart will help you to match your cooking requirements to the most appropriate cooking function. Note: ● Recommended method ○ Alternative method

		True Aero	Aero Bake	Bake	Aero Pastry	Classic Bake	Roast *	Broil *	Maxi Broil	Aero Broil
<b>Baking</b>										
	Bread (rolls)	one shelf	○	○	●					
		two shelves	●							
Bread (loaf)			○	○	●					
Cookies/Muffins/Sugar cookies	one shelf		○	●	○					
	two shelves		●							
Cup cakes/Small cakes	one shelf		○	●	○					
	two shelves		●							
Layer cake (8"/20cm or 9"/23cm round pans)	one shelf		○		●					
	two shelves		○		●					
Angel food cake		●		○						
Pound cake				●						
Layer cake (9"x13"/23x33cm pan)		○	○	●						
Butter or chocolate cake		○		●						
Rich fruit cake				●		○				
Brownie (9"x13"/23x33cm pan)		●		○	○					
Meringues		●		○						
Fruit pie (two-crust)			●	○						
Pumpkin pie	from scratch			●	○	○				
	frozen			●	○	○				
English custard tart						●				
Baked cheesecake					●	○				
Crème caramel and Crème brulee (in 'water bath')					○	●				
Pie crust					○	●				
Quiche			○	○	●	○				
Pizza			●	○	○					
Lasagna		○	●	○						
Casserole		●	○	○						
Vegetables			●	○						
Complete oven meal		●								

\* Some models only

This chart will help you to match your cooking requirements to the most appropriate cooking function. Note: ● Recommended method      ○ Alternative method

	True Aero	Aero Bake	Bake	Aero Pastry	Classic Bake	Roast *	Broil *	Maxi Broil	Aero Broil
<b>Roasting</b>									
Roast beef/pork/lamb**	○	○	○			●			○
Roast chicken (whole)	○	○	○						●
Roast chicken (pieces)	○	○	○				○	○	●
Roast turkey	●		○						
Vegetables	○	○	○			●			●
<b>Broiling</b>									
Steak/Chops/Cutlets							○	●	
Fish							○	●	○
Ground meat patties							○	●	○
Vegetables							○	●	○
Toast							○	●	

\* Some models only

\*\* If your model does not have the Roast function, we recommend Bake for large meat joints or Maxi Broil for small meat joints.



True Aero

Shelf

(single; multi)

Temp °F

Temp °C

Time (min)

## Baking

		Shelf (single; multi)	Temp °F	Temp °C	Time (min)
Bread	American sandwich loaf - 9"x5"/23x13cm loaf pan	3	350	175	40-50
Bread	wholewheat loaf - 9"x5"/23x13cm loaf pan	3	375	190	35-45
Cornbread		4	425	215	22-28
Cookies		4	425-450	215-230	10-12
Muffins, large		3	375	175	23-30
English scones		4	425-450	215-230	10-12
Sugar cookies	one shelf	4	375	175	6-10
	two shelves	2 & 6	375	175	7-11
	three shelves	2, 4 & 6	375	175	8-12
Cup cakes/Small cakes		4	365	185	13-18
Layer cakes, yellow, white & chocolate (8"/20cm round pans)	one shelf	4	340-350	170-175	32-38
	two shelves	4 & 6	340-350	170-175	32-38
Layer cake, yellow, white & chocolate (9"/23cm round pans)	one shelf	4	340-350	170-175	27-33
	two shelves	4 & 6	340-350	170-175	27-33
Layer cake, yellow, white & chocolate (9"x13"/23x33cm pan)		4	340-350	170-175	32-38
Fatless sponge cake		4	350	175	30-40
Pound cake	from scratch	2	325	160	70-80
	mix	2	350	175	48-58
Brownie (8"x8"/20x20cm pan)	from scratch	4	350	175	20-25
Angel food cake (10"x4"/25x10cm tube pan)	from scratch	1	325-350	160-175	50-60
	mix	1	350	175	37-47
Meringues		4	250-270	120-130	60-70
Fruit pie (two-crust)	from scratch	2	425 then 375	215 then 190	20 then 25
	frozen	2	375	190	45-65
Pizza	from scratch	4	425-450	215-230	10-15
	frozen	4	375	175	18-25
Lasagna		4	350-375	175-190	40-50
Casserole		3	350-360	175-180	60-90
Vegetables		4	350-375	175-190	30-60



 <b>Aero Bake</b>	<b>Shelf</b> (single; multi)	<b>Temp °F</b>	<b>Temp °C</b>	<b>Time (min)</b>	
<b>Baking</b>					
Bread	American sandwich loaf - 9"x5"/23x13cm loaf pan	2	325-350	170-175	35-50
Bread	wholewheat loaf - 9"x5"/23x13cm loaf pan	2 or 3	350-375	180-190	30-45
Cornbread		4	400-425	210-215	20-25
Cookies		4	400-425	210-215	8-10
Muffins, large		3	375	175	20-25
English scones		4	400-425	210-215	8-12
Sugar cookies		4	375	175	6-10
Cup cakes/Small cakes		4	365	185	13-18
Layer cakes, yellow, white & chocolate (8"/20cm round pans)	one shelf	4	340	170	32-38
	two shelves	4 & 6	340	170	32-38
Layer cake, yellow, white & chocolate (9"/23cm round pans)	one shelf	4	340	170	27-33
	two shelves	4 & 6	340	170	27-33
Layer cake, yellow, white & chocolate (9"x13"/23x33cm pan)		4	340	170	32-38
Fatless sponge cake		4	325-350	160-175	30-40
Pound cake	from scratch	2	325	160	60-75
	mix	2	325-350	160-175	48-58
Brownie (8"x8"/20x20cm pan)		4	325-350	160-175	20-25
Meringues		2	250	120	60
Fruit pie (two-crust)	from scratch	2	400 then 350	200 then 175	20 then 25
	frozen	2	350	175	45-65
Pizza	from scratch	4	425	215	10-12
	frozen	4	375	175	18-20
Lasagna		4	350-375	175-190	35-40
Casserole		3	350	175	60-90
Vegetables		3 or 4	350-375	175-190	30-50

# 20 Cooking Charts

 Bake		Shelf (single; multi)	Temp °F	Temp °C	Time (min)
<b>Baking</b>					
Bread	American sandwich loaf - 9"x5" /23x13cm loaf pan	2 or 3	350	175	40-50
Bread	wholewheat loaf - 9"x5" /23x13cm loaf pan	2 or 3	375	190	35-45
Cornbread		4	425	215	22-28
Cookies		4	425-450	215-230	10-12
Muffins, large		3	375	175	23-30
English scones		4	425-450	215-230	10-12
Sugar cookies		4	375	175	6-10
Cup cakes/Small cakes		4	365	185	15-20
Layer cakes, yellow, white & chocolate (8"/20cm round pans)	one shelf	4	340-350	170-175	32-38
	two shelves	4 & 6	340-350	170-175	32-38
Layer cake, yellow, white & chocolate (9"/23cm round pans)	one shelf	4	340-350	170-175	27-33
	two shelves	4 & 6	340-350	170-175	27-33
Layer cake, yellow, white & chocolate (9"x13"/23x33cm pan)		4	340-350	170-175	32-38
Fatless sponge cake		4	350	175	30-40
Pound cake	from scratch	2	325	160	70-80
	mix	2	350	175	48-58
Rich fruit cake		4	275-300	135-150	3-6 hrs
Brownie (8"x8"/20x20cm pan)	from scratch	4	350	175	20-25
Angel food cake (10"x4"/25x10cm tube pan)	from scratch	1	325-350	160-175	50-60
	mix	1	325-350	160-175	37-47
Meringues		2	250-270	120-130	60-70
Fruit pie (two-crust)	from scratch	2	425 then 375	215 then 190	20 then 25
	frozen	2	375	190	45-65
Pizza	from scratch	4	425-450	215-230	10-15
	frozen	4	375	175	18-25
Lasagna		3 or 4	350-375	175-190	40-50
Casserole		3	350-360	175-180	60-90
Vegetables		3 or 4	350-375	175-190	30-60



**Aero Pastry**
**Shelf      Temp °F      Temp °C      Time (min)**
**Baking**

Pastry shell	baked 'blind'	4	350	175	20-30
Pumpkin pie	bake pastry 'blind' then add filling	4 then 2	350 then 375	175 then 190	20-30 then 30-35
Baked cheesecake	(in 'water bath')	3	300	150	55-60
Quiche	bake pastry 'blind' then add filling	4	350	175	20-30 then 20-30
Pizza	from scratch	4	425	215	10-15
	frozen	4	350	175	18-25
Crème caramel	(in 'water bath')	3	350	175	35-40
Crème brulee	(in 'water bath')	3	275	135	40-45

**Classic Bake**
**Shelf      Temp °F      Temp °C      Time (min)**
**Baking**

Pie crust	baked 'blind'	4	375	190	20-30
English custard tart		2	430 then 300	220 then 150	10 then 30
Baked cheesecake	(in 'water bath')	3	325	160	55-60
Quiche	bake pastry 'blind' then add filling	4	375	190	20-30 then 30-35
Crème caramel	(in 'water bath')	3	350	175	35-40
Crème brulee	(in 'water bath')	3	275	135	40-45
Rich fruit cake		4	275-300	135-150	3-6 hrs

## 22 Cooking Charts

 <b>Maxi Broil &amp;  Broil*</b>	Shelf	Broil setting	Time (min)
<b>Beef</b>			
Steaks - rare	7	HI	8-10
Steaks - medium	6 or 7	HI	10-15
Hamburger ground - patties	6 or 7	HI	12-15
<b>Lamb</b>			
Chops - medium	7	HI	15-20
Chops - well done	7	HI	20-25
<b>Pork</b>			
Chops - well done	7	HI	15-20
Ham steak	6 or 7	HI	15-20
Bacon	7	HI	4-7
<b>Sausages</b>			
Sausages	6 or 7	HI	10-15
<b>Fish</b>			
Filets	6 or 7	HI	8-12
Whole	6 or 7	HI	15-20

\* Some models only



## Aero Broil

		Shelf	Temp °F	Temp °C	Time (min)
<b>Beef</b>					
Boneless roast 1-4 lb/ 450-1800g	rare	4	325	160	18-32 per lb/450g
	medium	4	325	160	25-40 per lb/450g
	well done	4	325	160	30-55 per lb/450g
<b>Lamb</b>					
Chops - medium		6 or 7	400-440	200-225	15-20
Chops - well done		6 or 7	400-440	200-225	20-25
Rack - medium		5	400-410	200-210	20-30
<b>Pork</b>					
Chops - well done		6 or 7	375-410	190-210	20-25
<b>Chicken</b>					
Whole		3	340-360	170-180	30-35 per lb/450g
Boneless pieces		5	350-375	175-190	30-50
Bone-in pieces		5	350-375	175-190	30-50
<b>Fish</b>					
Filets		6 or 7	400-425	200-220	8-12
Whole		6 or 7	400-425	200-220	15-20

**Roasting meat**

We recommend you use the meat probe to accurately judge when meat is cooked to your preference. \*Time per lb/450g\* is a rough guide and should only be used to estimate when the meat will be ready. Cooking with ROAST, TRUE AERO, AERO BAKE, and AERO BROIL will take less time than with BAKE.

	Shelf	Oven Temp °F	Oven Temp °C	Probe** Temp °F	Probe** Temp °C	Time (mins) per lb/ 450 g)	Best Function*
<b>Beef</b>							
Boneless roast - rare	3	325	160	130-140	54-60	18-32	ROAST
Boneless roast - medium	3	325	160	150-160	65-70	25-40	ROAST
Boneless roast - well done	3	325	160	165-175	74-79	30-55	ROAST
Prime or standing rib roast - rare	3	325	160	130-140	54-60	15-30	ROAST
Prime or standing rib roast - medium	3	325	160	150-160	65-70	20-35	ROAST
Prime or standing rib roast - well done	3	325	160	165-175	74-79	25-40	ROAST
<b>Leg of lamb</b>							
With bone - medium	3	325	160	150-160	65-70	18-28	ROAST
With bone - well done	3	325	160	165-175	74-79	20-33	ROAST
Boneless - medium	3	325	160	150-160	65-70	20-35	ROAST
Boneless - well done	3	325	160	170-175	77-79	25-45	ROAST
<b>Veal</b>							
Medium	3	325	160	150-160	65-70	20-43	ROAST
Well done	3	325	160	170-175	77-79	25-45	ROAST
<b>Chicken</b>							
Whole	3	350-375	175-190	170	75	15-20	TRUE AERO

\* Note: If your model does not have the Roast function, we recommend using Aero Broil for whole chickens and small meat joints and Bake for large meat joints.

\*\* Some models only (may be purchased separately).

	Shelf	Oven Temp °F	Oven Temp °C	Probe** Temp °F	Probe** Temp °C	Time (mins per lb/ 450 g)	Best Function
<b>Turkey</b>							
8-15 lb/~3.5-7kg - unstuffed	2	325	160	170	75	12-15	TRUE AERO
8-15 lb/~3.5-7kg - stuffed	2	325	160	170	75	15-20	TRUE AERO
16-24 lb/~7-10kg - unstuffed	1	325	160	170	75	10-15	TRUE AERO
16-24 lb/~7-10kg - stuffed	1	325	160	170	75	15-20	TRUE AERO
<b>Pork</b>							
Boneless roast	3	325	160	160-175	71-79	30-45	AERO BAKE
<b>Venison*</b>							
Rare	4	425	225	120-130	49-54	7½ per 1"/2.5 cm thickness	AERO BAKE
Medium rare	4	425	225	130-140	54-60	9 per 1"/25 cm thickness	AERO BAKE

\*Brown in an oiled skillet or frying pan on high heat prior to roasting. The internal temperature of venison rises more on standing due to the high cooking temperature, therefore the suggested probe settings are lower than other rare or medium rare meats.

\*\* Some models only

- You can set the oven(s) to automatically turn on later, cook for a preset time (cooking time), then automatically turn off at a preset stop time. See the example and instructions below (steps 1 to 7).
- If you start cooking manually and only want the oven to turn off automatically after a set cooking time: simply set the cooking time following steps 1 to 3 below and selecting a function and temperature. The oven will automatically turn off when the cooking time is over.
- Alternatively you can simply set the time of day you wish to the oven to turn off. Follow steps 4 and 5. The oven will automatically turn off when the stop time is reached.
- You may have the timer on at the same time as automatic cooking.
- You cannot use a meat probe when using automatic cooking.
- **Double oven models only:** you may set one or both ovens to cook automatically. If one oven is set for automatic cooking you may still use the other normally.

### ***Important!***

***Safe food handling: leave food in the oven for as short a time as possible before and after cooking or defrosting. This is to avoid contamination by organisms which may cause food poisoning. Take particular care during warmer weather.***

Example: It is 11:05 a.m. You want your food to cook for 1 hour, and you would like it to be ready by lunchtime (12:30 p.m).



## Select function and temperature

### *Double oven models only:*

To set automatic cooking for an oven - press the UPPER or LOWER selector button.

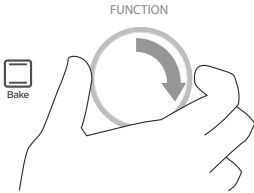

- 1 Select a function.  
The function halo will glow white.

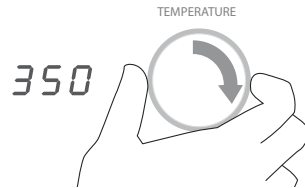

- 2 Adjust the temperature.



- 3 Check the clock shows the correct time of day.



- 4a Press the right scroll ► button twice. The cooking time ⌚ indicator will come on.

*Double oven models only:* the oven indicator will come on.

- 4b Press the select ✓ button to confirm. The display will flash.



- 5a Press the right scroll ► button to set the cooking time. Make sure you allow for preheat time in your calculation.
- 5b Press the select ✓ button to confirm. The display will be steadily lit.

### Set the stop time

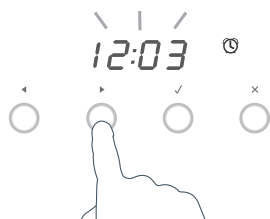

- 6a Press the right scroll ► button to scroll to the stop time ⌚ indicator.
- 6b Press the select ✓ button to confirm. The display will flash.

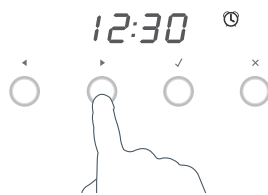

- 7a Press the right scroll ► button to set the time you would like your food to be ready by (ie the stop time).
- 7b Press the select ✓ button to confirm. The display will be steadily lit.

## **Double oven models only:**

To set automatic cooking for the second oven - press the UPPER or LOWER selector button to select the second oven and repeat steps 1-7 above.

## **When automatic cooking is set**

- The oven and the lights will stay off, the halos will be unlit, but your oven is now set for automatic cooking. It will automatically turn on at the required time.
- In a few seconds, the display will show the time of day with the cooking time ☺ and stop time ☹ indicators lit and oven indicator light of the currently selected oven (**double oven models only**).
- Note: you can modify the function and temperature while the oven is waiting to start cooking.

## **When the stop time is reached**

The oven will automatically turn off and a long tone will sound.

## **To check the set cooking time and stop time**

**(Double oven models only:** Press the UPPER or LOWER button to select the oven you wish to check).

Use the scroll ◀ ▶ buttons.

## **To change the cooking or stop time**

**(Double oven models:** Press the UPPER or LOWER button to select the oven you wish to adjust).

Use the right scroll ▶ button to scroll to the cooking time ☺ or the stop time ☹, press ✓ to select the one you want change and use the scroll ◀ ▶ buttons to change the time. Press ✓ to confirm.

## **To see the current time of day**

Press the cancel × button.

## **To cancel automatic cooking**

Turn the function dial to **Off** ☐.

## 30 Using the meat probe

The meat probe is supplied with some models only. For other models it may be purchased separately. For further information or to purchase a meat probe, contact Customer Care, your authorised service centre or visit our website [www.fisherpaykel.com](http://www.fisherpaykel.com).

### Using the meat probe

Use your meat probe to accurately judge when your meat is perfectly cooked. You can use the probe with any function.

**Double oven models only:** you can use the meat probe in either oven. Press the UPPER or LOWER selector button to select the oven you wish to use and then follow the steps below.



- 1 Select the oven function and temperature. Preheat the oven if appropriate. Remember **Roast** and **Aero Broil** do not require preheating.

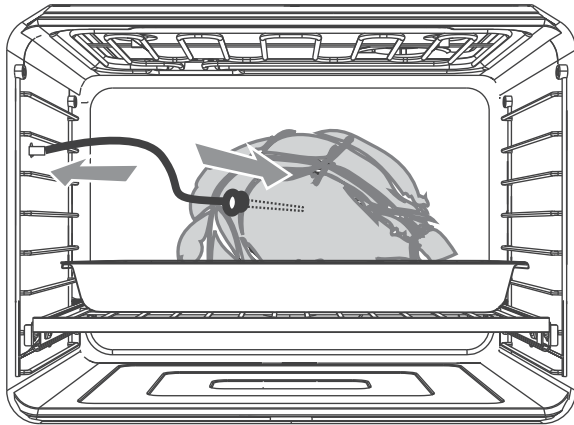

- 2 Insert the metal probe horizontally into the center of the thickest part of the fully defrosted meat. The thicker the meat, the longer it will take to cook, so it is important that the probe is measuring the temperature of the meat at its thickest point. Make sure the probe does not touch bone, fat or gristle, as these will heat up more quickly than the lean meat.
- 3 Place the meat in the roasting (or other suitable uncovered) dish.
- 4 When the oven has preheated (if required) to the set temperature, place the dish in the oven and insert the plug end of the meat probe into the probe socket, using an oven mitt if the oven is hot. The probe socket is on the left hand side of the oven, between shelf positions 4 and 5. Make sure the probe is pushed completely into the socket, then close the oven door.



**4a** Press the right scroll ► button 4 times and the meat probe indicator will come on and the display will show 148.

**4b** Press the select ✓ button to confirm.

- The display will then flash 148.

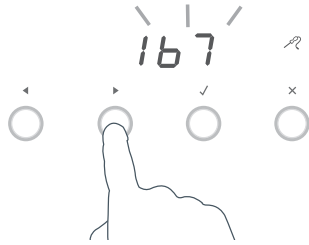

**5** Use the scroll ◀ ▶ buttons to set the required meat temperature (eg 167°F / 75°C).



- 6** Press select to confirm:
- the meat probe indicator will remain on
  - the display will alternate between the set temperature and the internal temperature of the meat.

### To cancel the meat probe at any stage

Press and hold the cancel × button until the display returns to the time of day.

**7a** When the preset temperature is reached:

- a tone will sound every 15 seconds
- the oven will turn off
- the display will show time of day.

**7b** Press the cancel × button to cancel the tone.

### Tips for using the meat probe

- You can still use the timer when the meat probe is in use.
- You cannot use the meat probe with Automatic cooking.
- The internal temperature of the meat will continue to rise by 35-45°F / 2-8°C after you have removed it from the oven, so allow for this in your calculations. Cover with foil and let it rest for 15 to 20 minutes.
- If you wish to remove the meat from the oven (eg basting), unplug the meat probe from the socket but do not remove it from the meat. The display will show --. When you are ready to resume cooking, re-insert the probe plug into the socket and the display will alternate between the preset and current internal temperature of the meat.

### Important!

- *Use only the meat probe supplied with your oven, purchased from your Fisher & Paykel dealer or replaced under warranty by your nearest Fisher & Paykel Authorized Repairer.*
- *Hold the meat probe at the handle when inserting and removing it from food and the meat probe socket.*
- *Remember to remove the meat probe from the oven before you start a self-clean cycle.*
- *Do not store the probe in the oven.*
- *Only use the probe with fully defrosted food.*
- *Wash the meat probe in mild soapy water but do not immerse. It is NOT dishwasher safe.*

## 32 User preference settings

You can set your oven to:

- display the temperature in degrees Celsius or Fahrenheit
- give audio feedback (tones and beeps) or operate quietly
- display time as 12-hr or 24-hr
- operate with the display off
- have its lights on or off during cooking
- operate in Sabbath setting (see 'Sabbath setting' following).

Note: You cannot change the user preference settings when your oven is operating or set for automatic cooking.

### How to change preference settings

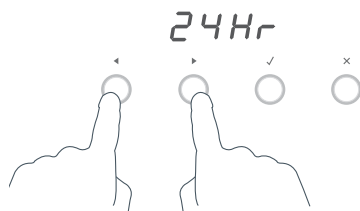

- 1 Check the function dial(s) are set to OFF and the display shows the time of day.
  - If you're unsure, press the cancel × button twice.

- 2 Press and hold the scroll ◀ ▶ buttons together for 3 seconds to enter the user preference menu.

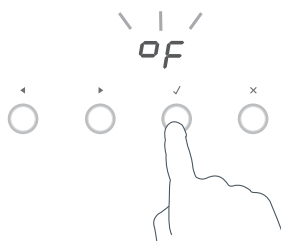
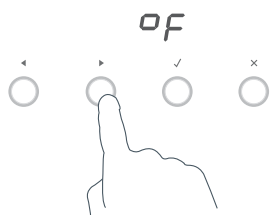

- 3 Press the right scroll ▶ button to scroll to the setting you want to change. Refer to the following table.

- 4 Press the select ✓ button to select the particular setting.
  - The display will flash.

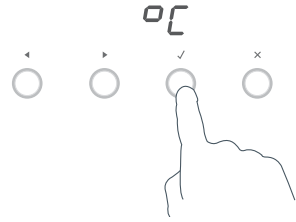
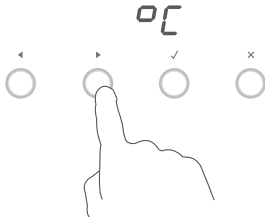

5 Press the right scroll ► button to scroll through the options for that particular setting. Refer to the table below.

6a Press the select ✓ button to save the new option .  
 6b For all options except 'Display off' : press the cancel × button to quit the user preference menu.

Setting	Default option	Alternative option(s)	
<b>TIME SCALE &amp; 'DISPLAY OFF' OPTION</b>  <i>Select between 24-hr or 12-hr clock display (and set the clock) or set 'Display off' option if you only need the basic functionalities of your oven.</i>	24 HR  24HR	12 HR  12HR	DISPLAY OFF **  OFF
<b>TEMPERATURE SCALE</b>  <i>Select between degrees Celsius or Fahrenheit.</i>	FAHRENHEIT  OF	CELSIUS  0C	
<b>AUDIO FEEDBACK</b>  <i>Turn the beeps and tones on or off.*</i>	BEEPS/TONES ON  bPon	BEEPS/TONES OFF  bPof	
<b>OVEN LIGHTS</b>  <i>Have the light off during cooking if you want to save power or want the food you cook to be a surprise for others!</i>	LIGHTS ON DURING COOKING  Lt on	LIGHTS OFF DURING COOKING  Lt of	
<b>SABBATH SETTING</b>	SABBATH OFF  Sb of	See 'Sabbath setting' for instructions.	

\* The timer tone and alert beeps will sound even if you save the **BEEPS/TONES OFF** option.  
 \*\* With this option saved, you can still use the oven, meat probe and timer. The display will remain otherwise unlit. You cannot set automatic cooking when this function has been selected. To quit this option and enable the display, press and hold the cancel × button.

## Sabbath setting

This setting is designed for religious faiths that observe a 'no work' requirement on the Sabbath.

### While your oven is in Sabbath setting

- The display, dial halos and indicators will be unlit, the buttons will be unresponsive.
- No tones or beeps will sound.
- No alert codes or temperature changes will be displayed.
- The oven lights will stay on. If you want the oven lights to be off during Sabbath setting, first select the 'Lights off' option as described in 'User preference settings', and only then set Sabbath setting.
- **Bake**  is the only function available in Sabbath setting.

### How to set Sabbath setting



- 1 Press and hold the scroll ◀ ▶ buttons together for 3 seconds to enter the user preference menu.

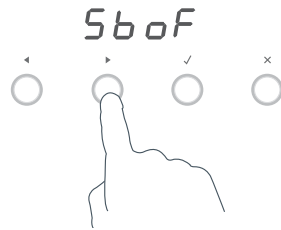

- 2a Press the right scroll ▶ button to scroll to the Sabbath setting.
- 2b Press the select button to select Sabbath setting.
  - The default option is 'Sabbath off'.



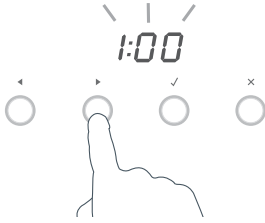

- 3 Press the select ✓ button to activate the option.
  - The display will flash 1:00.



- 4a Press the scroll ◀ ▶ buttons to set the time (hrs). You may set the time for up to 99 hours.

- 4b **Double oven models only:**  
Select the oven(s) you wish to use by pressing the UPPER or LOWER oven selector button

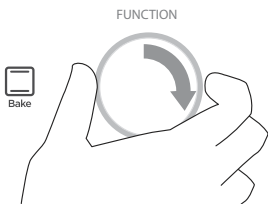

- 5 Turn the function dial to Bake.

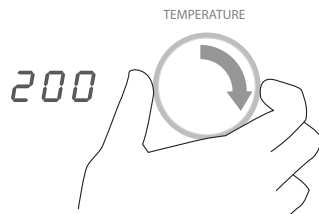

- 6a Adjust the temperature.

- 6b **Double oven models only:**  
If required, repeat the process for the second oven (by pressing UPPER or LOWER at step 4b)

- 7 Press the select ✓ button to activate.

The display, indicators and dial halos will be unlit and unresponsive, but the oven will be on until the time set elapses or you quit Sabbath setting.

## To quit Sabbath setting

Press and hold the cancel × button until the time of day appears in the display and the oven(s) turn off.

## Removing and replacing the sliding shelves and side racks

- 1 To remove a sliding shelf, grip it by its two front corners (making sure you are gripping the wire shelf and the sliding frame together), tilt upwards and pull it out of the oven.
- 2 To remove the side racks, gently push the retaining wire from underneath the lock stud, then swing the lowest edge of the side rack up and out towards the center of the oven until the rack is almost horizontal. The prongs at the top will slide out of the mounting slots.
- 3 To replace the side racks, hold them almost horizontally and locate the prongs into the small mounting slots at the top of the oven cavity. While you are doing this, support the rack with your hand from underneath, to ensure that both prongs perfectly locate into the mounting slots.
- 4 Lower the side racks carefully and gently place the retaining wire underneath the lock stud.

### ***Important!***

*Do not lower the side racks until the prongs are fully inserted into the slots so that you do not chip the enamel.*

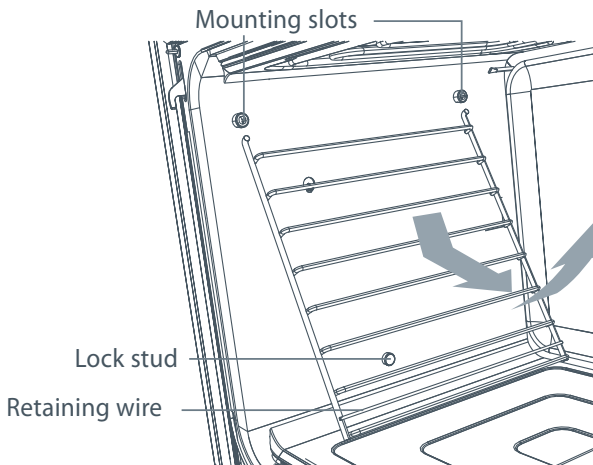

## Changing the oven light bulbs

The oven is illuminated by three 12 volt/20 watt halogen bulbs. These have a very long life, but if you should need to replace one, use only a replacement bulb purchased from your nearest Fisher & Paykel dealer and follow these steps:

- 1 Allow the oven to cool and then turn it off at the wall.
- 2 Take out the shelves and side racks (see 'Removing and replacing the sliding shelves and side racks') and use a small flat-head screwdriver to twist and lift the retainer clip at the top of the glass light cover while holding the glass to prevent it falling. The clip pivots counter-clockwise (see the diagram).
- 3 Carefully lift the glass cover out of the lower support and pull out the faulty bulb.
- 4 Holding the replacement bulb in a soft cloth or tissue (touching the bulb will reduce its life span), insert the new bulb.
- 5 Reposition the glass cover and twist the top clip back in place. The procedure is the same for the light in the roof of the oven cavity.

Note: oven bulb replacement is not covered by your warranty.

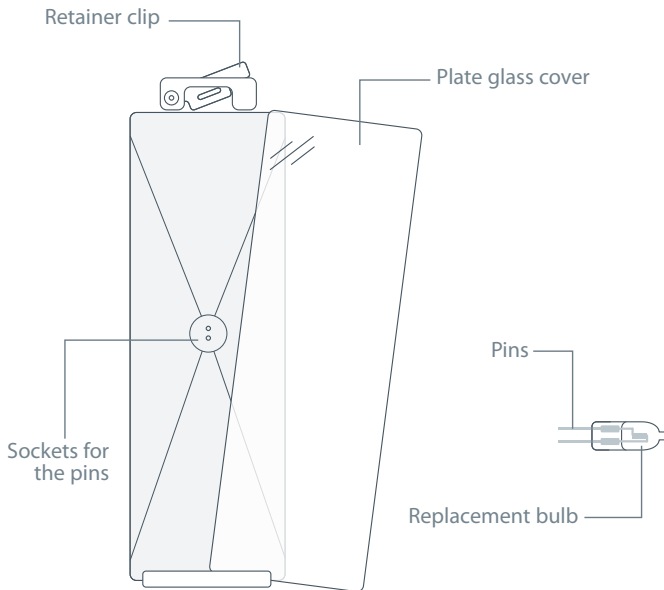

## Manual cleaning

## ALWAYS

- *Before any manual cleaning or maintenance, first wait for the oven to cool down to a safe temperature to touch, then turn its power supply off at the wall.*
- *Read these cleaning instructions and the 'Safety and warnings' section before you start cleaning your oven.*
- *To prevent soiling from becoming 'baked on' and stubborn, we recommend removing any easy-to-reach spills, food or grease stains from the oven cavity enamel after each use.*
- *Always clean the inner glass pane before starting a Self Clean cycle.*
- *Always remove oven shelves and side racks before starting a Self Clean cycle.*

## NEVER

- *Never use a steam cleaner.*
- *Never store flammable substances in the oven.*
- *Never use abrasive or harsh cleaners, cloths, scouring pads or steel wool. Some nylon scourers may also scratch. Check the label first.*
- *Never use oven cleaner in a pyrolytic oven.*
- *Never leave alkaline (salty spills) or acidic substances (such as lemon juice or vinegar) on the oven surfaces.*
- *Never use cleaning products with a chlorine or acidic base.*
- *Never spray detergent or liquid onto the buttons on the control panel. Liquid may seep behind the button and damage the electronics.*

## Manual cleaning

What?	How?	<i>Important!</i>
<b>Dials</b>	Clean with a solution of mild detergent and hot water, then wipe dry.	<i>Do not use stainless steel or oven cleaner on the dials, as doing so may damage their coating.</i>
<b>Stainless steel strip/handle on the front of the oven door</b>	<ul style="list-style-type: none"> <li>■ Clean with a solution of mild detergent and hot water, then wipe dry with a microfiber cloth.</li> <li>■ If necessary, use a suitable stainless steel cleaner and polish.</li> </ul>	<ul style="list-style-type: none"> <li>■ <i>Always read the label to make sure that your stainless steel cleaner does not contain chlorine compounds as these are corrosive and may damage the appearance of your oven.</i></li> <li>■ <i>Always rub the stainless steel in the direction of the grain.</i></li> </ul>
<b>Oven cavity</b>	<ul style="list-style-type: none"> <li>■ To clean light soiling off the enamelled surfaces:                             <ol style="list-style-type: none"> <li>1 Wipe with a damp cloth and a solution of hot water and mild detergent.</li> <li>2 Wipe dry with a soft cloth.</li> </ol> </li> <li>■ To clean stubborn, 'baked on' soiling or the whole oven cavity: use the Self Clean function. See 'Using the Self Clean function' for instructions.</li> </ul>	<ul style="list-style-type: none"> <li>■ <i>To prevent soiling from becoming 'baked on' and stubborn, we recommend removing any easy -to-reach spills, food or grease stains from the enamelled surfaces after each use. Doing so will reduce the need for using the Self Clean function frequently.</i></li> <li>■ <i>Always remove the side racks before a Self Clean cycle.</i></li> </ul>
<b>Telescopic sliding shelf supports</b>	Wipe with a damp cloth and mild detergent. Do not wipe off or wash away the white lubricating grease (visible when the slides are extended).	<i>Do not wash these in the dishwasher, immerse in soapy water, use oven cleaner on them or leave in the oven during a Self Clean cycle as doing so will remove the white lubricating grease and prevent the slides from running smoothly.</i>

## Manual cleaning

What?	How?	Important!
<b>Meat probe</b>	Clean with a solution of mild detergent and hot water, then wipe dry with a microfiber cloth.	<ul style="list-style-type: none"> <li>■ <i>Clean after every use to avoid contamination.</i></li> <li>■ <i>Do not wash in the dishwasher, immerse in soapy water, use oven cleaner or leave in the oven during a Self Clean cycle.</i></li> </ul>
<b>Broil rack</b> <b>Pan &amp; Grid</b> <b>Side racks</b> <b>Baking tray</b>	<ul style="list-style-type: none"> <li>■ Clean with a solution of mild detergent and hot water.</li> <li>■ Pre-soak stubborn burnt-on stains in a solution of dishwasher powder and hot water.</li> <li>■ Except for the baking tray, these parts are also dishwasher safe.</li> </ul>	<ul style="list-style-type: none"> <li>■ <i>Never leave any of these parts in the oven during a Self Clean cycle. They will become discolored or damaged.</i></li> </ul>
<b>Oven seal</b>	Do not clean this part.	<i>Do not rub, damage or remove the seal as it is important for ensuring your oven runs efficiently.</i>
<b>Oven vent louvres</b>	Wipe with a damp cloth.	<i>Take care not to let any liquid run down the louvres of the oven vent.</i>
<b>Oven door glass</b>	Use a mild solution of detergent and warm water; use a glass cleaner to remove smears.	<i>Do not use sharp metal scrapers or scourers on the glass as it may scratch the surface and cause the glass to shatter</i>

- During the pyrolytic Self Clean cycle the extremely high temperature burns off and breaks down grime and grease deposits. All that is left is a small amount of gray ash that you can easily remove.
- There is a choice of Self Clean cycles:
  - **Self Clean** (5 hours) (for normal soiling).
  - **Light Self Clean** (4 hours) (suitable for a light or localised soiling).

### ***Double oven models only:***

- Only one oven can be self-cleaned at a time.
- During the Self clean cycle you cannot use the other oven or set Automatic cooking.

## ***Important!***

- *You must clean the inside glass door panel BEFORE starting a self-clean cycle. Failure to do this may result in permanent staining or marking of the door glass.*
- *Do not use oven cleaners, any degreasing cleaners, or oven liners.*
- *Make sure you remove the side racks, oven shelves and trays and all other bakeware and utensils from the oven before starting a Self Clean cycle. If left in the oven, they will become permanently discolored or damaged; items made from combustible materials (eg wood, fabric, plastic) may even catch fire.*
- *Do not use your oven to clean miscellaneous parts.*
- *Make sure the room is well ventilated.*
- *Before starting a Self Clean cycle, make sure you move any pet birds to another, closed and well-ventilated room. Some pet birds are extremely sensitive to the fumes given off during a Self Clean cycle, and may die if left in the same room as the oven during such a cycle.*
- *During a Self Clean cycle, the oven reaches higher temperatures than it does for cooking. Under such conditions, the surfaces may get hotter than usual and children should be kept away.*
- *The oven door will be locked during the Self Clean cycle (approximately 5 hours).*
- *If there are cracks or flaws on any of the oven door glass panes, if the oven seal is damaged or worn, or if the door does not close properly, do not start a Self Clean cycle. Call your Authorized Repairer or Customer Care.*

## Using the Self Clean function

### To start a Self Clean cycle

- 1a Remove oven shelves, side racks and all other accessories, bakeware, and utensils.
- 1b Wipe up any spills. Failure to do so may discolor the oven surfaces.
- 1c Check the inner glass pane of the oven door. If it has soiling on it (eg stains from greasy splatter), you will need to clean it manually before starting a Self Clean cycle. For instructions, see 'Care and cleaning'.

### **Important!**

*If soiling is left on the glass, it will become burnt on during the Self Clean cycle, making it very difficult to remove.*

- 2a Close the oven door firmly.
- 2b **Double oven models only:**  
Select either the UPPER or LOWER oven.

### **Important!**

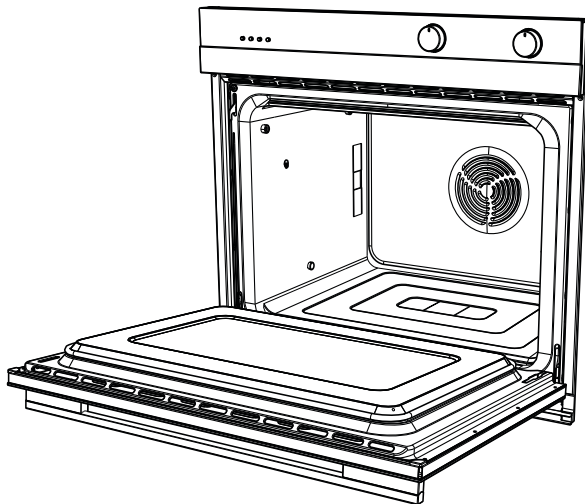

*Ensure the function dial for the other oven is turned to 'off'.*







- 3 Select the **Self Clean**  function.
  - The display will flash **0:00**





- 4 Press the right scroll  button once for the **Self Clean** cycle
  - the display will flash **5:00** (5 hours), **or**
 Press the right scroll  button a second time for the **Light Self Clean** cycle
  - the display will flash **4:00** (4 hours)



- The temperature indicator will be blank, as temperature cannot be adjusted.
- 5 Press the select  button to start the Self Clean cycle.
    - The time will start counting down.
    - For your safety, the oven door will automatically lock and remain locked during the cycle.
    - Note: if the select  button is not pressed within 15 seconds, the oven will automatically turn off. Start from step 3 again.
    - The display will show **DOOR** if the door is not shut properly. See 'Troubleshooting'.
 If the door is not shut properly within 30 seconds, the oven will automatically turn off.



## During the Self Clean cycle

- the temperature and function halos will remain off.
- the **Self Clean**  function will be lit.
- the display will countdown the time remaining.
- the cancel  button will glow red  
(excluding OB30SC model).

## When a Self Clean cycle has finished

The oven will:

- emit a long tone
- automatically turn off
- automatically unlock the door.

In a few seconds, the display will show the time of day.

You need to:

- 1 wait for the oven to cool down completely
- 2 remove the gray ash with a small brush or damp cloth
- 3 wipe out the oven with a clean damp cloth
- 4 dry with a clean lint-free cloth
- 5 replace the side racks and shelves.

## To cancel a Self Clean cycle

### **Important!**

- *A Self Clean cycle can be canceled at any time by pressing the cancel × button.*
- *The door will not unlock until the oven has cooled to a safe temperature. This will take 40 minutes. Do NOT turn off the mains power supply to the oven (wall switch). Turning off the power while the oven is too hot may damage the oven and its surrounding cabinetry.*

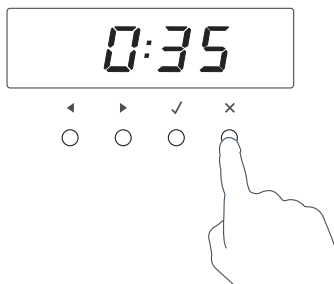

To cancel a Self Clean cycle, press the cancel × button.

- If the oven needs to cool down, the **Self Clean**  function indicator will stay lit, the display will show the remaining cool-down time, the temperature indicator will show cascading bars  and the door will remain locked.

### **Double oven models only:**

You will not be able to use either oven until the oven undergoing the self clean cycle has cooled down.





- When it has cooled down, the oven will turn off, the door will unlock, a long tone will sound and the display will show the time of day.
- We do not recommend cancelling a Self Clean cycle and then immediately starting one again.

## Troubleshooting chart



If there is a problem, check the chart below to see if you can fix it. If the problem cannot be fixed or persists, call your Authorized Repairer or Customer Care.

Problem	Possible causes	What to do
<i>General</i>		
<b>The oven does not work.</b>	No power.	Check that the mains power supply (wall switch) is turned on, the fuse has not tripped and there is no power outage in your area.
<b>The oven does not work but the display is lit.</b>	The oven is set for automatic cooking.	See 'Automatic cooking' for instructions.
<b>The lights do not come on when I open the oven door.</b>	The oven light bulb(s) have blown.	Replace the light bulb(s). See 'Care and cleaning' for instructions.
	The oven is in Sabbath setting and the 'Light off' option has been saved.	To quit Sabbath setting, press and hold the cancel × button. See 'User preference settings' for instructions on changing the 'Light off' option.
<b>Dials and buttons are unresponsive.</b>	The control panel is locked.	Press and hold the select ✓ or cancel × button to unlock the control panel.
<b>The oven is not heating.</b>	The door is not properly closed or it is opened too frequently during cooking.	The heating elements are disabled while the door is open. Make sure the door is properly closed and avoid opening it frequently during cooking.
<b>A glass pane in the oven door has cracked, chipped, or shattered.</b>	Incorrect cleaning or heavy object dropped on open door.	You must NOT use the oven. Call your Authorized Repairer or Customer Care.
<b>The display shows DOOR</b>	The door is open during cooking (some functions only).	Ensure the door is shut fully.

Problem	Possible causes	What to do
<i>General</i>		
<b>I can feel hot air blowing out of the vents after I have turned the oven off.</b>	This is normal.	For safety reasons the cooling fans will continue to run even when you have turned the function dial to 'Off'. The fans will switch off automatically when the oven has cooled.
<b>The oven fan comes on when I select a function that does not use a fan (eg Bake or Classic Bake)</b>	This is normal. The fan comes on while the oven is preheating. It may turn off when the oven has reached the set temperature.	Wait until a long tone sounds and the temperature dial halo turns white: the oven will then be ready to use.
<b>The oven has reached the set temperature but the temperature dial halo is still red (indicating that the oven is not ready to use).</b>	This is normal: when heating up from cold, your oven is designed to initially heat to a temperature somewhat higher than what you have set. This is to provide optimal baking conditions right from the start.	Wait until a long tone sounds and the temperature dial halo turns white: the oven will then be ready to use.
<b>The oven is heating but the display is dark.</b>	The oven is set to 'Display off' option.	To quit the 'Display off' option, press and hold the cancel × button until the display shows the time of day.
	The oven is in Sabbath setting.	To quit Sabbath setting, press and hold the cancel × button until the display shows the time of day.
<b>The oven cancels automatic cooking when I try to adjust the clock setting.</b>	The oven was set for automatic cooking when you were trying to adjust the clock setting.	You can only adjust the clock setting while the oven is not set for automatic cooking.
<b>The oven sounds a tone when I try to turn the temperature dial below a certain temperature.</b>	This is normal: for food safety reasons, the oven functions have factory-set minimum temperature settings.	The temperature dial itself cannot be 'turned off'. Selecting <b>Off</b>  with the function dial will turn the oven off.
<b>The temperature dial halo never turns white when I use <i>Broil</i>  or <i>Maxi Broil</i> .</b>	This is normal: the halo stays red to indicate that the broil element provides instant radiant heat.	

Problem	Possible causes	What to do
<i>General</i>		
<b>The displays work, and the function and temperature dials halos come on but the oven does not heat up.</b>	The oven is in 'Demo' mode.	Call Customer Care.
<b>The automatic cooking indicators do not light up</b>	You are trying to use a meat probe and automatic cooking.	You cannot use the meat probe at the same time as using automatic cooking. See 'Using the Meat Probe'
<b>OR</b>		
<b>The meat probe indicator does not light up.</b>		
<b>I cannot start the Sabbath setting.</b>	You have not selected the <i>Bake</i>  function.	You must select the <i>Bake</i>  function when using the Sabbath setting.
<b>The function dial is flashing; or the oven turns off.</b>		
<b>Double ovens only:</b>	You have not selected an oven cavity.	YOU must select an oven (UPPER or LOWER) before you can set Automatic cooking functions.
<b>The minute minder shows , the oven sounds a tone and the function dial halo flashes when I press the right scroll ► button.</b>		
<b>During <i>Maxi Broil</i>  the oven is louder than usual.</b>	This is normal: the oven's cooling fans are operating at their highest speed.	

Problem	Possible causes	What to do
<i>Self Clean function</i>		
<b>During a Self Clean cycle, the oven is louder than usual.</b>	This is normal: the oven's cooling fans operate at their highest speed.	
<b>The display shows - -</b>	The meat probe mode has been selected but the meat probe is not plugged in to the socket.	Ensure the meat probe is plugged into the socket. Cancel meat probe by pressing the cancel x button.
<b>The display shows DOOR.</b>	The door has not been properly closed.	Make sure you close the door properly.
<b>The display shows  but the oven door will not open.</b>	The oven door is locked because the oven is still too hot to be used for cooking.	Wait until the Self Clean cycle has finished. If you canceled a Self Clean cycle which was already underway, the oven still needs to cool down before it can be used. The oven door will automatically unlock.
<b>At a point during a Self Clean cycle, the function dial halo goes out and the temperature indicator starts displaying cascading bars .</b>	This is normal: the oven is in the last phase of the Self Clean cycle, cooling down.	Wait until the Self Clean cycle has finished. A long tone will sound and the oven door will automatically unlock when the oven is ready to use.
<i>Double oven models only:</i> <b>I cannot select the Self clean function.</b>	One oven is already turned on or set for automatic cooking.	You cannot start a Self Clean cycle when one oven already has a function selected. Turn the function dial to <b>Off</b>  and try again.

Problem	Possible causes	What to do
<i>Self Clean function</i>		
<p><b>I have canceled a Self Clean cycle but cannot use the oven:</b></p> <ul style="list-style-type: none"> <li>■ <b>the oven door will not open</b></li> <li>■ <b>the display is still counting down minutes or showing </b></li> <li>■ <b>the Self Clean  function indicator is still lit</b></li> <li>■ <b>the temperature indicator shows cascading bars </b></li> <li>■ <b>the dials and buttons are unresponsive.</b></li> </ul>	<p>This is normal: if the function dial halo is unlit, you have successfully canceled the Self Clean cycle. However, the oven is still too hot to be used for cooking and needs to cool down.</p>	<p>Wait until the cool-down phase has finished. A long tone will sound and the oven door will automatically unlock when the oven is ready to use. Note: depending on when the Self Clean cycle was canceled, the cool-down phase may take up to 40 minutes.</p>
<p><b>The oven is beeping and the display shows <i>R2</i> or <i>R3</i>.</b></p>	<p>See section 'Alert codes' for instructions.</p>	
<p><b>There is a power cut during a Self Clean cycle.</b></p>	<p>Power cut.</p>	<p>The door will remain locked. Once the power is turned back on, the door will remain locked until the oven has cooled to a safe temperature.</p>

If there is a problem, the oven will:

- automatically suspend all oven functions
- beep five times
- display an alert code.

## ***Important!***

*Do not turn off the mains power supply to the oven (wall switch) if you get an alert code, unless the instructions in the chart following specifically instruct you to. There are cooling fans within the oven which are needed to cool the oven's components. Turning off the power while the oven is too hot may damage the oven and its surrounding cabinetry.*

## **What to do if an alert code is displayed**

- 1 If the beeping hasn't stopped already, press any button to stop it.
- 2 Make a note of the alert code displayed. You may need this information.
- 3 Check the chart following to see if you can fix the problem yourself and follow the instructions.
- 4 *If you can fix the problem* and the alert code does not reappear, you can keep using your oven.

### **OR**

*If you can't fix the problem* yourself or the alert code reappears and the problem persists: wait until the cooling fans have stopped and the oven has completely cooled down, then turn the power to the oven off at the wall and call your Authorized Repairer or Customer Care with the alert code information.



Alert code	Possible causes	What to do
<i>A1</i>	The oven has overheated.	<ol style="list-style-type: none"><li>1 Allow the oven to cool down.</li><li>2 Once the oven has cooled down and the door has unlocked, the alert code will disappear. You can now use the oven again.</li></ol>
<i>A2</i>	Door lock error: the door cannot be locked after you have started a Self Clean cycle.	<ol style="list-style-type: none"><li>1 Turn the power to the oven off at the wall and on again.</li><li>2 Wait approximately 10 seconds. This is to allow the door lock to return to its initial position.</li><li>3 Set the clock. See 'Setting the clock and first use' for instructions.</li><li>4 Try starting a Self Clean cycle again, making sure that you close the door firmly. See 'Using the Self Clean function'.</li></ol>
<i>A3</i>	Door lock error: the door cannot be unlocked after a Self Clean cycle has finished.	<ol style="list-style-type: none"><li>1 Turn the power to the oven off at the wall and on again.</li><li>2 Try pressing on the oven door to help the door lock disengage.</li><li>3 If this doesn't help and the alert code reappears, call your Authorized Repairer or Customer Care.</li></ol>
<i>F</i> + number	Technical fault.	<ol style="list-style-type: none"><li>1 Note down the alert code.</li><li>2 Wait until the cooling fans have stopped and the oven has completely cooled down.</li><li>3 Turn the power to the oven off at the wall.</li><li>4 Call your Authorized Repairer or Customer Care with the alert code information.</li></ol>

**Before you call for service or assistance ...**

Check the things you can do yourself. Refer to the installation instructions and your user guide and check that:

- 1 your product is correctly installed.
- 2 you are familiar with its normal operation.

If after checking these points you still need assistance or parts, please refer to the Service & Warranty book for warranty details and your nearest Authorized Repairer, or contact us through [www.fisherpaykel.com](http://www.fisherpaykel.com)

**Product details**

Fisher & Paykel Ltd

**Model** ..... **Serial no.** .....

**Date of purchase** ..... **Purchaser** .....

**Dealer** ..... **Suburb** .....

**Town** ..... **Country** .....



[www.fisherpaykel.com](http://www.fisherpaykel.com)

***Fisher & Paykel***

Copyright © Fisher & Paykel 2014. All rights reserved.

The product specifications in this booklet apply to the specific products and models described at the date of issue. Under our policy of continuous product improvement, these specifications may change at any time. You should therefore check with your Dealer to ensure this booklet correctly describes the product currently available.