

**FOTILE**

**RANGE HOOD**

User Manual | EMS9016/EMS9017/EMS9018

Please read carefully about the user manual before using the product.  
And keep it well after reading, for future reference.

Honorable guest, thank you for your choice of FOTILE products. Please read through the manual to be familiar with the correct operation norms and enjoy the cooking.

FOTILE promise is making our home better. It is our duty to let you satisfy with FOTILE products. Please read the user manual carefully before using it, and operate it complying with the manual requests. The manual description is important to keep the product a good working condition. And you will lose the free warranty right if the product is failed to use due to your improper use, thus any direct or indirect free warranty certificate will be rejected by FOTILE authorized service center. Meanwhile, we suggest you contact FOTILE service center when the product need to be repaired no matter within or exceed the warranty period. FOTILE star-level service goal is to make customers fully satisfied by our tireless efforts.

## CONTENTS

Warning and Safety Instructions .....	1
Usage .....	3
Operation Instruction .....	4
Cleaning and Maintenance .....	9
Normal Malfunction and Trouble Shooting .....	10
Installation .....	11
Packing List .....	11
Installation Methods .....	11
Installation Suggestions .....	12
Installation Steps .....	15
Debugging .....	16
Main Technical Specifications .....	17
Component Name Diagram .....	17

## READ AND SAVE THESE INSTRUCTION

### Warning and Safety Instructions

- ◇ To avoid any accidental risks or damages to the range hood, please read this user's manual carefully before initial installation and use.
- ◇ Make sure that the actual voltage and frequency are accorded with the ones clarified in this user's manual to avoid any possible damages to the range hood.
- ◇ The range hood is for residential use only.
- ◇ Caution: For general ventilating use only. Do not use to exhaust hazardous or explosive materials and vapors.
- ◇ Unplug or disconnect the appliance from the power supply before servicing.

#### ■ Environmental Protection

1. Packing materials like absorption film, polystyrene and plastics may cause suffocation, so please keep them away from the reach of infants and children.
2. Dispose the packing materials properly.
3. The replaced appliance should be sent to the local reclamation depot or recycling center. Keep children away from those places to ensure their safety. The electric wire of the appliance should be cut off to avoid misuse.

#### ■ Mechanical Safety

1. Please use standard accessories provided by our company to ensure safe installation. (Make sure to use the expansion pipe and expansion bolt provided by our company, in case the range hood falls down accidentally); The hole drilled in the wall should precisely match the size of the expansion pipe, otherwise, the range hood may loose and fall down.
2. The wall should be strong enough to support the range hood. As for hollow wall or hollow plate, the thickness of its solid part should be no less than 1<sup>1</sup>/<sub>8</sub> inch. As for concrete wall, the installation can be directly operated. The range hood should be firmly fixed on the wall.
3. When drilling on the roof or ceiling, please make sure not to damage the electric lines as well as any other hidden devices.
4. When moving the range hood for installing, cleaning or repairing, please make sure to wear protective gloves to prevent your hands as the edge of the range hood.
5. The appliance is not intended for use by hurtby the (including children) with reduced physical sensory or mental capabilities, or lack of experience and knowledge, unless they have been given supervision or instruction concerning use of the appliance by a person responsible for their safety.
6. Children should be supervised to ensure that they do not play with the appliance.

#### ■ Electrical Safety and Fire Prevention

1. The range hood should be connected to a standard power socket with safe grounding. The midway connection, prolonged electric line or multi-socket wiring may cause electric shock, overheating and even fire. The wiring task should only be carried out by a professional electrician in accordance with current national or local electric safety regulations. Power off before wiring and make sure proper measures have been taken to avoid unexpected connection.
2. If the supply cord is damaged, it must be replaced by a special cord or assembly available from the manufacturer or its service agent.
3. All electrical parts including motor, switch and connector assembly, etc. should be strictly prevented from water. Never rinse your range hood directly with water or high-pressure steam. Never use the range hood when it is wetted to prevent electric shock.
4. Never touch the power plug, power switch or other electric parts with wet hand, otherwise, you may get an electric shock.
5. Never discharge the exhaust of range hood through the hot flue which is used to release waste smoke arising from coal and gas or other fuels.
6. When the cooking utensil catches fire, switch off the range hood immediately. Effective extinguishing measures must be taken at once, such as covering the open flame with metal cover, turning off the master gas valve and keeping flammable substance from the open flame etc.

7. Never use an open flame under the range hood. To avoid the danger of fire, do not cook or grill over an open flame under the range hood. When switched on, the range hood could draw flames into the filter. Fat partical drawn into the range hood present a fire hazard.
8. All exhaust pipes, flues and devices should be non-flammable. Never cover the range hood with flammable plastic film or paper.
9. The range hood should be fixed on the wall above the cook top. Keep a height of 25<sup>9</sup>/<sub>16</sub>~29<sup>9</sup>/<sub>16</sub> inch between the bottom of the range hood and the surface of the cook top. The working temperature for the range hood should not exceed 104°F.
10. After the appliance fixed, the plug should be accessible.
11. Do not dispose of electrical appliances as unsorted municipal waste, use separate collection facilities. Contact you local government for information regarding the collection systems available. If electrical appliances are disposed of in landfills or dumps, hazardous substances can leak into the groundwater and get into the food chain, damaging your health and well-being.
12. There is fire risk if cleaning is not carried out in accordance with the instructions.

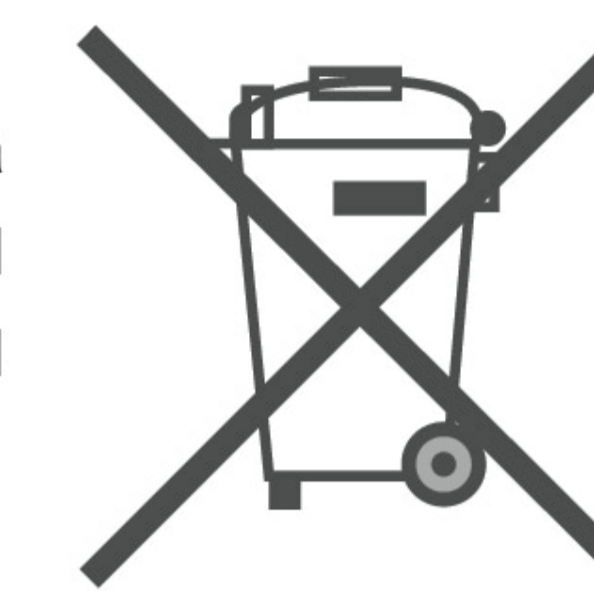

#### ■ Danger of Toxic Fumes

1. Great care should be taken when using the gas cook top which may cause carbon monoxide poison. Keep the room well ventilated.
2. When the range hood is under exhaust mode, make sure to install the damper along with the range hood.
3. Clean the metal filter according to actual conditions.

#### ■ Suggestion and Description

1. Warranty service is not provided based on the following situations:
  - 1) Failing to show invoice issued by authorized agents.
  - 2) Damages of the parts due to the abused and wrong installation, improper use, improper location, carelessness or other factors.
  - 3) Repair and maintenance without the permission of FOTILE authorized agents.
  - 4) Other situations that can't be controlled by FOTILE authorized agents.

In above case, FOTILE will be released from any responsibilities for the loss of personal property, personal injury directly or indirectly caused by the product.
2. Never expose the range hood when your kitchen is being decorated. The construction material, dust, lacquer, paintings as well as their released gases may corrupt the surface of the range hood and make it tarnished. Therefore, please install the range hood after decoration.
3. Please clean the surface of range hood with neutral detergent and soft cloth. Wring out the cloth when cleaning the switch and lamps.
4. Make sure to keep the appliance horizontally. Over long or more bends of exhaust pipe may impair air function, and more relative operation noise will occur.
5. In case any malfunctions occur, please power off the range hood at once, and call our authorized dealers or distributors for help.
6. This manual contains the information updated till the time when it is printed. We keen on technical innovation, we will reserve the rights to improve or modify the product and user's manual without any prior notices. Some of the illustrations in this manual are for reference purpose only, and subject to the actual products if there are any differences.

#### WARNING – TO REDUCE THE RISK OF A RANGE TOP GREASE FIRE:

- a) Never leave surface units unattended at high settings. Boilovers cause smoking and greasy spillovers that may ignite. Heat oils slowly on low or medium settings.

- b) Always turn hood ON when cooking at high heat or when flambeing food (i.e. Crepes Suzette, Cherries Jubilee, Peppercorn Beef Flambe’).
- c) Clean ventilating fans frequently. Grease should not be allowed to accumulate on fan or filter.
- d) Use proper pan size. Always use cookware appropriate for the size of the surface element.

**WARNING – TO REDUCE THE RISK OF INJURY TO PERSONS IN THE EVENT OF A RANGE TOP GREASE FIRE, OBSERVE THE FOLLOWING:**

- a) SMOTHER FLAMES with a close-fitting lid, cookie sheet, or metal tray, then turn off the burner. BE CAREFUL TO PREVENT BURNS. If the flames do not go out immediately, EVACUATE AND CALL THE FIRE DEPARTMENT.
- b) NEVER PICK UP A FLAMING PAN – You may be burned.
- c) DO NOT USE WATER, including wet dishcloths or towels – a violent steam explosion will result.
- d) Use an extinguisher ONLY if:
  - 1) You know you have a Class ABC extinguisher, and you already know how to operate it.
  - 2) The fire is small and contained in the area where it started.
  - 3) The fire department is being called.
  - 4) You can fight the fire with your back to an exit.

**GROUNDING INSTRUCTIONS**

This appliance must be grounded. In the event of an electrical short circuit, grounding reduces the risk of electric shock by providing an escape wire for the electric current. This appliance is equipped with a cord having a grounding wire with a grounding plug. The plug must be plugged into an outlet that is properly installed and grounded.

**WARNING – Improper grounding can result in a risk of electric shock.**

Consult a qualified electrician if the grounding instructions are not completely understood, or if doubt exists as to whether the appliance is properly grounded.

Do not use an extension cord. If the power supply cord is too short, have a qualified electrician install an outlet near the appliance.

**TO REDUCE THE RISK OF FIRE, USE ONLY METAL DUCTWORK.**

**Usage**

- Firstly, let's be familiar with the range hood control interface.

Control panel of EMS9016

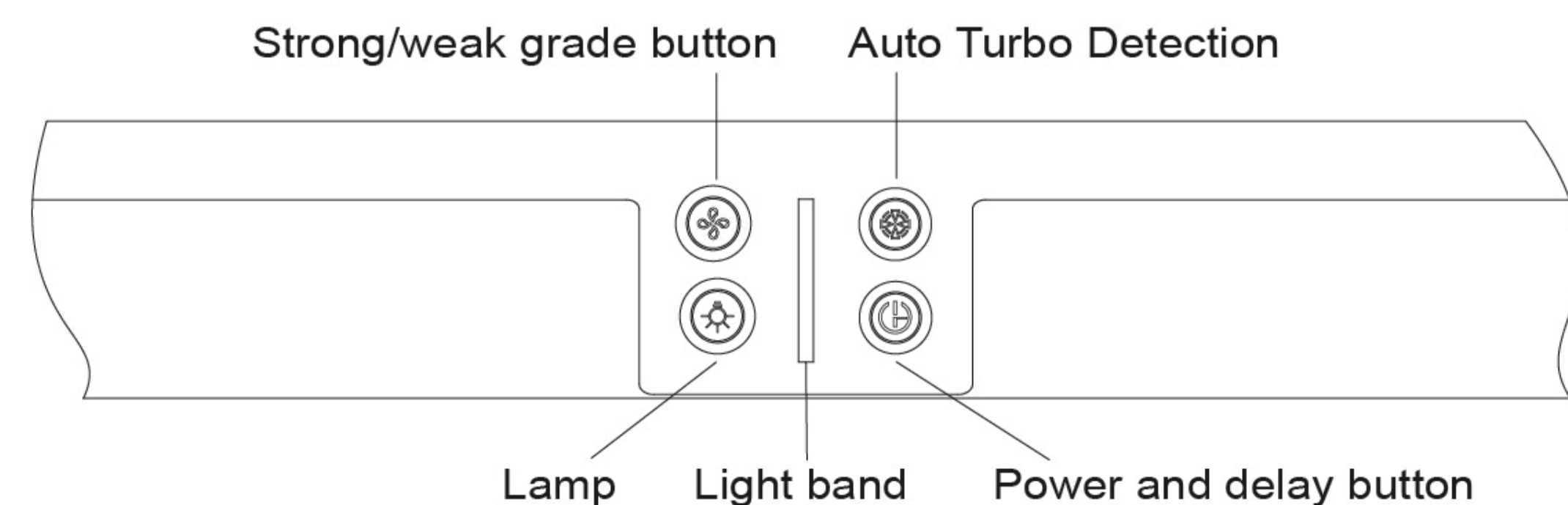

Control panel of EMS9017

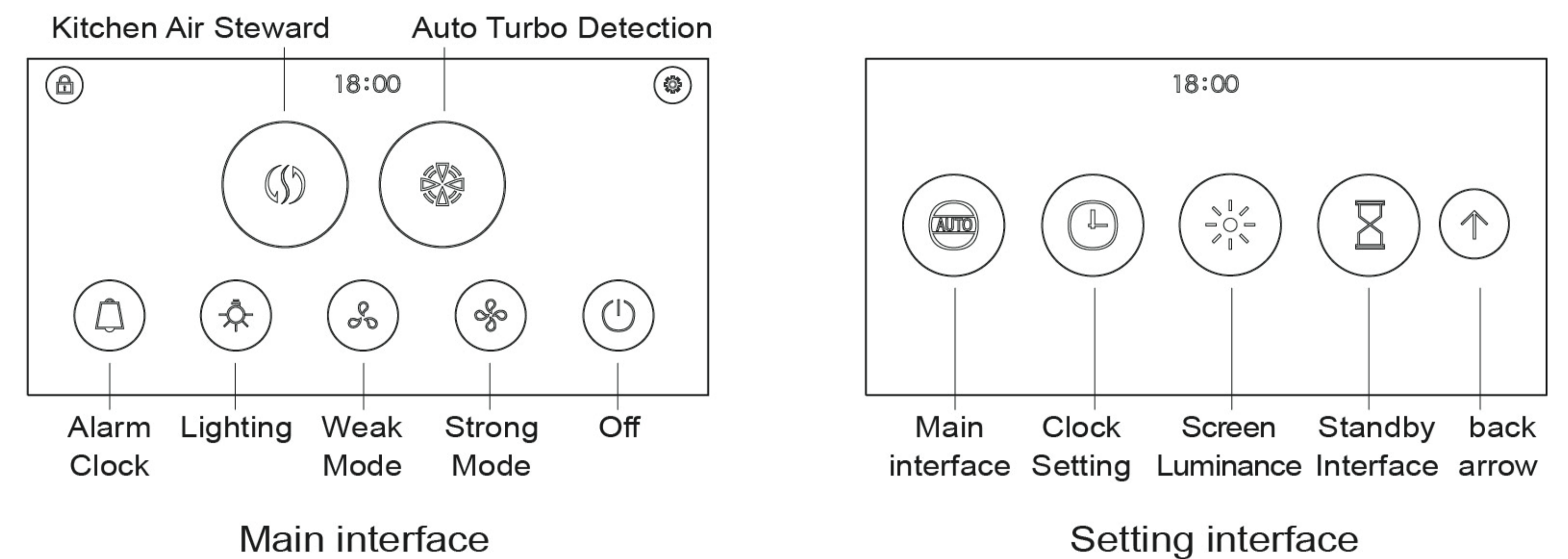

Control panel of EMS9018

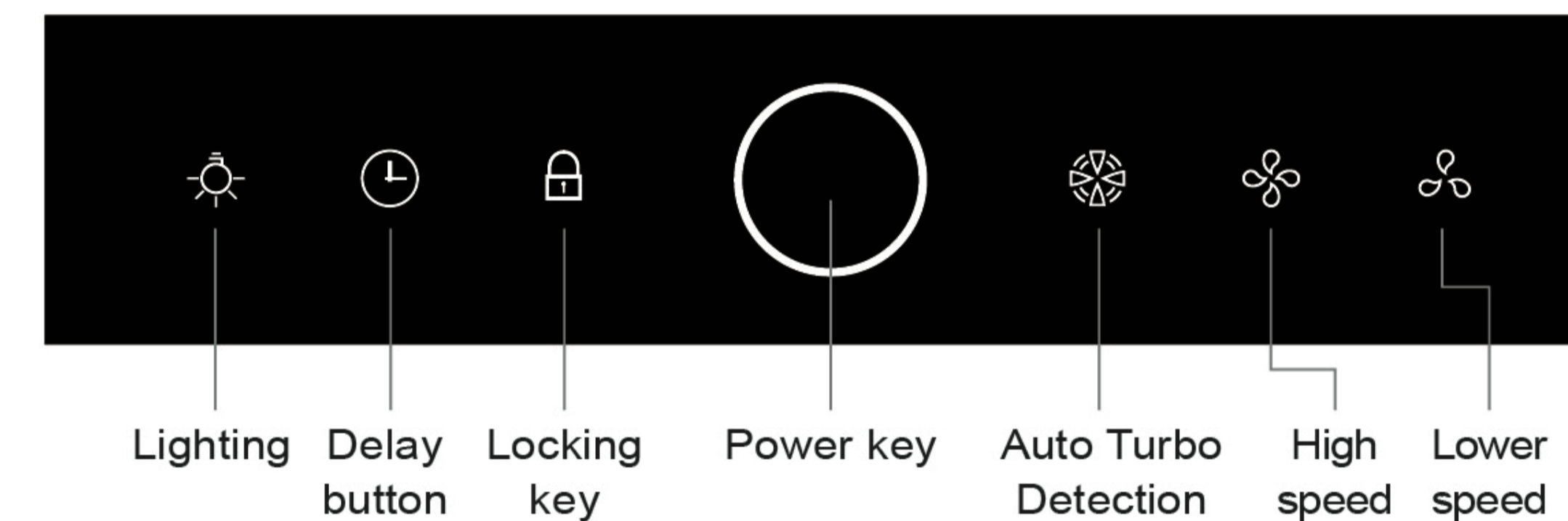

**Operation Instruction**

**EMS9016**

- Turn On/Off, Time delay Function

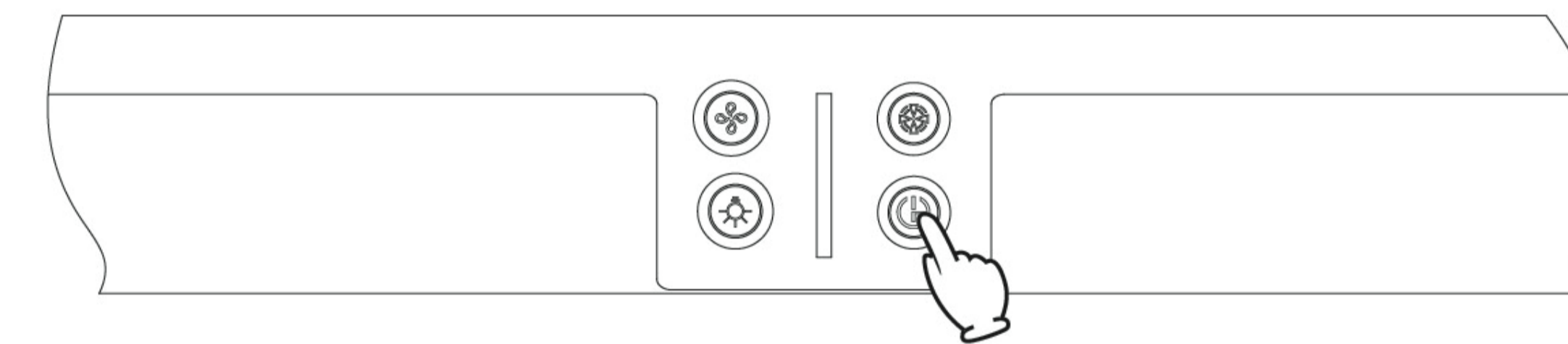





When is touched, the range hood will standby for operation. If there is no operation on stand it will be turned off automatically.

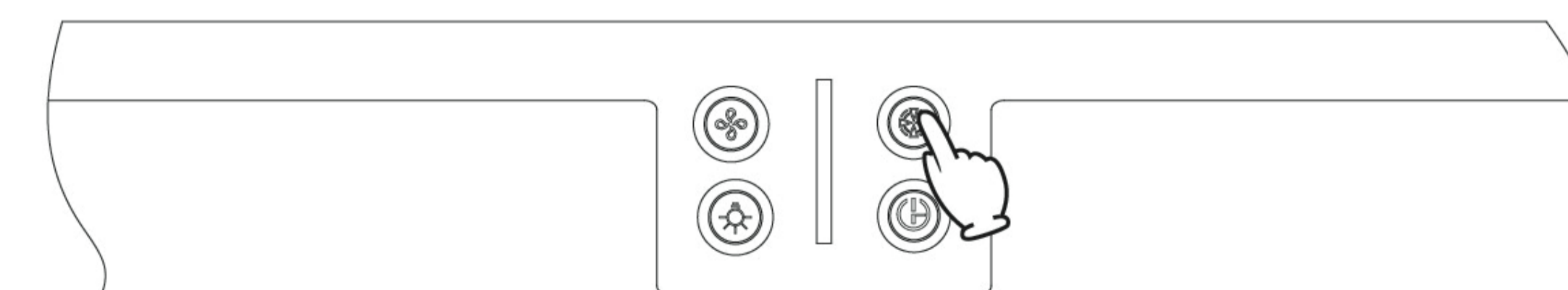

When is touched, the rang hood is working on or on standby, the hood will also be turned off automatically after 2 minutes, and the light indicator will be flashing.

- Suction Function

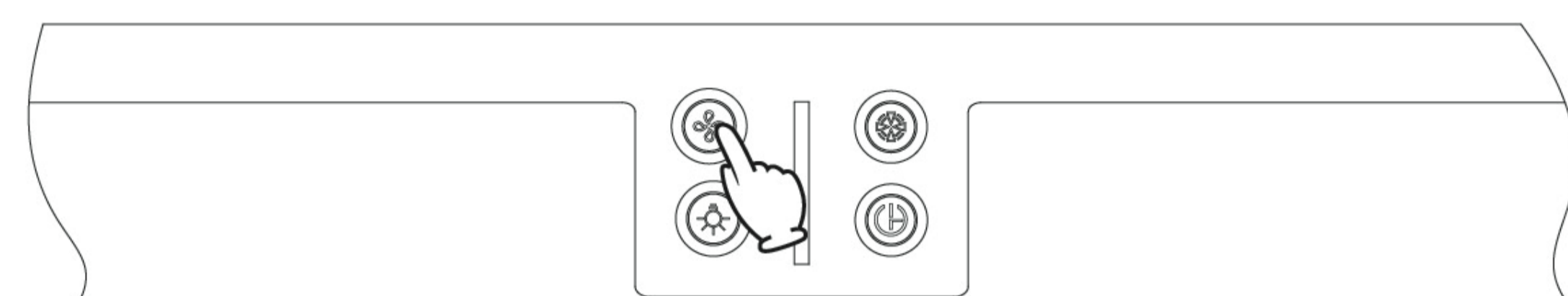

When  is touched under the standby or operational mode, all indicator lighting are light; after the range hood maintaining for 5 seconds under the Auto turbo detection mode, and then returns to the normal mode and operate at the strong grade, the indicator lighting of  button is semi-lighting, and the flue resistance shall be checked automatically, when the flue resistance is larger than the setting value, the motor turns to the Auto turbo detection mode to run automatically, at this time, the indicator lighting of  button is fully-lighting; if the flue resistance restores to the normal condition, then after 30 seconds, it returns to the normal mode to run at the strong grade. If you want to close such function, press .

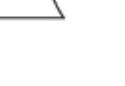

Touch the button , the motor shall be started; the indicator lighting of  button is fully-lighting, and the range hood is running at the strong grade; then touch the button again, the indicator lighting of  button is semi-lighting, the range hood is running at weak grade, touch again, the function is turned off.

■ Illumination Function

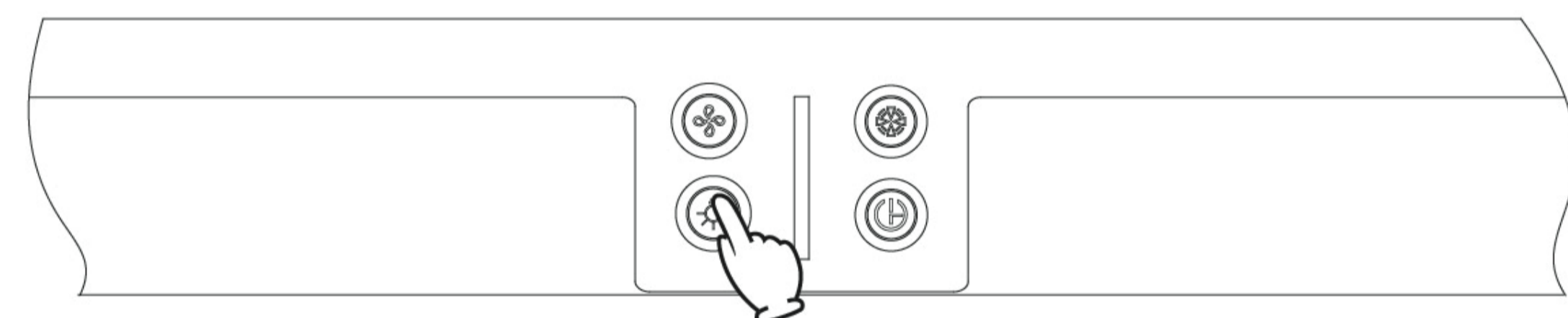

Press the “”button, the light is turned on, and press the button again, the light is off.

EMS9017

■ Turn On/Off, Screenlock Function

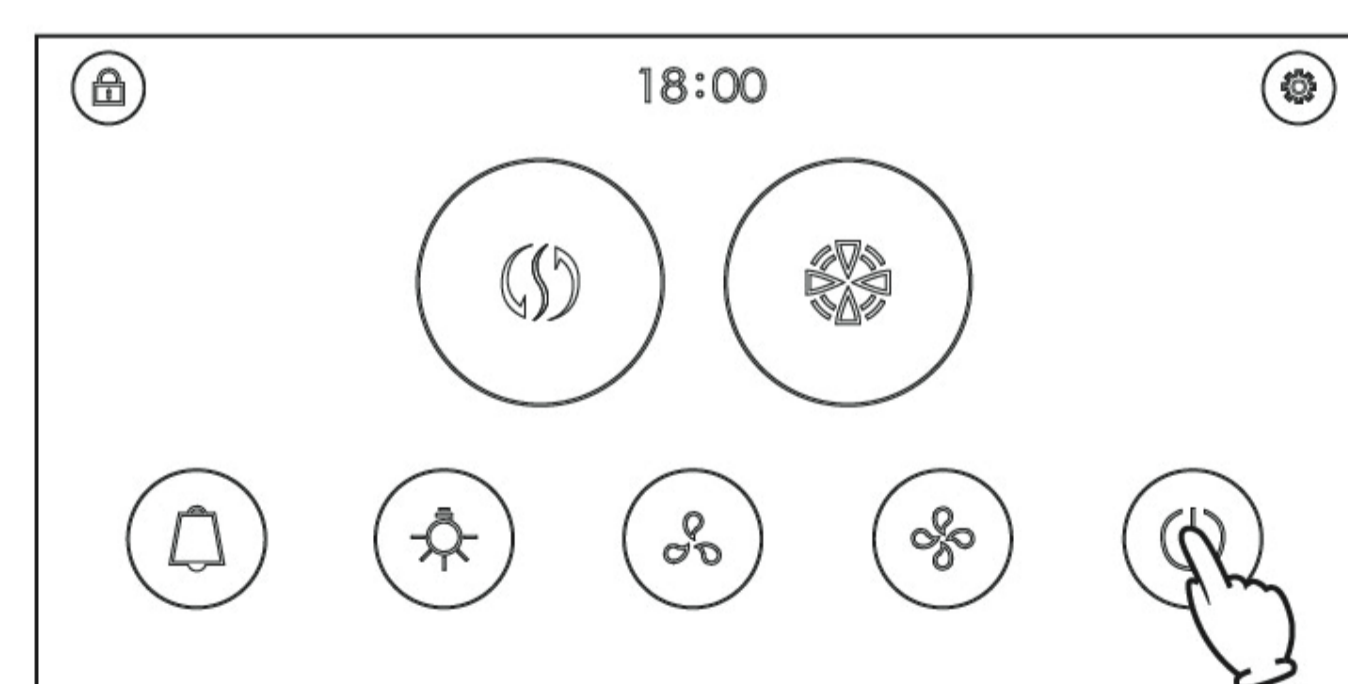

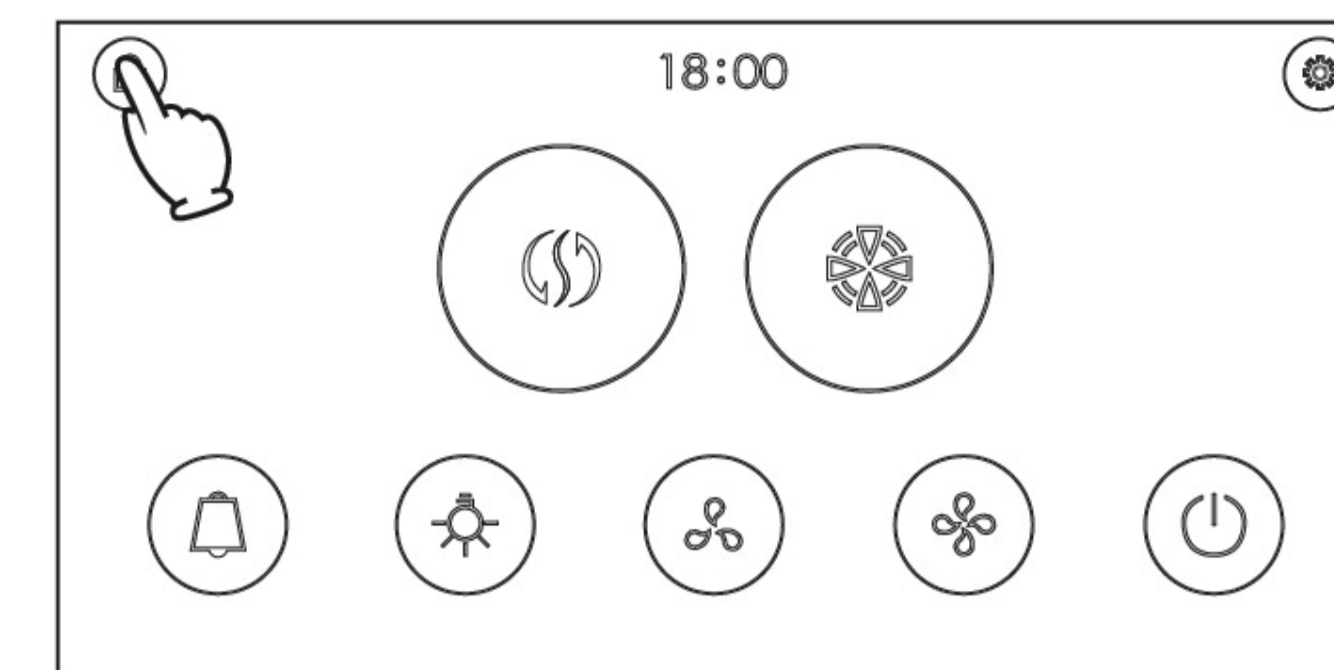

Press  key and the device is turned off. (If “delay shutdown” is set, this function will be implemented.) All functions are immediately turned off to enter the black screen or clock screensaver interface. Click anywhere on the screen again to enter the main interface.



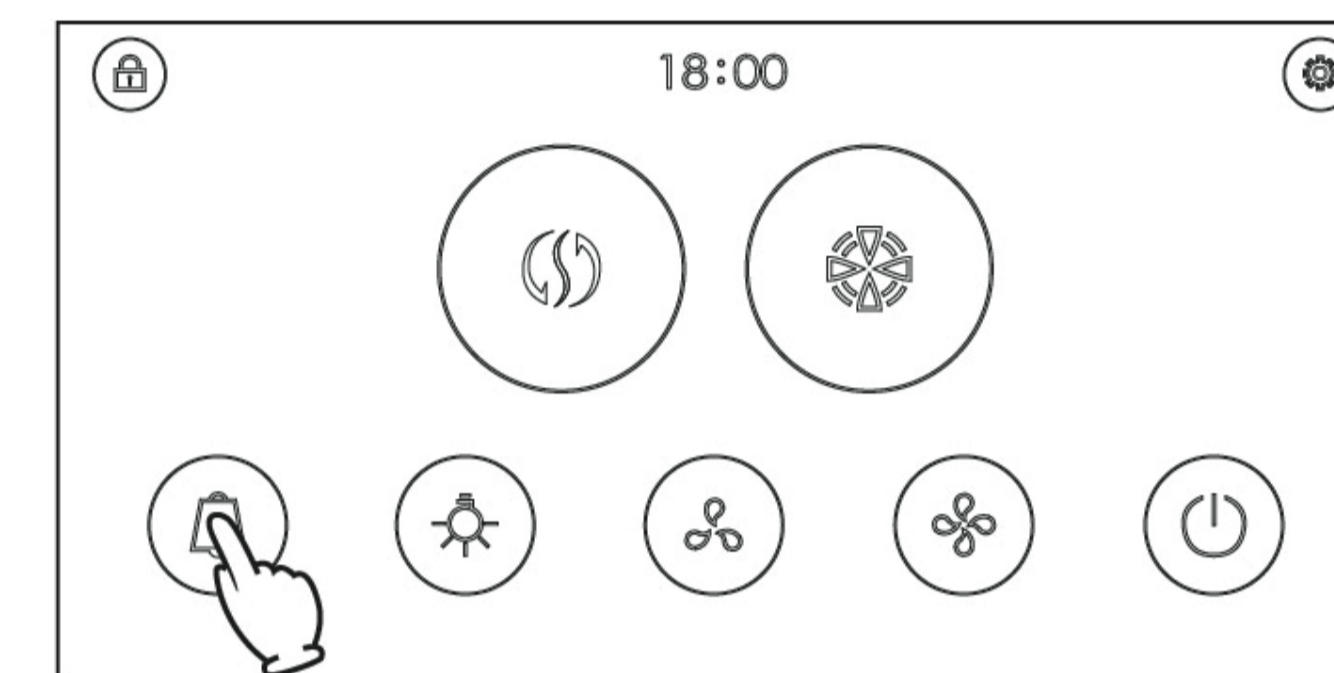

Press  key to enter the panel lock interface. Slide to unlock.

■ Suction Function



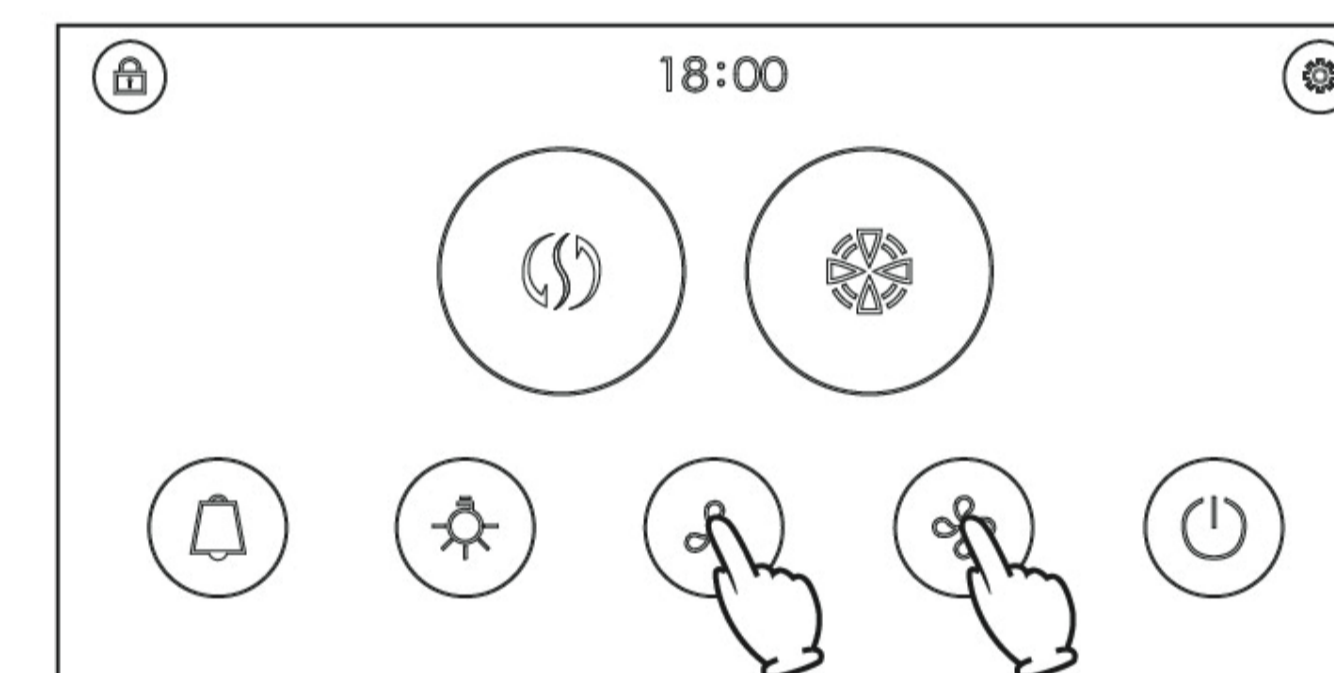



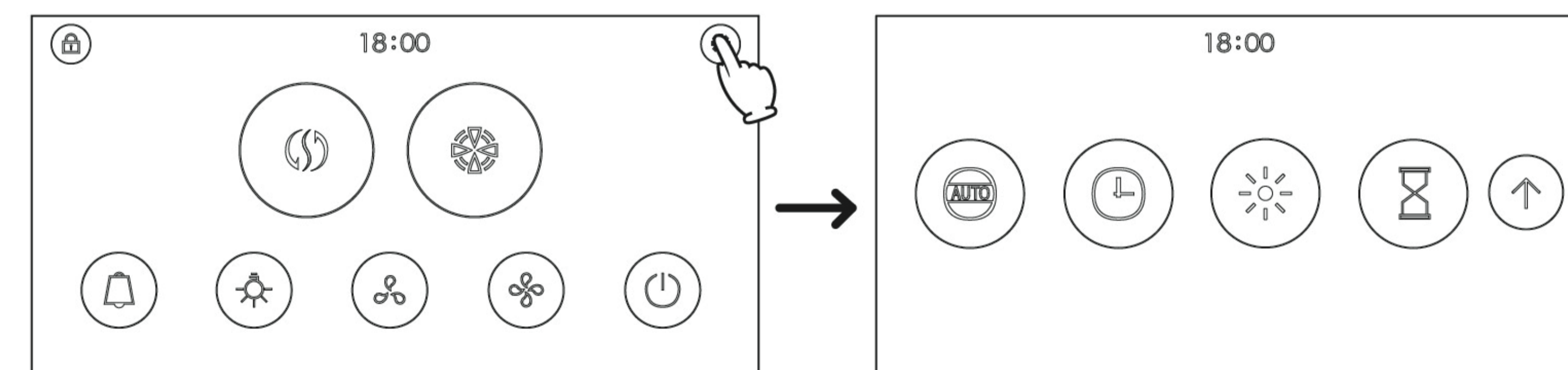

Press  key to enter the alarm clock setting interface and set the countdown alarm clock. Prompt tone will be heard when time is up. The prompt tone lasts for 2 minutes (touch any key to stop the prompt tone) and it will stop automatically after 2 minutes.



Press  key, the draught fan runs less powerfully. Press it again and it stops. Press  key, the draught fan runs powerfully. Press it again and it stops.



Press  key enter the setting interface.  
 Press  to set 0 - 30 minutes of shutdown time delay by rolling up and down.  
 Press  to set the time and screensaver clock at the top of the interface by rolling up and down (if screensaver is set to be showed).  
 Press  to set your favorite screen backlight luminance.  
 Press  to set whether to show the clock screensaver clock interface or not.  
 Press  to return to the main interface.

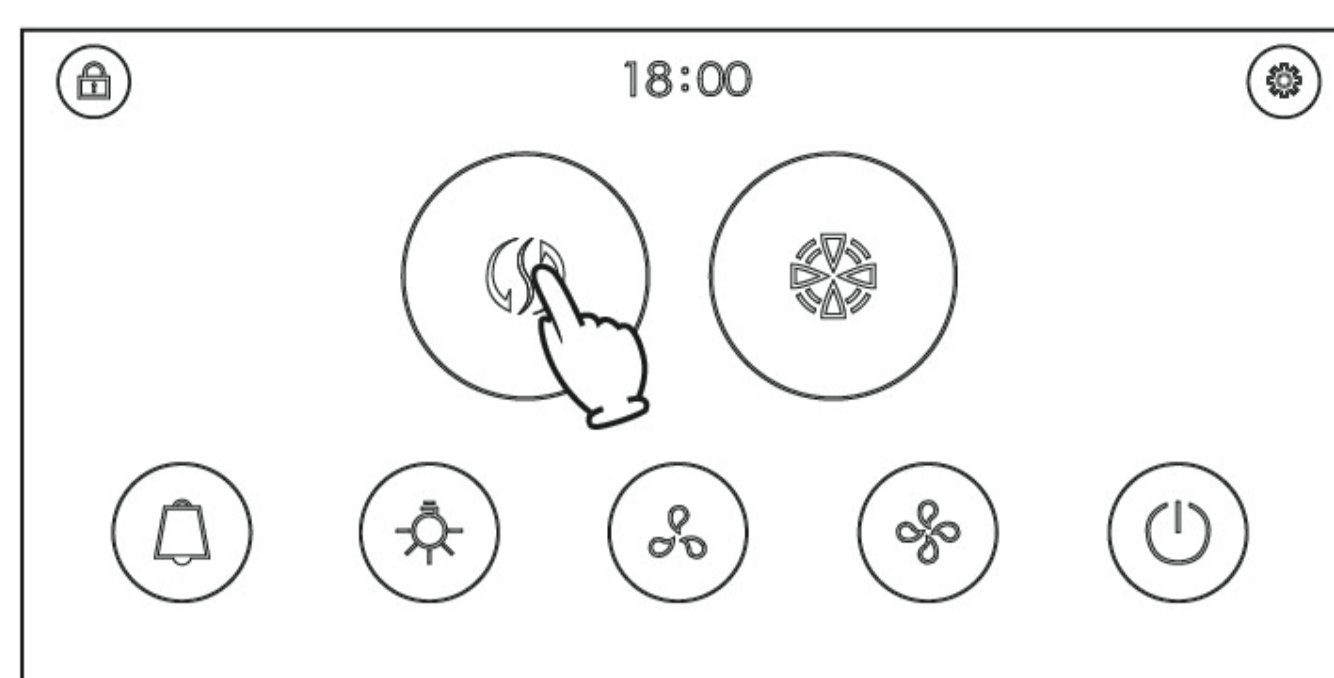

Press key to enter Kitchen Air Steward interface. The range hood can detect air quality automatically.

If air quality is good, the icon turns green and the motor does not run;

If air quality is slightly poor, the icon turns light red and hood works on weak mode;

If air quality is poor, the icon turns red and the hood works on strong mode.

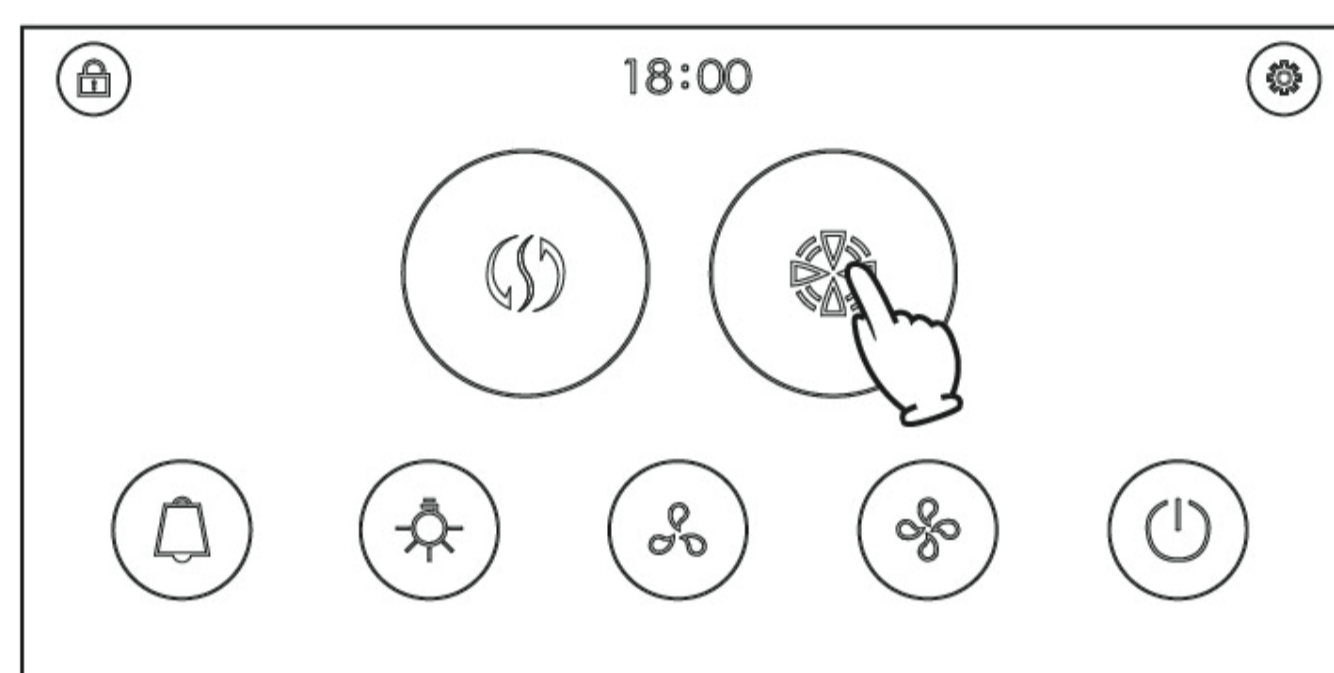

Press key and the range hood enters Auto turbo detection mode.

When high resistance is detected in the flue, the range hood directly runs the most powerfully. When low resistance is detected, the range hood runs powerfully again.

When we put food material into the pan, the blast cooking smoke will be the heaviest.

When sensing the sound at this moment, the hood range directly runs the most powerfully. When detecting no such sound in the pan, the hood range runs powerfully again.

■ **Illumination Function**

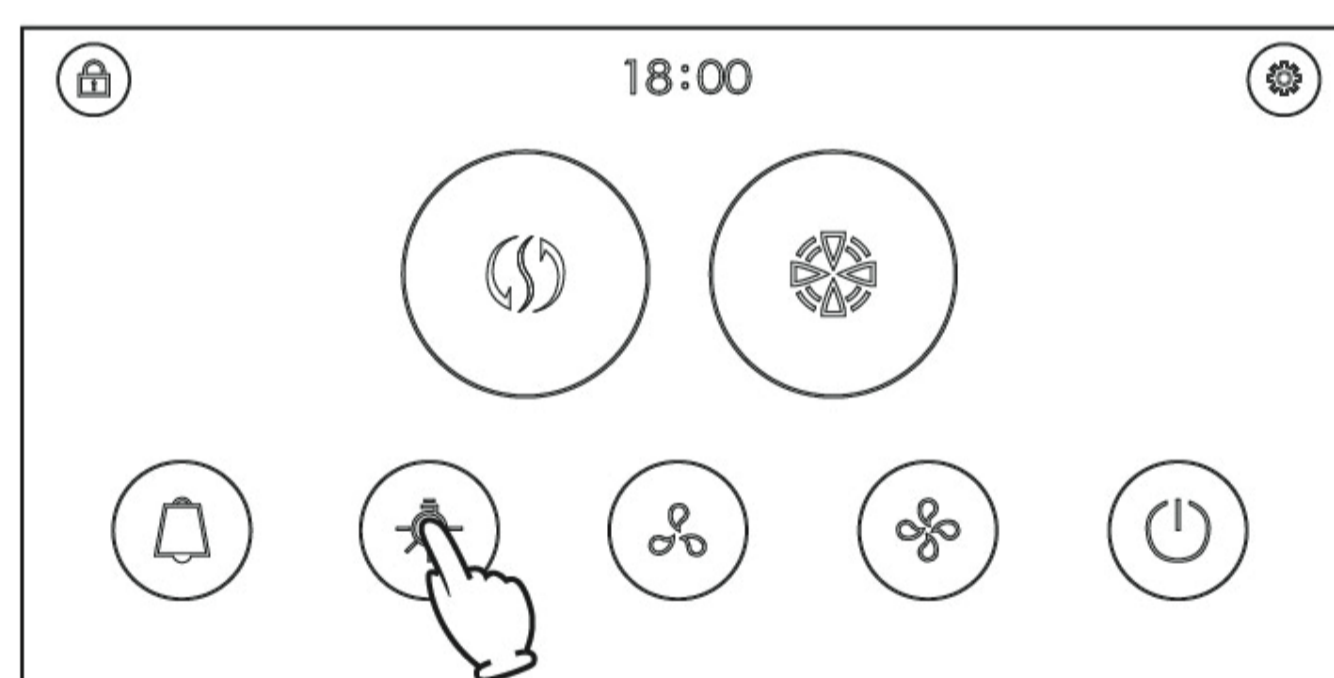

Press key and the lighting is on. Press it again and the lighting is off.

EMS9018

■ **Turn On/Off, Screenlock Function**

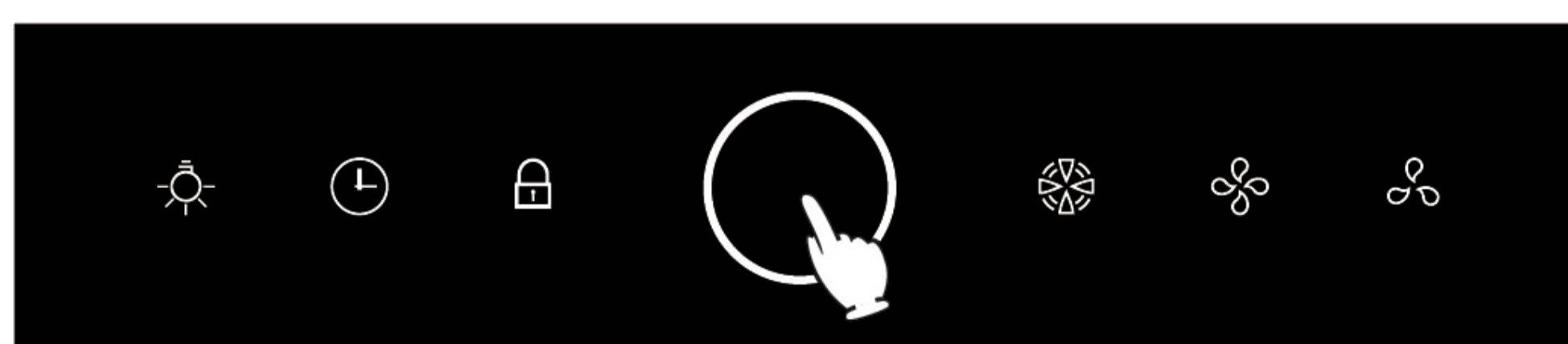

If you want to turn on the range hood, please press the key, the range hood is on standby, then you can press another key. If you don't have any operation on standby within 2 minutes, it will be turned off automatically.

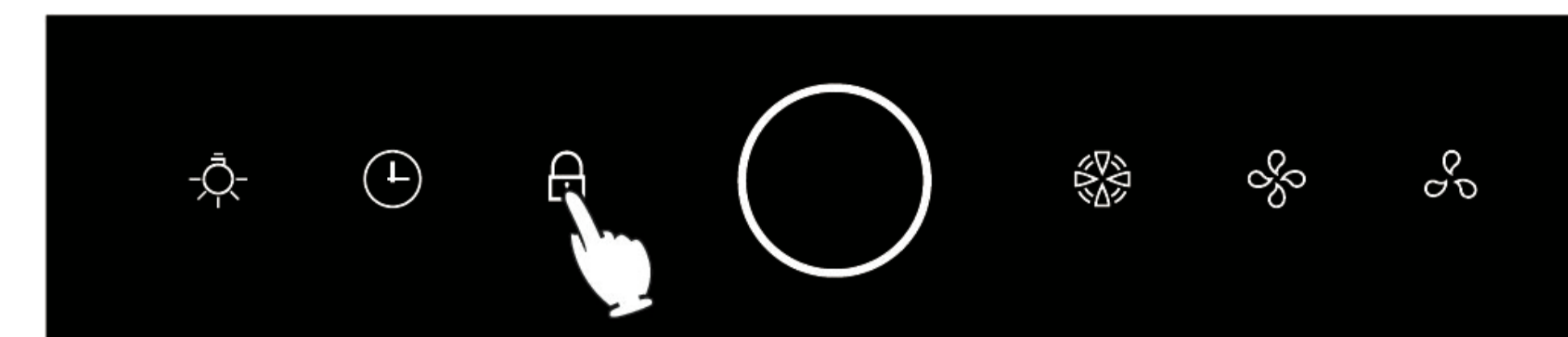

During working state or standby mode, Press the key at least with 3 seconds, the range hood beeps once, flashes on, all keys will be locked, and clicks invalid, the range hood will emit a beep; then press at least with 3 seconds, the screenlock function is canceled and resume.

■ **Time delay Function**

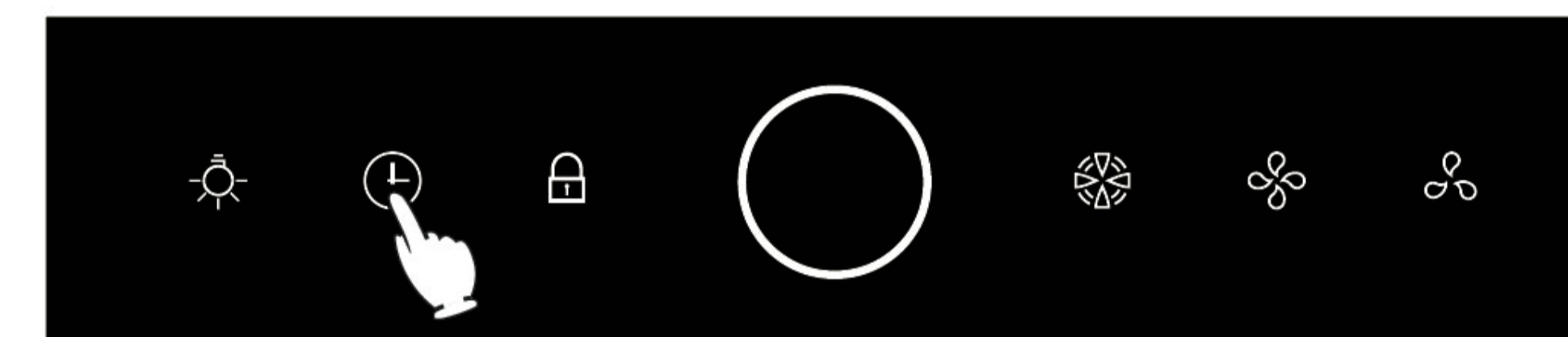

If you press when the range hood is working or on standby, it also will be turned off automatically after 2 minutes, if you need to cancel the delay, press any key.

■ **Suction Function**

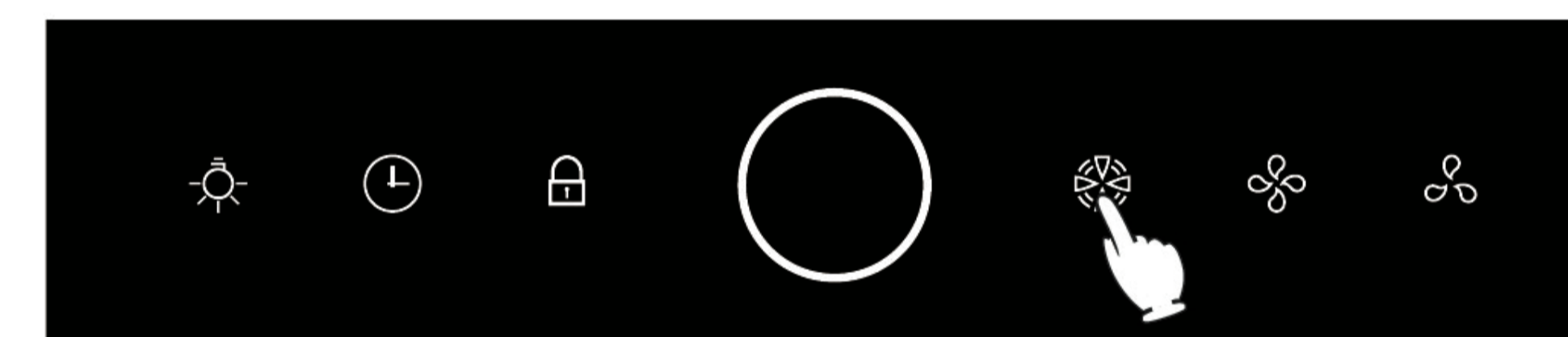

When is touched under the standby or operational mode, all indicator lighting are light; after the range hood maintaining for 5 seconds under the Auto turbo detection mode, and then returns to the normal mode and operate at the strong grade, the indicator lighting of button is semi-lighting, and the flue resistance shall be checked automatically, when the flue resistance is larger than the setting value, the motor turns to the Auto turbo detection mode to run automatically, at this time, the indicator lighting of button is fully-lighting; if the flue resistance restores to the normal condition, then after 30 seconds, it returns to the normal mode to run at the strong grade. If you want to turn off such function, press .

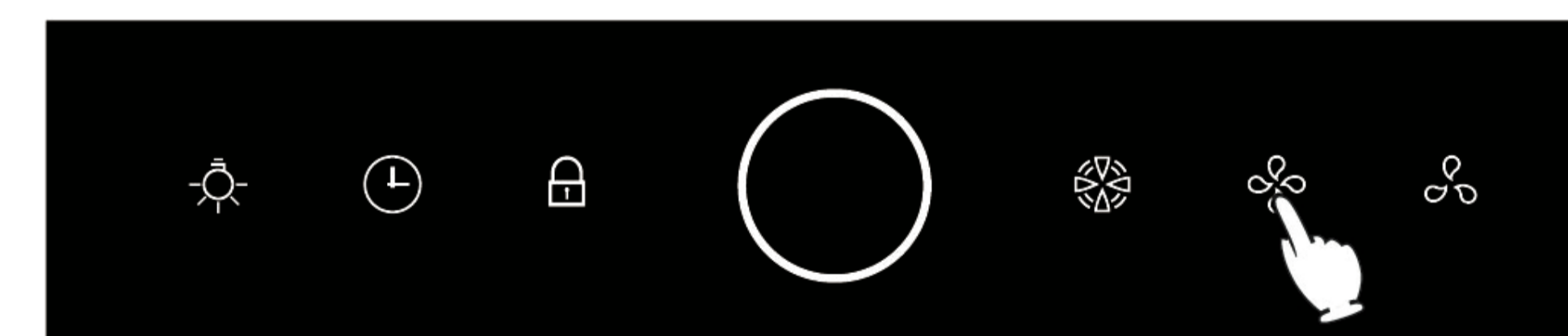

You press the key, the light indicator will show "on", the relevant working condition is "middle power". Press the key again, the light indicator will show "off", the relevant working condition is "off".

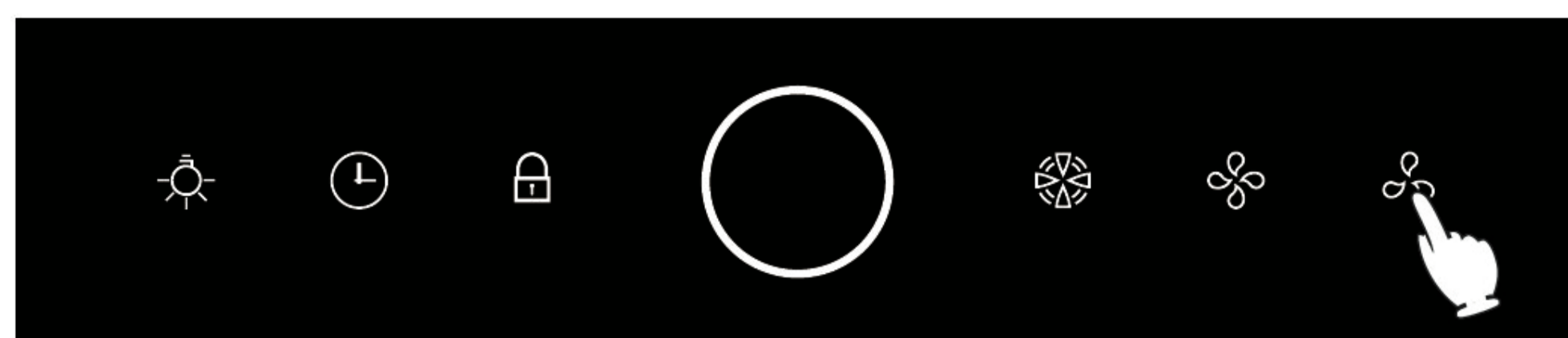

You press the key, the light indicator will show “on”, the relevant working condition is “weak power”. Press the key again, the light indicator will show “off”, the relevant working condition is “off”.

**■ Illumination Function**

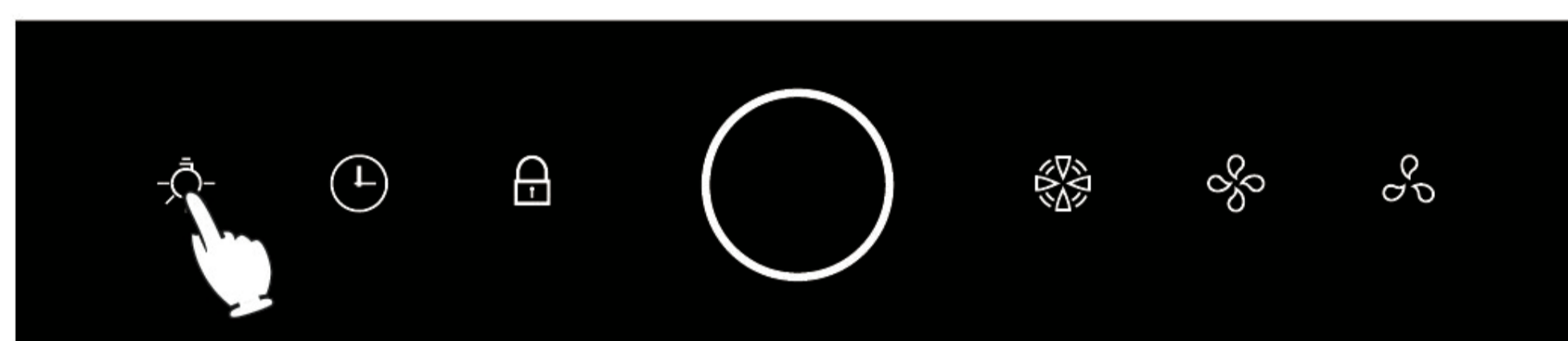

Press the key, the light is turned on, and press the key again, the light is off.

**Cleaning and Maintenance**

	<p>1. Cut off the power before cleaning.</p>		<p>2. All electric parts, include motor, switch, etc. should be away from water.</p>
	<p>3. Please don't clean the surface with rough material like steel wire ball, brush or coarse cloth, etc. It will greatly scratch the surface.</p>	<p>Neutral cleanser</p>	<p>4. Please don't clean with gasoline, acidic substance, benzene, solvent and other chemical agents. If you need to clean, please use neutral cleanser, and wipe dry the appliance surface by soft cloth after cleaning.</p>
<p>Wet cloth</p>	<p>5. If the stainless steel panel is stained with salty liquor, disinfectant, bleaching powder and other cleanser, please wipe it by wet cloth at once and dry it by dry cloth.</p>		<p>6. The two ends of the oil cup shall be held by both hands, maintain the horizontal level of the oil cup, and then move the oil cup towards the front side of the range hood, remove the oil cup and discharge the accumulated oil.</p>
			<p>7. Firstly, hold the front end of ring suction plate with both hands, turn downwards, so that the fastener of ring suction plate is out of place, meanwhile turn downwards for certain degree, remove the ring suction plate. And then hold the air input cover with left hand, and unscrew the 2 screws fixed on the air input cover with cross-screwdriver by right hand, then remove the air input cover.</p>

	<p>8. Remove the motor cover and decorative cover.</p>		<p>9. Unscrew the screws on the motor cover, and dismantle the motor cover.</p>
	<p>10. Unscrew the screws fixing on the air input ring, and remove the air input ring.</p>		<p>11. loosen the screw, take off the air inlet.</p>
	<p>12. Unscrew the locknut in clockwise direction, and remove the vane.</p>		<p>13. Screw off the locknut clockwise, Take out the impeller.</p>

- a. Pour out the gathering oil periodically according to the oil cup indication; please wipe the range hood surface once after every using the range hood; clean the air inlet outer cover and inner cover every three days; clean the impeller once every year (clean by professional people).
- b. Please frequently clean the range hood surface, rectification plate and oil cup.

**Normal Malfunction and Trouble Shooting**

Malfunctions	Possible reasons	How to check
Range hood can't work, light can't light on	Haven't connected with power supply	Check whether the plug is well inserted or not
		Check whether there is electricity or not in the plug
Motor can work, but light can't light on	LED light is damaged	Replace LED light (done by professional people)
There is machinery shaking noise	Screw is loosed	check whether the surface screws are tightened or not
Suction power is weak	Too long distance between range hood and stove	Lower the range hood installation height (done by professional people)
	Too much ventilation near the range hood leads to strong convection	Close some doors and windows
Noisy	Exhaust pipe surface is distorted	Reinstall exhaust pipe (done by professional people)

- 1. Change the LED light: please contact FOTILE after-sale service center.
- 2. If the range hood still can't work after getting rid of the above malfunctions, please contact FOTILE service center.





## Installation

### Packing List







	Complete Appliance	1		Wooden Screw 4.5x60	7
	Pothook	1		Oil Cup	1
	Decorative Cover	1		Safety Block	1
	Decorative Cover Pothook	1		Upper Seal Mat	1
	Cross Recess Head Self-tapping Screw ST 3.9x9.5	6		User Manual	1
	Expansion Pipe φ10X60	7		Exhaust Cover	1
	Cross recess pan head self-tapping locking screws M4 X 18	8		Ring suction plate assembly	1
	Collision Avoidance Elements	2			

### Installation Methods

#### ⚠️ Attention

 Attention	Suggest install the range hood after finishing the kitchen decoration.	 Forbidden	Make sure to keep the appliance horizontal.
 Strictly Execute	After finishing installation, make sure the range hood can normally work, please read carefully and keep well the user manual.	 Strictly Execute	Please abandon and recycle the old range hood which can't work any more, to protect the environment.

#### ⚠️ Attention

 Strictly Execute	If it is necessary to move the gas stove before installing the range hood, please close general gas valve before moving the gas stove.	 Strictly Execute	The range hood is heavy and the installation is complex, so the installation should be done by professional people according to the user manual.
 Strictly Execute	Please wear protective gloves to avoid your hands being hurt by rang hood sharp edge.	 Strictly Execute	Please use specialized power socket and it should be connected with reliable ground wire to ensure safety.
 Strictly Execute	Please do not damage the electric wire and other hidden equipment when drilling on wall. Power off the range hood when installing.	 Strictly Execute	The wall should be strong enough to support the range hood, otherwise the range hood may drop down and result in damage.
 Strictly Execute	Accessible parts may become hot when used with cooking appliances. The air must not be discharged into a flue that is used for exhausting fumes from appliances burning gas or other fuels Failure to install the screws or fixing device in accordance with these instructions may result in electrical hazards This appliance is not intended for using by persons (including children) with reduced physical, sensory or mental capabilities, or lack of experience and knowledge, unless they have been given supervision or instruction concerning use of the appliance by a person responsible for their safety. Children should be supervised to ensure that they do not play with the appliance.		
 Strictly Execute	Please use accessories provided by FOTILE company to ensure safe and well installation. Make sure the tightness between expansion pipe and wall hole, and please don't drill the hole too big, to avoid drop due to expansion pipe loosening.		
 Strictly Execute	Make sure the exhausting pipe can reach outdoors to avoid the fire and keep the fresh air in the room. Please don't make the waste gas stay indoor, loft, garage, etc. (This is only for ducted range hood)The waste air from the range hood couldn't share the same flue with other imflamble gas.		
 Strictly Execute	Package of new range hood:To keep a well environment, please deal with the plastic package by environmental way.Packing material is not toy, so please keep the plastic bags and box away from the infant to prevent such dangers as suffocation, etc.		

### Installation Suggestions

#### ■ Installation Position

The range hood is only for family use only; Please do not use the range hood under other conditions.

The range hood should be installed above the stove. Keep parallel between the blower outer cover bottom end and cabinet bottom end.

The temperature of the range hood should not be more than 104°F.

The wall should be none-flammable. Never install the range hood on the flammable wooden wall.



Range Hood and Wall Cupboard Standard Combination Size Installation Diagram

Unit: inch(mm)

EMS9016

Hole Size of Cabinet on Top Surface

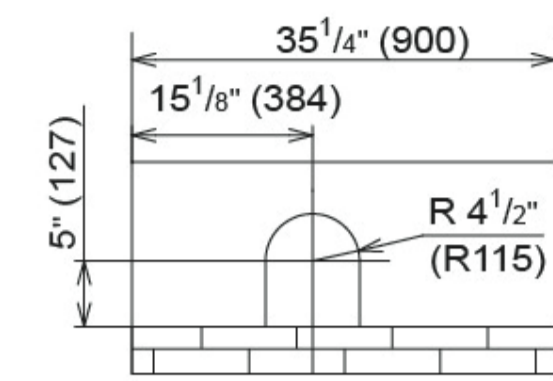

Exhaust pipe through cabinet

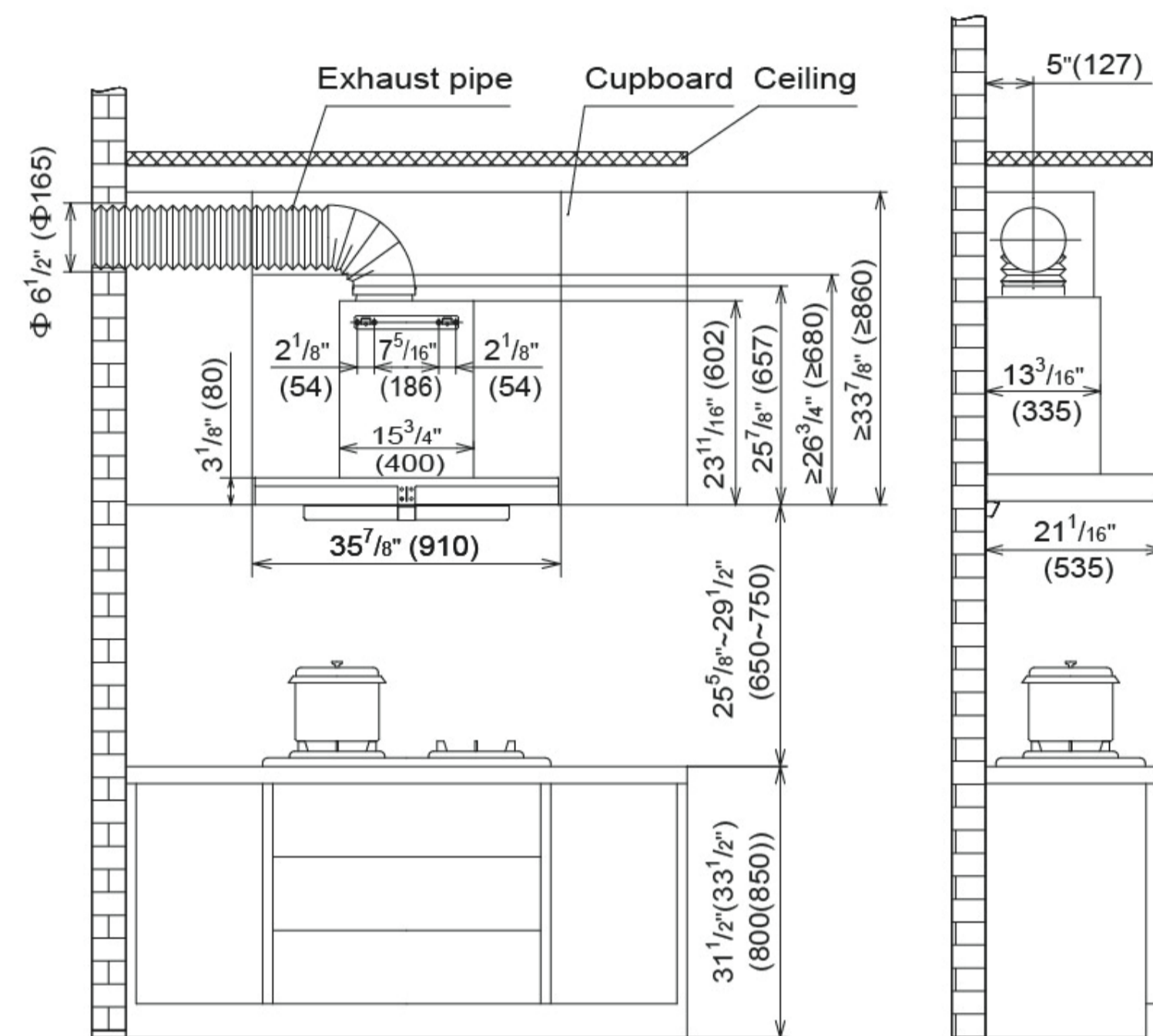

Installation diagram for the top decorative cover pothook.

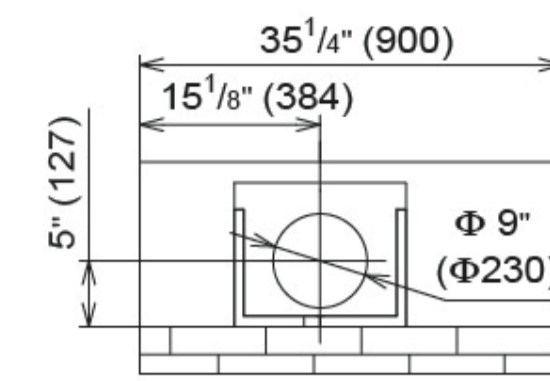

Exhaust pipe through ceiling

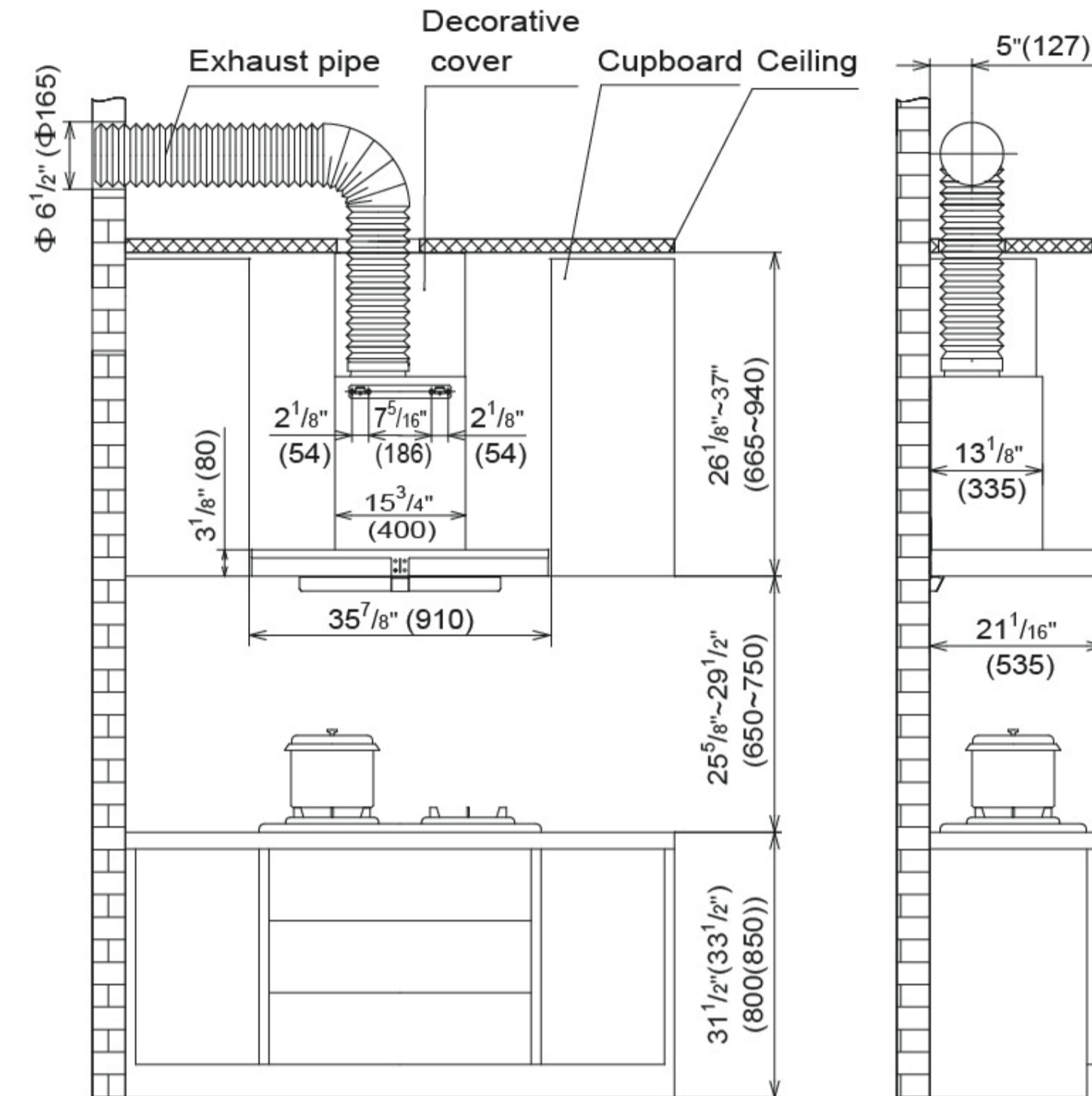

EMS9017

Hole Size of Cabinet on Top Surface

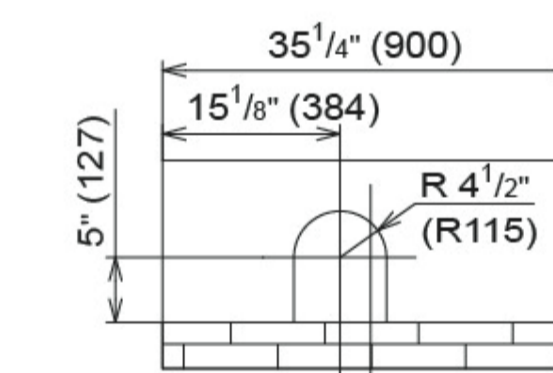

Exhaust pipe through cabinet

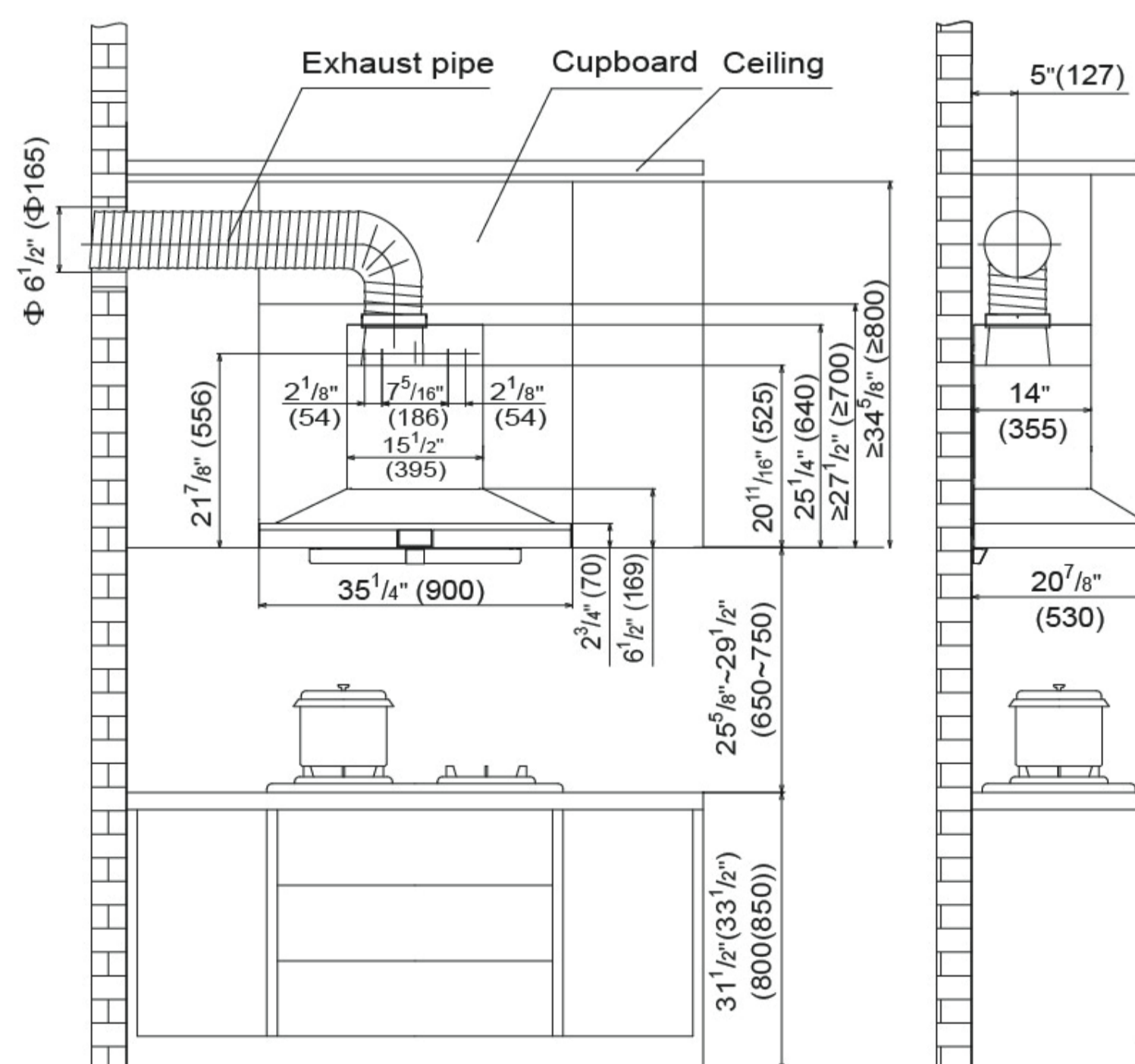

Installation diagram for the top decorative cover pothook.

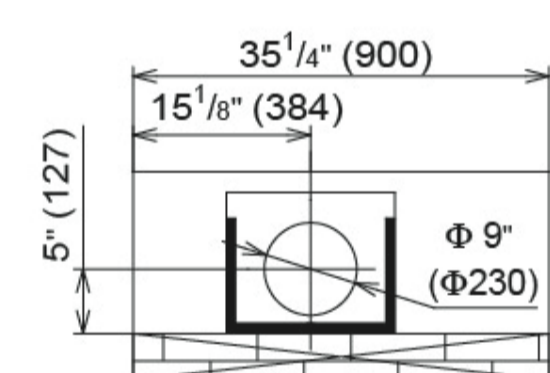

Exhaust pipe through ceiling

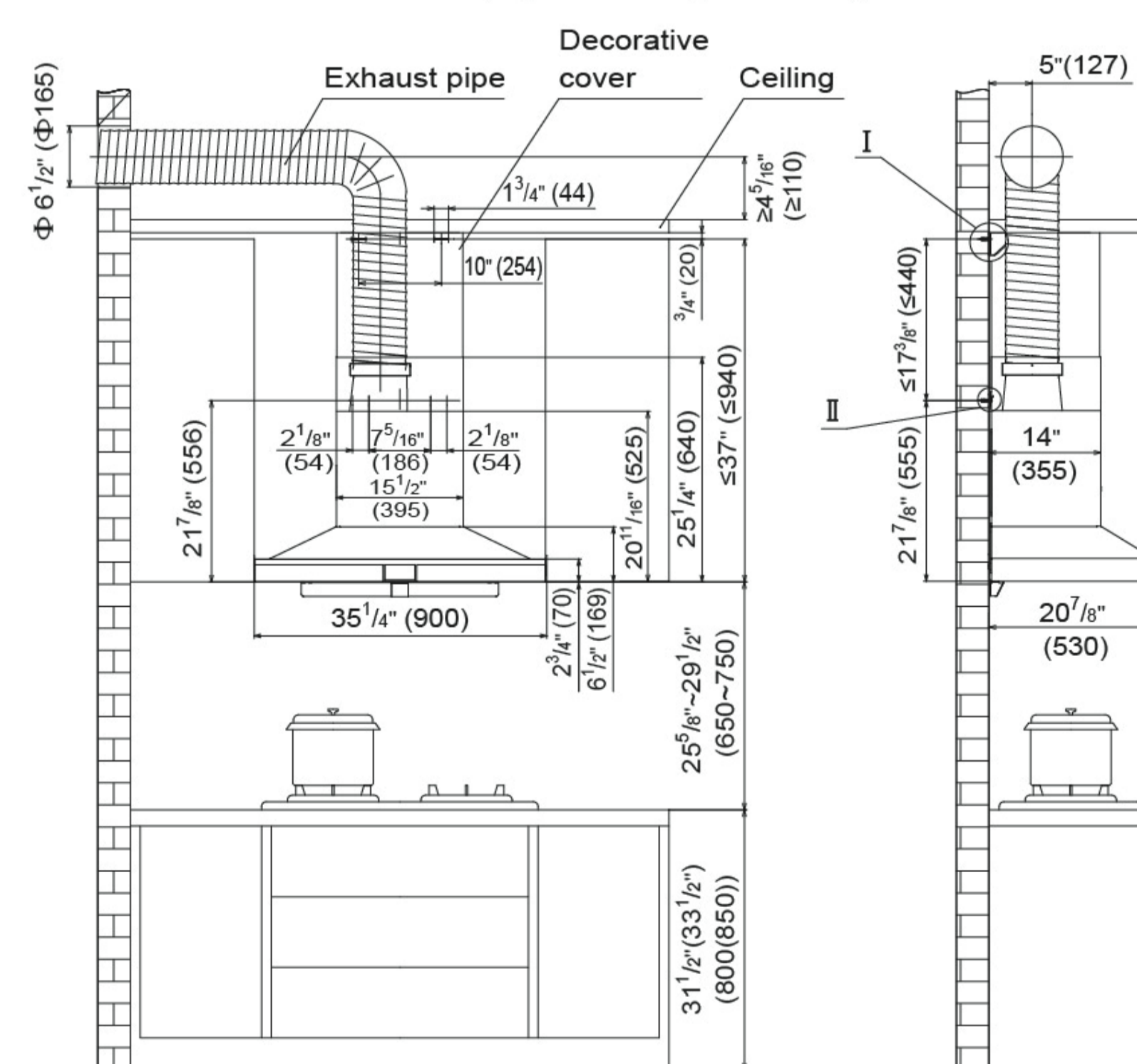

EMS9018

Hole Size of Cabinet on Top Surface

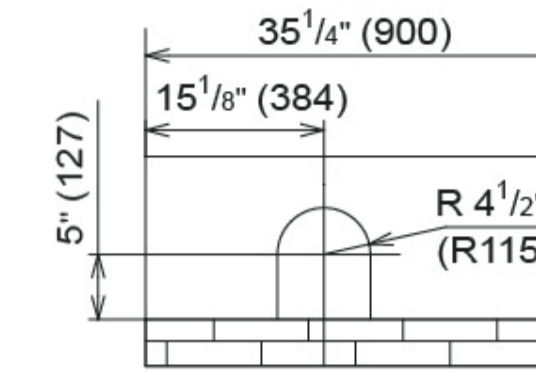

Exhaust pipe through cabinet

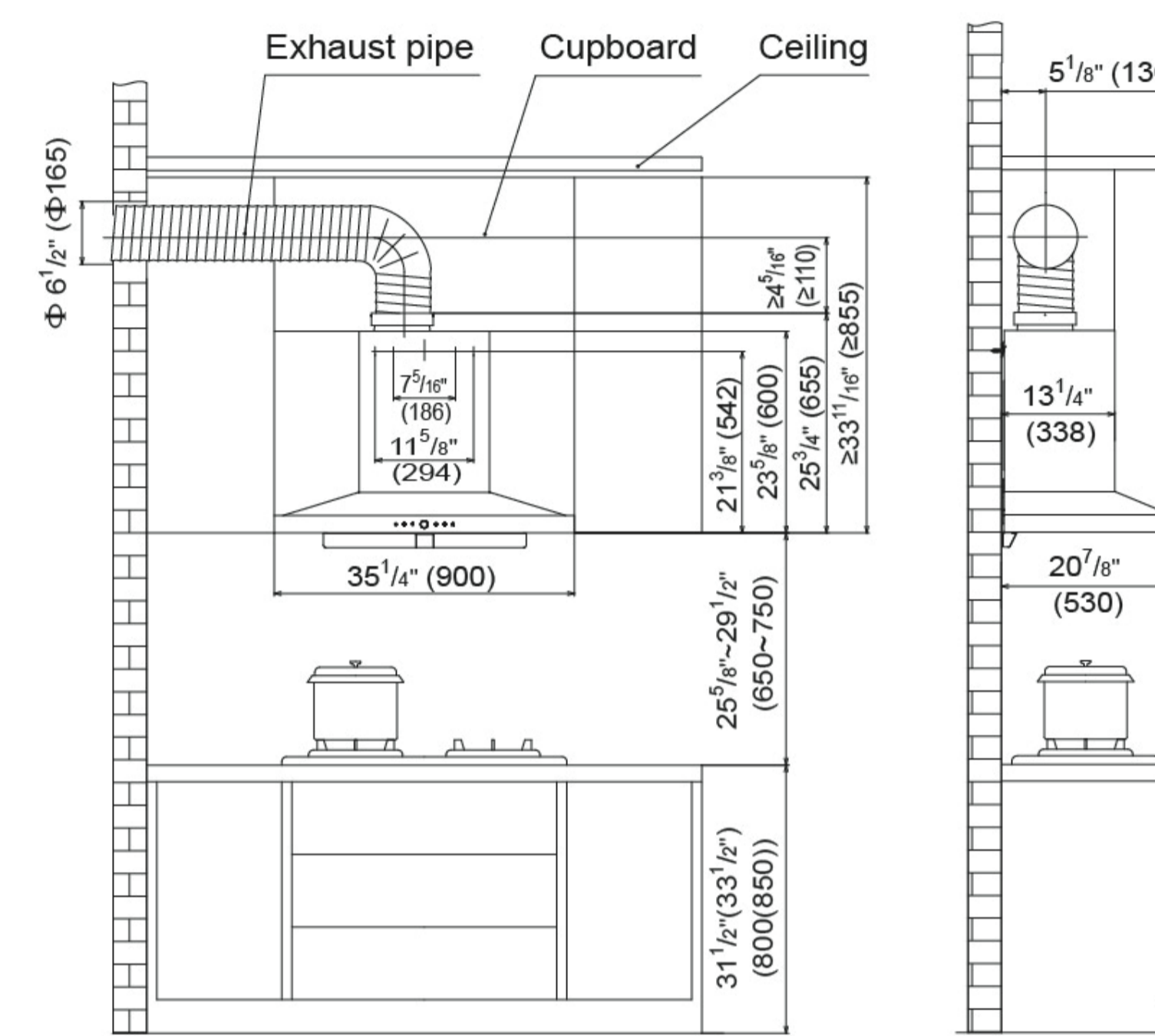

Installation diagram for the top decorative cover pothook.

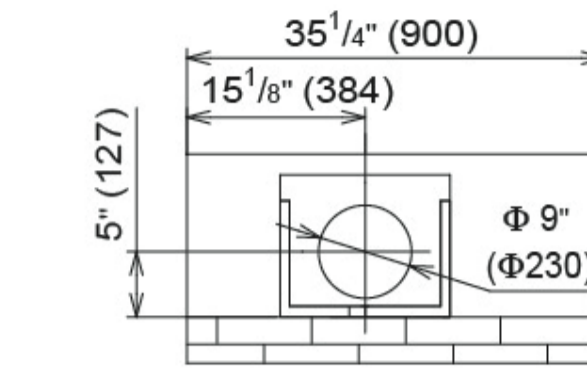

Exhaust pipe through ceiling

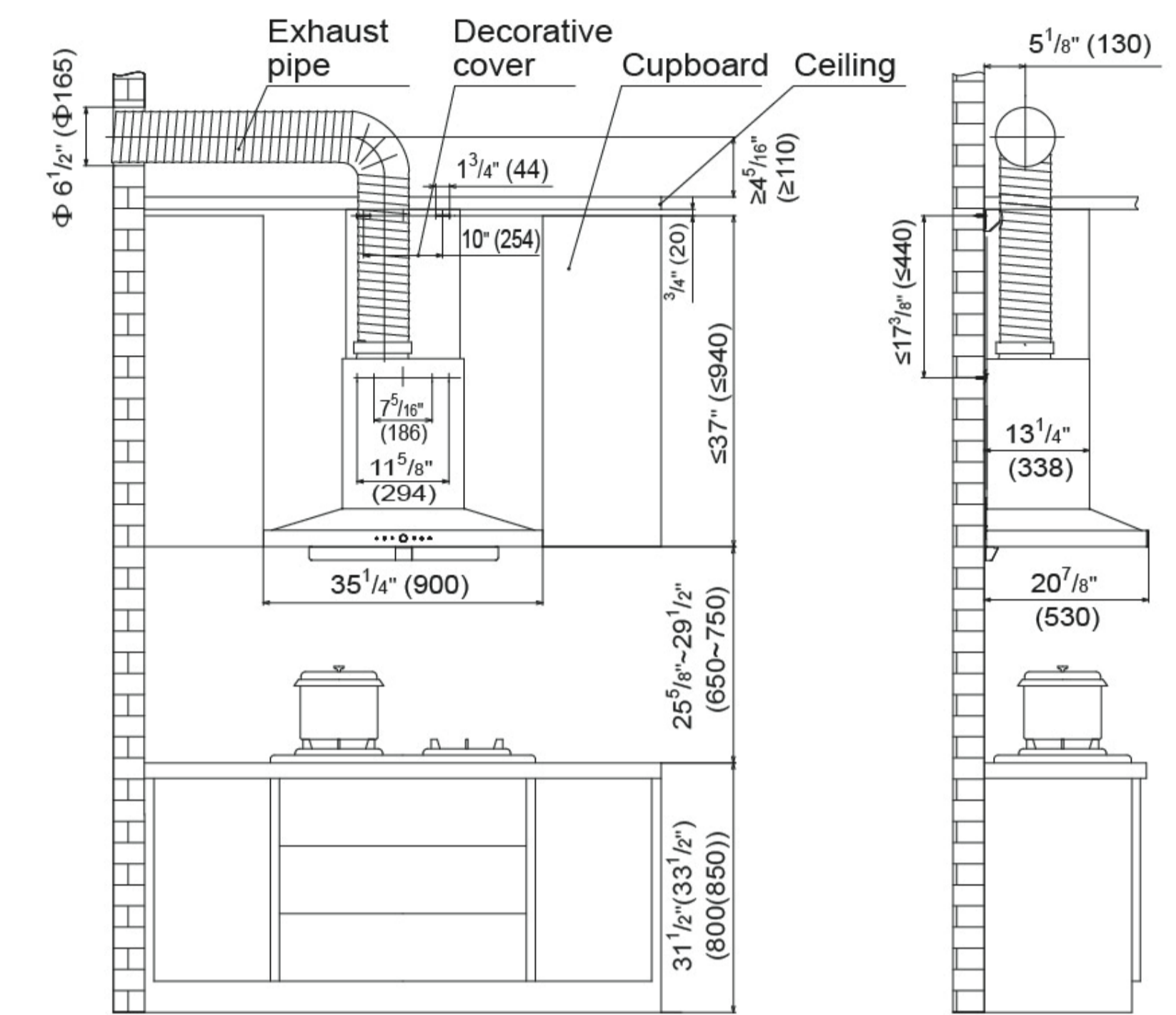

Blower outer cover bottom and cabinet bottom should be even.

Preparation before installation

- Warning, Please don't make sundries into exhaust pipe to avoid damaging the range hood. Estimate the exhaust pipe position. A straight and short exhaust pipe makes smoke extraction more smooth, please refer to installation diagram. The joint between exhaust pipe and wall hole should be sealed with tape, and ensure firm connection between exhaust pipe and exhaust cover. Too small wall hole will affect smoke extraction, therefore, please broaden the wall hole to fit exhaust pipe size under safety condition.
- Tool preparation  
Please prepare the following tools before range hood installation.
 

(1). Impact electric drill (with drillbit of $\Phi 3/8''$ )	(2). Cross screwdriver
(3). Internal hexagonal wrench (M6)	(4). Measuring taper
(5). Hammer	

**Installation Steps**

1. Demount the two screws which is for fixing the blower outer cover, take down the blower outer cover and decorative cover. Reserve  $\phi 3/8$ " drill bit for the impact electric drill.
2. Refer to Fig 1, set the right position on the wall to drill and then firmly imbed the expansion pipe. Insert wooden screws to tighten the fixed hook and decorative cover hook; you can also use two ST3.9X9.5 self-tapping screw to fix the decorative cover on the suspended ceiling.
3. Use eight M4×18 screws to fix the exhaust cover and sealing ring on the top of appliance.
4. Use ST3.9X9.5 self-tapping screws to fix the exhaust pipe on the exhaust cover.
5. Hang the hood firmly: face squarely- not slanting, side-looking-the hood will tightly stick the wall and a little lacune.
6. Install the exhaust pipe according to Fig 1: check the pipe shell is not bulging and not shriveled, curve freely. The exhaust pipe and wall should be tightly connected to prevent smoke back, the backflow barrier blade should be up and down smoothly.
7. Confirm the churn drilling hole position according to Fig 2, firmly imbed the expansion pipe, fix the safety block, and screw in the wooden screw to fix.
8. Blower outer cover and decorative cover installation
  - (1) Put the decorative cover inside of the blower outer cover.
  - (2) Take up the blower outer cover and decorative cover meantime; inject the decorative cover into its pothook, then push the decorative cover and blower outer cover along the pothook assembly to the end.
  - (3) After pushing the decorative cover and blower outer cover to the end, the blower outer cover will slip down slowly, and inject the blower outer cover buckle to the blower rack, then insert the blower outer cover to the gap which is between top panel and blower rack.

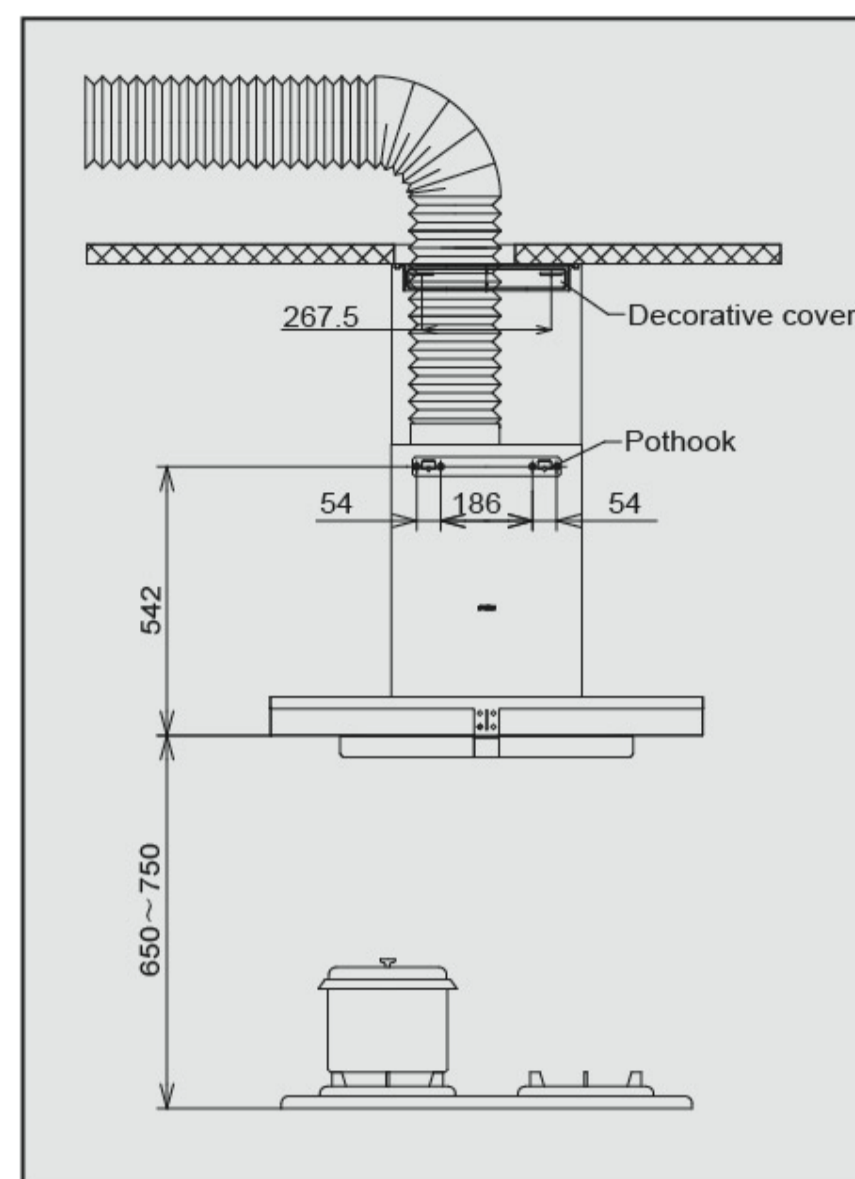

Fig.1

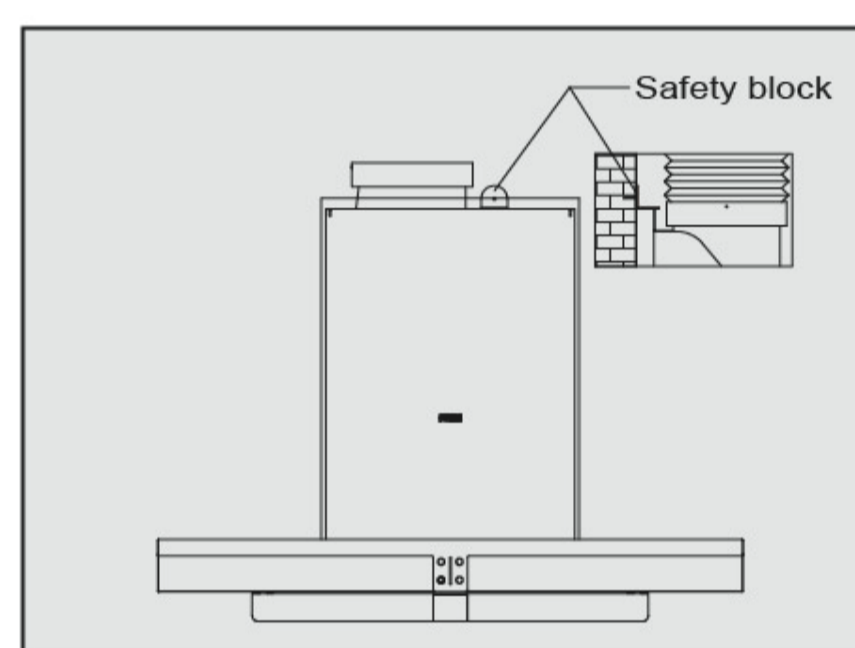

Fig.2

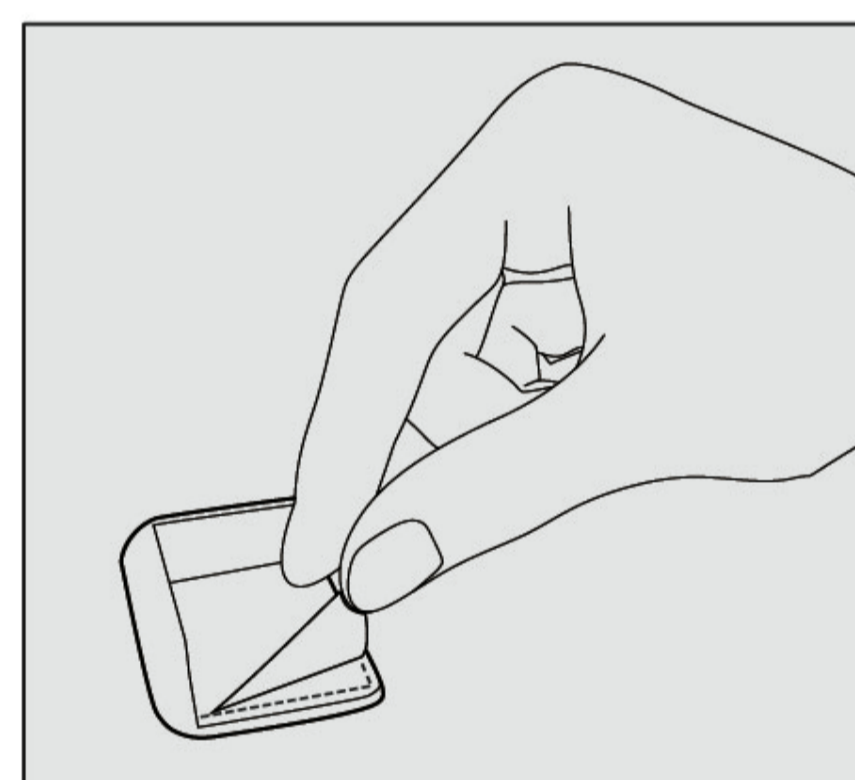

Fig.3



- a. Please take down the blower outer cover before installation.
- b. If you install the range hood matching with cabinet, then exchange Step (4) and Step (5).
- c. Please select right drill bit according to the drilling place specific situation.

9. Installation of ring suction plate

- (1) Hold the front side of the ring suction plate firmly with both hands, and place the left and right pothooks on the rear side of ring suction plate into the left and right hook racks of the smoke collecting hood;
  - (2) Prop the ring suction plate with both hands, make it spiral upward, push in while the ring suction plate spirals, finally make the touch claw on the ring suction plate insert into the touch button on the smoke collection hood;
10. Install anti-collision accessories, firstly remove the double faced adhesive tape (see Figure 3), then stick the anti-collision accessories to the corner of the smoke exhaust (see Figure 4);
  11. Install the oil cup assemblies(see Figure 5);
  12. Insert the host power plug into the power outlet.

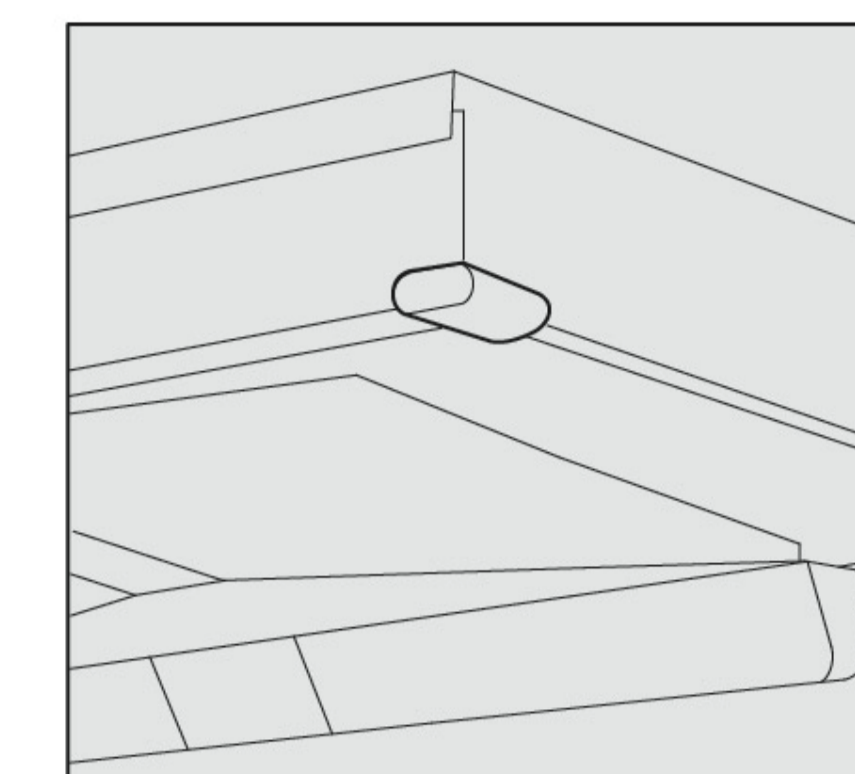

Fig.4

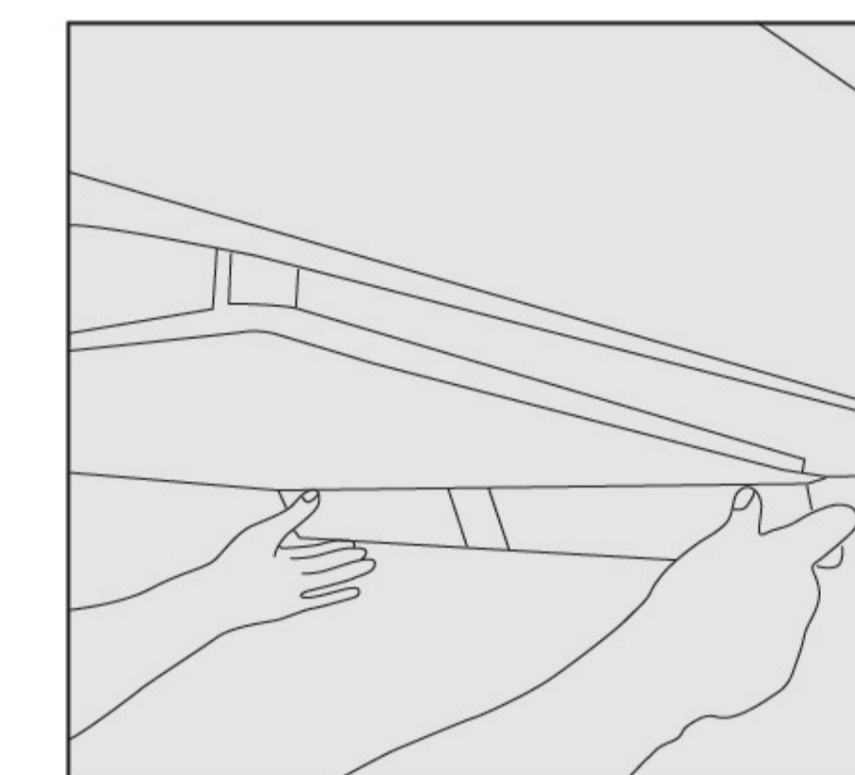

Fig.5

**Debugging**

1. Connect the power plug.
2. Press the "☀" button, check the light
3. Press the "⚙" button, to check if the motor is at normal operation. If there is abnormality, Please turn off the power immediately, and check if it is the problem of installation. (Please contact with FOTILE distributor or service center.)
  - (1) The body of hood shakes heavily.
  - (2) The expansion pipe is loose.
  - (3) The impeller doesn't work.
  - (4) Big noise from the impeller running.
  - (5) Abnormal noise from motor.
4. press the Power key, the turbine and the light are off.

Main Technical Specifications

Model		EMS9016/EMS9017/EMS9018
Voltage/Frequency		120V/60Hz
Rated power input of the range hood		310W (light power included 2W)
Noise	Auto Turbo System setting	71dB(A)
	high setting	64dB(A)
	low setting	58dB(A)
Max static pressure		501Pa

Caution:

- The dB(A) noise in the above table is tested in accordance with IEC60704 standard, which indicates the sound power level. Pressure level, to answer for : Auto Turbo System setting 57 dB、high setting 50 dB、low setting 44 dB.
- Such parameters as noise may have a deviation of less than 5%.

Component Name Diagram

EMS9016

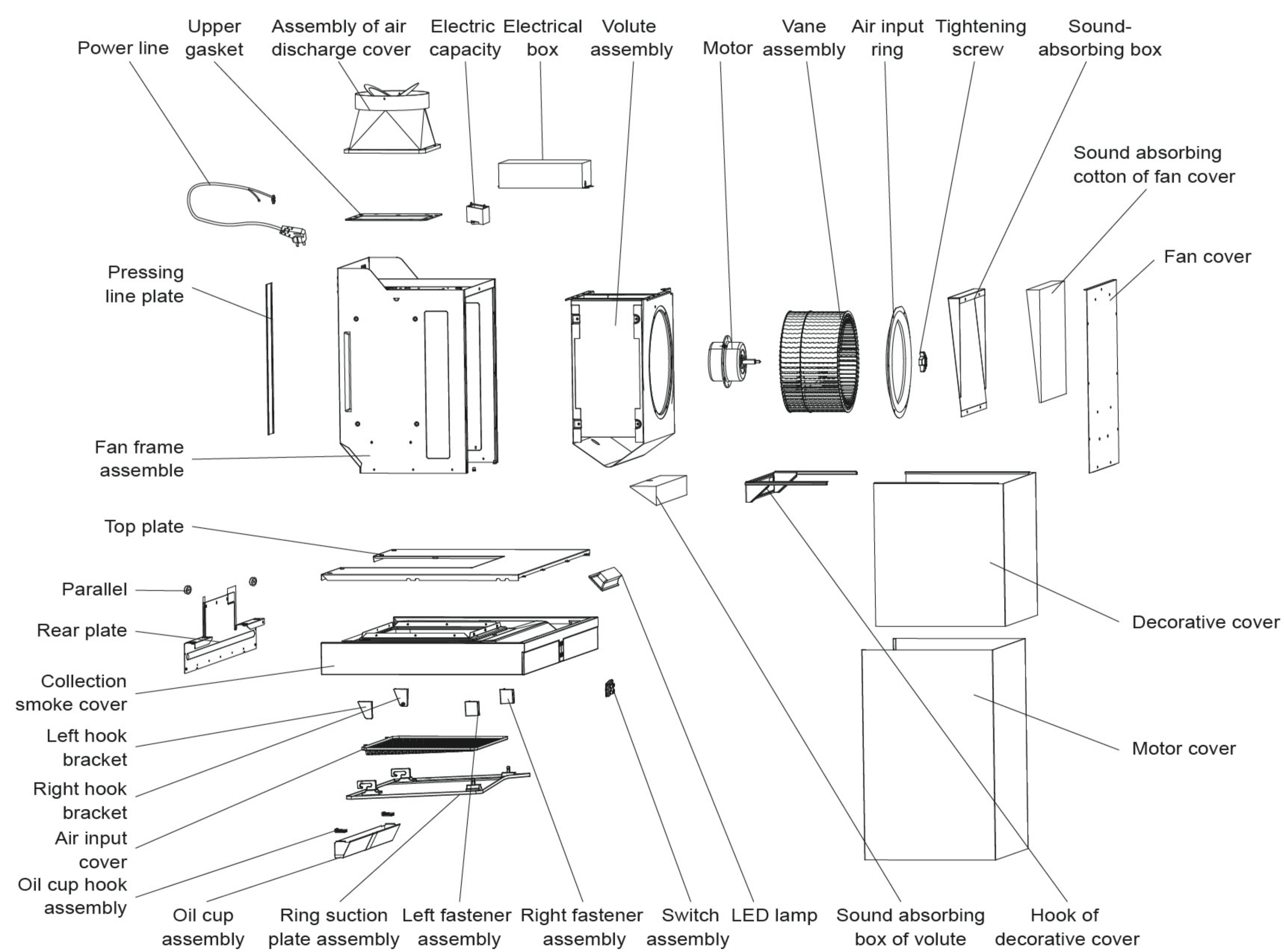

EMS9017

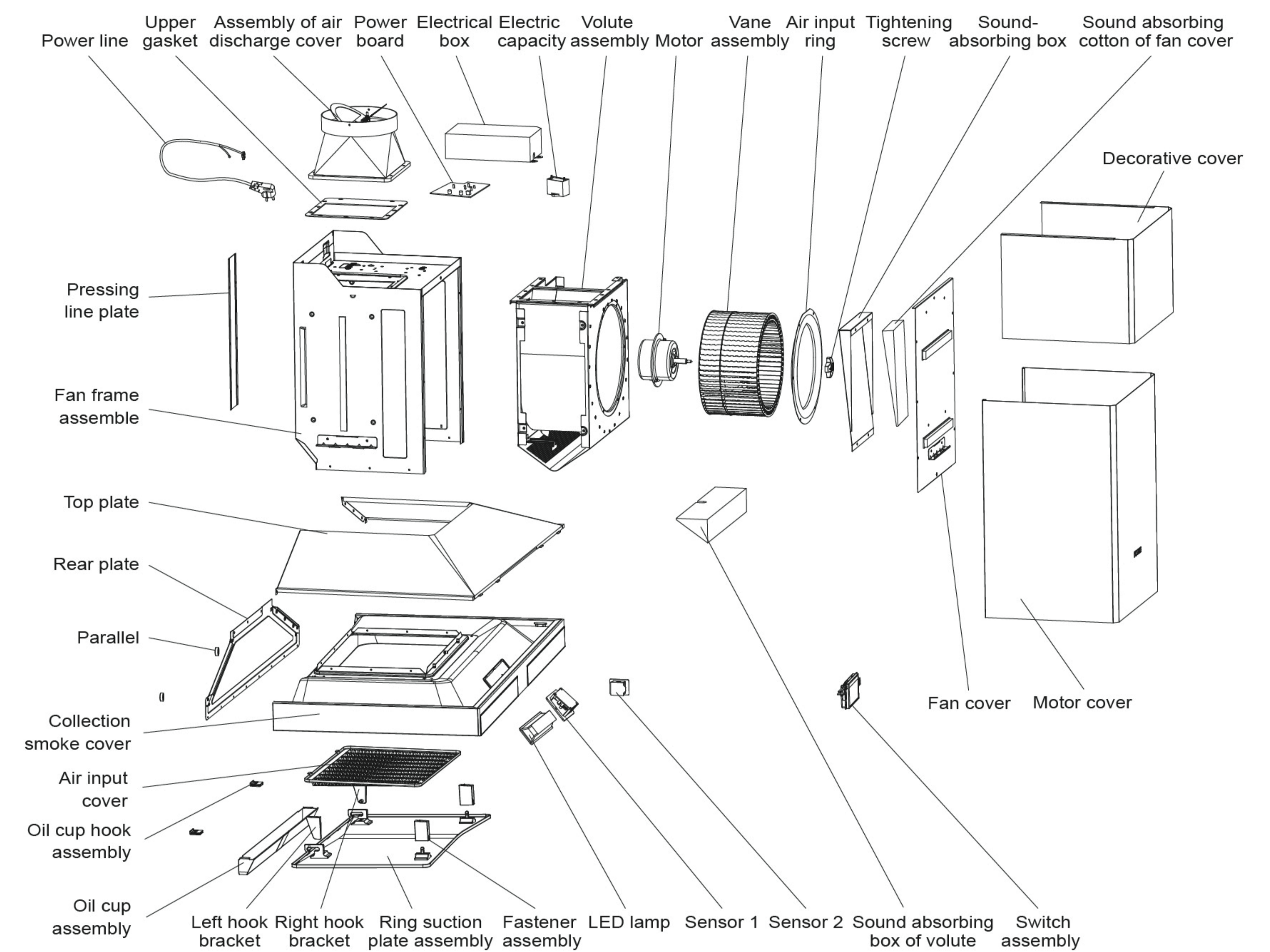

EMS9018

