

# Use & Care MANUAL



## **6 SERIES** Built-in Electric Single and Double Wall Ovens

*MVSOE630 / CMVSOE630  
MVDOE630 / CMVDOE630*

# Congratulations

Your purchase of this product attests to the importance you place upon the quality and performance of the major appliances you use. With minimal care, as outlined in this guide, this product is designed to provide you with years of dependable service. Please take the few minutes necessary to learn the proper and efficient use and care of this quality product.

Some of the key features of this appliance include:

- A broad range of baking and broiling modes—up to 11 cooking modes in all—to make even your most challenging baking projects a success.
- A two-speed convection fan that allows you to cook foods more thoroughly and evenly—even when baking large quantities.
- Four convection modes offering greater air circulation to shorten cooking times and cook foods more evenly.
- Dual broiling elements producing intense radiant heat for faster broiling and a larger coverage area.
- Three broiling modes including a new low-broil mode for delicate broiling and top-browning.
- A meat probe offers perfect baking/roasting of meats.
- A halogen lighting system to provide more light with less glare.
- A concealed bake element for easier cleaning.
- Six adjustable rack positions with the largest usable baking space available in this class.

Your complete satisfaction is our ultimate goal. If you have any questions or comments about this product, please our Consumer Support Center at 1-888-845-4641.

We appreciate your choosing a Viking Range product and hope that you will again select our products for your other major appliance needs. For more information about the complete and growing selection of our products, visit us online at [vikingrange.com](http://vikingrange.com)

# Table of Contents

Warnings & Safety	4
Oven Features	8
Digital Display	9
Clocks and Timers	9
Using the Oven	12
Preheat	12
Bake	12
Convection Bake	13
Convection Roast	16
Meat Probe	18
Broil	19
Cleaning and Maintenance	21
Self-Clean	22
Replacing Oven Lights	23
Service Information	24
Warranty	26

# Warnings & Safety

Warning and Important Safety Instructions appearing in this manual are not meant to cover all possible conditions and situations that may occur. Common sense, caution, and care must be exercised when installing, maintaining, or operating the appliance. ALWAYS contact the manufacturer about problems or conditions you do not understand.

## Recognize Safety Symbols, Words, Labels

<b>⚠ DANGER</b>
Hazards or unsafe practices which <b>WILL</b> result in severe personal injury or death
<b>⚠ WARNING</b>
Hazards or unsafe practices which <b>COULD</b> result in death or severe personal injury
<b>⚠ CAUTION</b>
Hazards or unsafe practices which <b>COULD</b> result in minor personal injury. All safety messages will identify the hazard, tell you how to reduce the chance of injury, and tell you what can happen if the instructions are not followed.

**Read and follow all instructions** before using this appliance to prevent the potential risk of fire, electric shock, personal injury or damage to the appliance as a result of improper usage of the appliance. Use appliance only for its intended purpose as described in this manual.

**To ensure proper and safe operation:** Appliance must be properly installed and grounded by a qualified technician. **DO NOT** attempt to adjust, repair, service, or replace any part of your appliance unless it is specifically recommended in this manual. All other servicing should be referred to a qualified servicer.

**KEEP THESE INSTRUCTIONS FOR FUTURE REFERENCE.**

<b>⚠ WARNING</b>
 To avoid risk of property damage, personal injury or death; follow information in this manual exactly to prevent a fire or explosion. <b>DO NOT</b> store or use gasoline or other flammable vapors and liquids in the vicinity of this or any appliance.

<b>⚠ WARNING</b>
To reduce the risk of fire, electric shock, or injury to persons, installation work and electrical wiring must be done by qualified people in accordance with all applicable codes and standards, including fire-rated conditions.

<b>⚠ WARNING</b>
<b>NEVER</b> use this appliance as a space heater to heat or warm the room. Doing so may result in carbon monoxide poisoning and overheating of the drawer.

<b>⚠ WARNING</b>
<b>NEVER</b> cover any slots, holes or passages in the drawer or cover an entire rack with materials such as aluminum foil. Doing so blocks air flow through the oven and may cause carbon monoxide poisoning. Aluminum foil linings may also trap heat, causing a fire hazard.

<b>⚠ CAUTION</b>
<b>DO NOT</b> store items of interest to children over the unit. Children climbing to reach items could be seriously injured.

# Warnings & Safety

## ⚠ WARNING

**DO NOT** use commercial oven cleaners inside the oven. Use of these cleaners can produce hazardous fumes or can damage the porcelain finishes.

## ⚠ WARNING

To prevent possible damage to cabinets and cabinet finishes, use only materials and finishes that will not discolor or delaminate and will withstand temperatures up to 194°F (90°C). Heat and moisture resistant adhesive must be used if the product is to be installed in laminated cabinetry. Check with your builder or cabinet supplier to make sure that the materials meet these requirements.

## ⚠ CAUTION

This appliance is not to be used by persons (including children) with reduced physical, sensory or mental capabilities, or lack of experience and knowledge, unless they have been given supervision or instruction concerning the use of the appliance by a person responsible for their safety. Children should be supervised to ensure that they do not play with the appliance.

## ⚠ WARNING



**BURN OR ELECTRICAL SHOCK HAZARD**  
Make sure all controls are OFF and drawer is COOL before cleaning. Failure to do so can result in burns or electrical shock.

## ⚠ WARNING



**ELECTRICAL SHOCK HAZARD**  
Disconnect the electric power at the main fuse or circuit breaker before replacing bulb.

## ⚠ NOTICE

Avoid any damage to oven vents. The vents need to be unobstructed and open to provide proper airflow for optimal oven performance.

## ⚠ WARNING

**DO NOT** cook on the oven bottom. This could result in damage to your appliance. Always use oven racks when cooking in the oven.

## ⚠ WARNING

This appliance features a self-cleaning cycle. During this cycle, the oven reaches elevated temperatures in order to burn off soil and deposits. A powder ash residue is left in the bottom of the oven after completion of the self-clean cycle. **Note: DO NOT** use commercial oven cleaners inside the oven. Use of these cleaners can produce hazardous fumes or can damage the porcelain finishes. **DO NOT** line the oven with aluminum foil or other materials. These items can melt or burn during a self-clean cycle, causing permanent damage to the oven.

## ⚠ WARNING

### BURN HAZARD



When self-cleaning, surfaces may get hotter than usual. Therefore, children should be kept away.

## ⚠ WARNING



**DO NOT** touch the exterior portions of the oven after self-cleaning cycle has begun, since some parts become extremely hot to the touch!

During the first few times the self-cleaning feature is used, there may be some odor and smoking from the "curing" of the binder in the high-density insulation used in the oven. When the insulation is thoroughly cured, this odor will disappear. During subsequent self-cleaning cycles, you may sense an odor characteristic of high temperatures.

KEEP THE KITCHEN WELL-VENTED DURING THE SELF-CLEAN CYCLE.

## ⚠ CAUTION

### BURN HAZARD



The oven door, especially the glass, can get hot. Danger of burning: **DO NOT** touch the glass!

## ⚠ WARNING

### ELECTRICAL SHOCK HAZARD



**DO NOT** touch a hot oven light bulb with a damp cloth as the bulb could break. Should the bulb break, disconnect power to the appliance before removing bulb to avoid electrical shock

# Warnings & Safety

## **⚠ WARNING**

To avoid sickness and food waste when using automatic time baking:

- **DO NOT** use foods that will spoil while waiting for cooking to start, such as dishes with milk or eggs, cream soups, custards, fish, pork, poultry, or foods with stuffing.
- Any food that has to wait for cooking to start should be very cold or frozen before it is placed in the oven.
- **DO NOT** use foods containing baking powder or yeast with automatic time baking. They will not rise properly.
- **DO NOT** allow food to remain in the oven for more than 2 hours after the end of the cooking cycle.
- To avoid sickness and food waste, **DO NOT** allow defrosted food to remain in the oven for more than 2 hours.

## **⚠ NOTICE**

The cooling fan should be operating when the unit is in operation. If you notice the cooling fan is not operating or you observe unusual or excessive noise coming from the cooling fan, contact a Viking Range Authorized Service Center before continuing operation. Failure to do so can result in damage to the oven or surrounding cabinets.

### **To Prevent Fire or Smoke Damage**

- Be sure all packing materials are removed from the appliance before operating it.
- Keep area around appliance clear and free from combustible materials, gasoline, and other flammable vapors and materials.
- Many aerosol-type spray cans are **EXPLOSIVE** when exposed to heat and may be highly flammable. Avoid their use or storage near an appliance.
- Many plastics are vulnerable to heat. Keep plastics away from parts of the appliance that may become warm or hot.
- Combustible items (paper, plastic, etc.) may ignite and metallic items may become hot and cause burns. **DO NOT** leave oven unsupervised when drying herbs, breads, mushrooms, etc., as this may create a fire hazard.

### **In Case of Fire**

- Turn off appliance to avoid spreading the flame.
- Smother fire or flame by closing the oven door.
- **DO NOT** use water on grease fires. Use baking soda, a dry chemical or foam-type extinguisher to smother fire or flame.

### **Child Safety**

- **NEVER** leave children alone or unsupervised near the appliance when it is in use or is still hot.
- **DO NOT** store items of interest to children over the unit. Children climbing to reach items could be seriously injured.
- Children must be taught that the appliance and utensils in it can be hot. Let hot utensils cool in a safe place, out of reach of small children. Children should be taught that an appliance is not a toy. Children should not be allowed to play with controls or other parts of the appliance.

### **Cooking Safety**

- Use dry, sturdy pot-holders. Damp pot-holders may cause burns from steam. Dishtowels or other substitutes should **NEVER** be used as potholders because they can get caught on appliance parts.
- Loose-fitting or hanging garments should never be worn while using the appliance. **DO NOT** drape towels or materials on oven door handles. These items could ignite and cause burns.
- **ALWAYS** place oven racks in the desired positions while oven is cool. Slide oven rack out to add or remove food, using dry, sturdy pot-holders. **ALWAYS** avoid reaching into the oven to add or remove food. If a rack must be moved while hot, use a dry pot-holder.
- **ALWAYS** turn the oven off at the end of cooking.
- **DO NOT** heat unopened food containers; buildup of pressure may cause the container to explode and result in injury.
- Use care when opening the oven door. Let hot air or steam escape before moving or replacing food.
- **NEVER** use aluminum foil to cover oven racks or oven bottom. This could result in risk of electric shock, fire, or damage to the appliance. Use foil only as directed in this guide.
- **DO NOT** cook on the oven bottom. This could result in damage to your appliance. Always use oven racks when cooking in the oven.
- **PREPARED FOOD WARNING:** Follow food manufacturer's instructions. If a plastic frozen food container and/or its cover distorts, warps, or is otherwise damaged during cooking, immediately discard the food and its container. The food could be contaminated.

# Warnings & Safety

## Heating Elements

- NEVER touch oven heating elements, areas near elements, or interior surfaces of oven.
- Heating elements may be hot even though dark in color. Areas near elements and interior surfaces of an oven may become hot enough to cause burns.
- During and after use, DO NOT touch or let clothing or other flammable materials contact heating elements, areas near elements, or interior surfaces of oven until they have had sufficient time to cool.

## Self-Clean Oven

- Clean only parts listed in this guide. DO NOT clean door gasket. The door gasket is essential for a good seal. Care should be taken not to rub, damage, or move the gasket. DO NOT use oven cleaners of any kind in or around any part of the self-clean oven.
- Before self-cleaning the oven, remove broiler pan, oven racks and other utensils and wipe up excessive spill-overs to prevent excessive smoke, flare-ups or flaming.
- This oven features a cooling fan which operates automatically during a clean cycle. If the fan does not turn on, the unit will not operate. The user should contact Service for repair.

## Important Safety Notice and Warning

The California Safe Drinking Water and Toxic Enforcement Act of 1986 (Proposition 65) requires the Governor of California to publish a list of substances known to the State of California to cause cancer or reproductive harm, and requires businesses to warn customers of potential exposures to such substances. Users of this appliance are hereby warned that when the oven is engaged in the self-clean cycle, there may be some low-level exposure to some of the listed substances, including carbon monoxide. Exposure to these substances can be minimized by properly venting the oven to the outdoors by opening the windows and/or door in the room where the appliance is located during the self-clean cycle.

## Important notice regarding pet birds:

NEVER keep pet birds in the kitchen or in rooms where the fumes from the kitchen could reach. Birds have a very sensitive respiratory system. Fumes released during an oven self-cleaning cycle may be harmful or fatal to birds. Fumes released due to overheated cooking oil, fat, margarine and overheated non-stick cookware may be equally harmful.

## About Your Appliance

- For proper oven performance and operation, DO NOT block or obstruct the any vents above or below the doors.
- Avoid touching oven vent area while oven is on and for several minutes after oven is turned off. When the oven is in use, the vent and surrounding area become hot enough to cause burns. After oven is turned off, DO NOT touch the oven vent or surrounding areas until they have had sufficient time to cool.
- Other potentially hot surfaces include oven vent, surfaces near the vent opening, oven door, areas around the oven door, and oven window.
- The misuse of oven doors (e.g. stepping, sitting, or leaning on them) can result in potential hazards and/or injuries.

## Before Using the Oven

**Important! Before first use, wipe interior with soapy water and dry thoroughly.**

# Oven Features

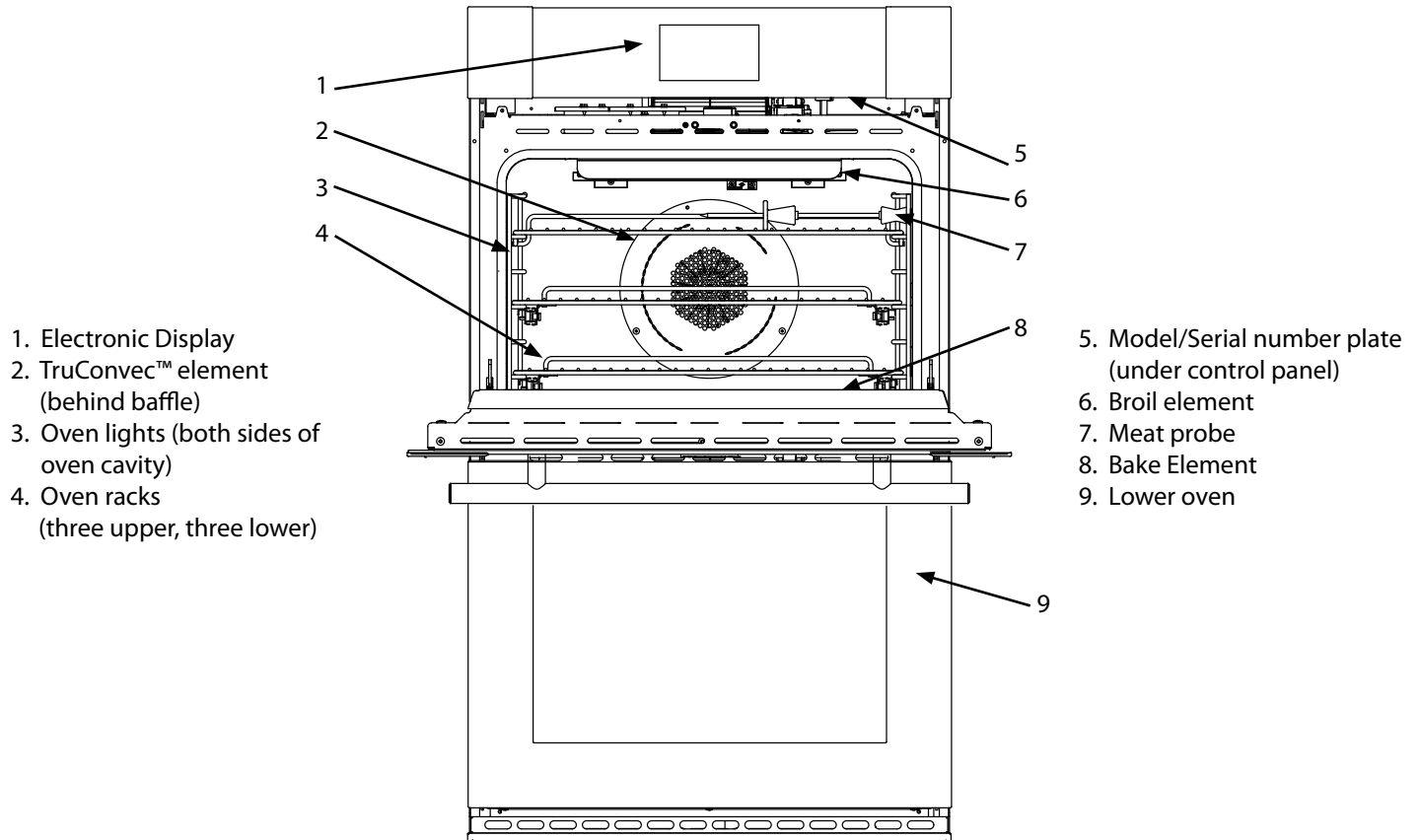

## Oven Functions and Settings

Both ovens feature nine cook modes:

- Bake
- Convection Bake
- TruConv
- Conv Roast
- Broil - Hi, Med, LO
- Conv Broil
- Self-Clean

Both ovens have two top heating elements, a fan and heating element in the back of the cook cavity, and a bottom heating element. Unlike most traditional ovens, the bottom heating element is concealed beneath the cook cavity. This feature allows for a bigger cook cavity, easier cleaning, and more uniform heating.



# Digital Display

When unit is first plugged up, display will show time.

This is considered the sleeping mode. To activate, tap display. and the cooking functions will appear

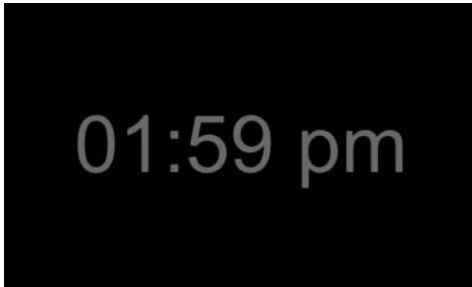

## Clock and Timers

### Setting the Clock and Personal Preferences on the Utilities Screen

You can access the Utilities screen from any screen. Tap the three dots above the time to access the menu.

For access to the utilities, including the clock, tap the three dots above the clock time at the top of the screen. The tab will pull up, showing three sections, Timer, Utility, and Advance.

Use the utilities to set the clock or alter personal preferences such as the display and the sounds.



### Setting the Clock

1. At the Utilities screen, tap clock.
2. Choose between 12 HR/24HR, AM/PM, Visible/Hidden by pressing desired button above the keypad.
3. Enter desired time using keypad. Once correct time is displayed, press enter.
4. Exit Utility functions by pressing the three dots at the top of the screen above the time.



### Adjusting Personal Preferences

From the Utilities screen you can also adjust such features as the touch screen brightness (select Display) and the volume and notification settings (select Sound).

For Display: tap Display. Press "-" or "+" to lighten or darken the screen. 1 if for the least and 7 is for the most brightness.



For Sound: tap Sound. Press "-" or "+" to increase or decrease the beeper volume. 1 is for the lowest and 3 is the highest volume. 0 turns the volume off.



# Digital Display

## Setting the Timer

1. Tap the three dots above the time to access the menu.
2. Select the Timer tab.
3. Enter the desired time for the timer and press start. The timer will begin to count downward. Oven will beep when time has expired.
4. After timer has started, you can either pause the timer or cancel. Press pause. To resume, press start. To cancel, press stop.



To access the cooking functions:

1. Tap the screen
2. Scroll down to desired function
3. Once the cooking function is selected, the temp and cook time will appear. Default temperatures will display - Bake 350°, Conv Bake - 350°, TruConv - 325°, Conv Roast - 325°, Conv Broil - 550°, Broil HI - 550°, Broil Med - 425°, Broil Lo 325°
4. To change the default temp, tap the temp. Keypad will appear. Press clr, enter new temp. Press enter. To enter time, tap time. Using keypad, enter desired time, press enter.



5. Oven will begin to preheat.

# Digital Display

## Showroom Mode

1. Tap the three dots above the time to access the menu.
2. Select the Utility tab.
3. Select Showroom Mode.
4. Click either the on or off mode depending on function desired. When unit is in showroom mode, only the lights and display will work.



## Autostart

1. Tap the three dots above the time to access the menu.
2. Select the Utility tab.
3. Select Autostart
4. Set cooking options
  - Cooking mode
  - Start time - AM or PM
  - Cooking time - **NOTE:** when setting cooking time, add 30 minutes to allow for oven to preheat.
  - Temp.



5. Once all of the cooking preferences are set, press OFF/ON to show ON.



# Using the Oven

## Preheat / No Preheat

### Preheat - Used in all Baking modes except Convection Bake

For best results, it is extremely important that you preheat your oven to the desired cooking temperature before placing food items in the oven to begin cooking. In many cooking modes, partial power from the broiler is used to bring the oven to the preheat temperature. Therefore, placing food items in the oven during preheat mode is not recommended. The Viking Rapid Ready™ Preheat System is engineered so that the oven is brought to the desired set temperature in a manner which will provide the optimum cooking environment based on the selected cooking mode in the shortest possible time.

For instance, the preheat mode for TruConvec™ is designed to be brought up to the set point temperature in a different manner than the preheat mode for BAKE. This is because TRUCONVEC is designed for multi-rack baking. So it is extremely critical that all rack positions have reached the desired cooking temperature. As a result, it is normal for oven to take slightly longer for the oven to preheat to 350°F (180°C) in TRUCONVEC mode when compared to the amount of time it takes to preheat to 350°F (180°C) in BAKE mode.

Also, preheat time can vary based on some external factors such as room temperature and power supply. A significantly colder room temperature or a power supply less than 240 VAC can lengthen the time it takes for the oven to reach the desired set temperature.

### No Preheat Option - Convection Bake Mode only

- Turn oven to Convection Bake and select the desired temperature (lower temperature by 25 degrees for convection setting).
- Place the food item/dish in the oven on the middle oven rack (single rack baking only).
- Check food occasionally to monitor the cooking process. Most of the time, the food will cook for the same amount of time and sometimes slightly faster than usual.

## Rack Positions

Each oven is equipped with three heavy-duty racks, including two TruGlide™ racks. With the TruGlide™ racks, the bottom section remains in the oven and the top section smoothly glides outward when pulled. This reduces the chances of spills from items that contain a lot of juice or liquid. This rack can be used in any of the six rack positions.

All ovens have five rack positions. Position 5 is the farthest from the oven bottom. Position 1 is the closest to the oven bottom. The racks can be easily removed and arranged at various levels. For best results with conventional baking, do not use more than one rack at a time. It is also recommended, when using two racks, to bake with the racks in positions 2 and 4 or positions 3 and 5.

1. Arrange the oven racks in the desired positions BEFORE heating the oven. If cooking on two racks at the same time, use rack positions 2 and 4 or positions 3 and 5.
2. Turn the Oven Function selector to desired function. Cooking starts immediately and stops when the Oven Function selector is turned to "OFF".
3. Set the Temperature Control to the desired temperature.
4. Place the food in the oven after the oven indicator light goes out.

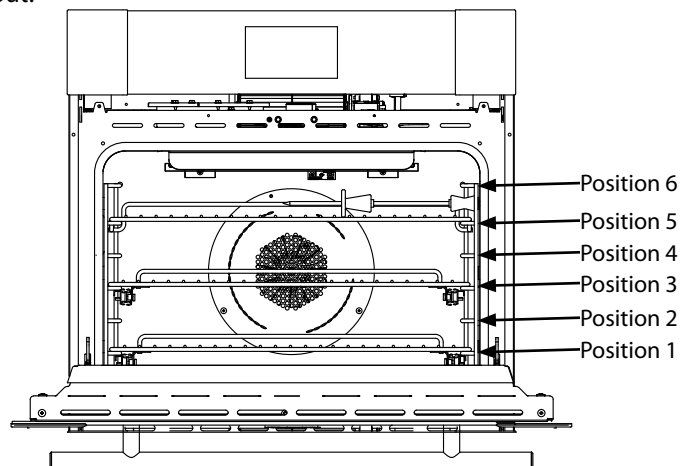

# Using the Oven

## Bake

Traditionally, baking is to cook with dry heat. Hot air from the top and bottom of the oven envelops the food in a radiant dry heat, which combines with a little moisture from the food to become a circulating vapor in the oven.

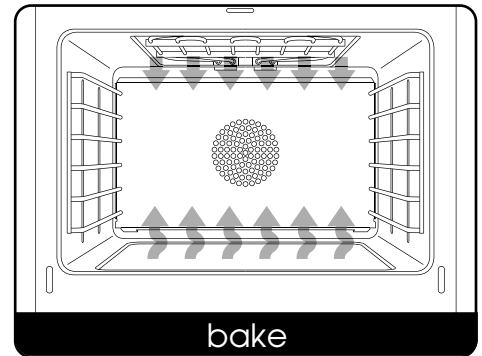

## Convection Bake

Convection Bake uses the same heating elements as Bake, with the addition of a convection fan and heater in the back of the cook cavity. This fan and heater help heat and circulate the air evenly throughout the chamber to produce superior browning and crisping.

Any food cooked in the Bake mode can also be prepared using Convection Bake and vice versa. In general, items cooked in Convection Bake will cook about 33% faster than when cooked in Bake. The temperature should be reduced by 25° F.

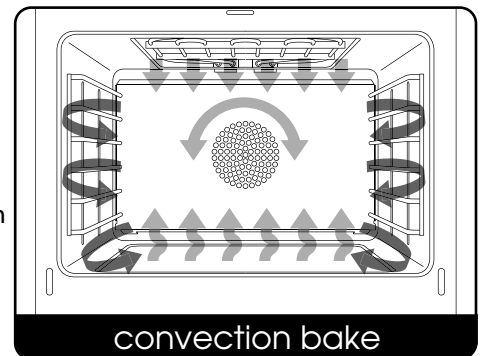

## TruConv (TruConvec™)

The rear element only operates at full power. There is no direct heat from the bottom or top elements. The motorized fan in the rear of the oven circulates air in the oven cavity for even heating. Use this setting for foods that require gentle cooking such as pastries, souffles, yeast breads, quick breads and cakes. Breads, cookies, and other baked goods come out evenly textured with golden crusts. No special bakeware is required. Use this function for single-rack baking, multiple-rack baking, roasting, and preparation of complete meals. This setting is also recommended when baking large quantities of baked goods at one time.

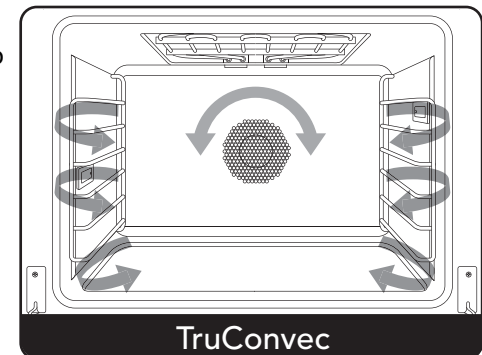

# Using the Oven

## Bake and Convection Bake Cooking Tips

Because of variations in food density, surface texture and consistency, some foods may be prepared more successfully using the conventional bake setting. For this reason, conventional baking is recommended when preparing baked goods such as custard. The user may find other foods that are also prepared more consistently in conventional bake. This is perfectly normal. Convection cooking is a cooking technique which utilizes fan forced air to circulate heat throughout the entire oven creating the optimum cooking environment. Cooking with convection is intended when performing multi-rack baking and for baking heavier foods. Below are tips which will allow you to get the best results out of your oven when cooking with convection.

- As a general rule, to convert conventional recipes to convection recipes, reduce the temperature by 25°F (-3.9°C) and the cooking time by approximately 10 to 15%.
- Cooking times for standard baking and convection baking will be the same. However, if using convection to cook a single item or smaller load, then it is possible to have 10-15% reduction in cooking time. (Remember convection cooking is designed for multi-rack baking or cooking large loads.)
- If cooking items which require longer than 45 minutes, then it is possible to see a 10-15% reduction in cooking time. This is especially true for large items cooked in the convection roast function.
- A major benefit of convection cooking is the ability to prepare foods in quantity. The uniform air circulation makes this possible. Foods that can be prepared on two of three racks at the same time include: pizza, cakes, cookies, biscuits, muffins, rolls, and frozen convenience foods.
- For three-rack baking, use any combination of rack positions 2, 3, 4, and 5. For two-rack baking, use rack positions 2 and 4 or positions 3 and 5. Remember that the racks are numbered from bottom to top. See "Oven Features" section.
- Items cooked in a convection function can be easily over-baked. This being the case, it is usually a good idea to pull items out of the oven just before they seem to be done. Items will continue to cook right after they are set out of the oven.
- Some recipes, especially those that are homemade, may require adjustment and testing when converting from standard to convection modes. If unsure how to convert a recipe, begin by preparing the recipe in conventional bake. After achieving acceptable results, follow the convection guidelines listed for the similar food type. If the food is not prepared to your satisfaction during this first convection trial, adjust only one recipe variable at a time (cooking time, rack position, or temperature) and repeat the convection test. Continue adjusting one recipe variable at a time until satisfactory results are achieved.

## Pan Placement Tips

- When using large (15" x 13") flat pans or trays that cover most of the rack, rack positions 2 or 3 produce the best results.
- When baking on more than one rack, it is recommended to use one of the convection modes and the 2nd and 4th position or the 3rd and 5th position for more even baking. When baking on three racks, use any combination of positions 2, 3, 4, and 5 for more consistent results.
- Stagger pans in opposite directions when two racks and several pans are used in conventional bake. If possible, no pan should be directly above another.
- Allow 1 to 2 inches of air space around all sides of each pan for even air circulation.

**Single Rack Pan Placement**

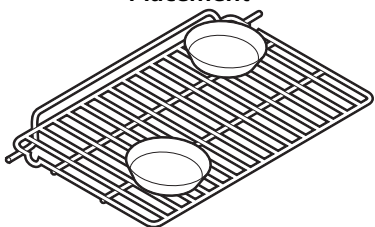

**Multiple Rack Pan Placement**

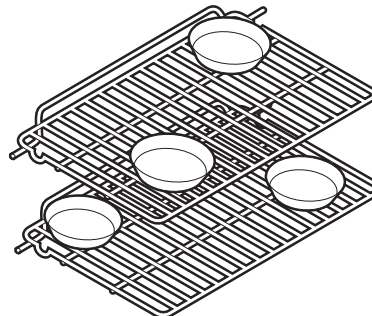

# Using the Oven

## BAKING / CONVECTION BAKING CHART

FOOD	PAN SIZE	POSITION	BAKE TEMP	BAKE TIME (MIN)	CONVENTIONAL BAKE TEMP	CONVECTION BAKE TEMP
<b>BREADS</b>						
Biscuits	Cookie sheet	3 or 4	400° F (204.4° C)	8 - 10	375° F (190.6° C)	7 - 9
Yeast loaf	Loaf pan	3 or 4	375° F (190.6° C)	30 - 35	350° F (176.7° C)	20 - 25
Yeast rolls	Cookie sheet	3 or 4	400° F (204.4° C)	12 - 15	375° F (190.6° C)	11 - 13
Nut bread	Loaf pan	3 or 4	375° F (190.6° C)	30 - 35	350° F (176.7° C)	20 - 25
Cornbread	8" x 8"	3 or 4	400° F (204.4° C)	20 - 25	375° F (190.6° C)	15 - 20
Gingerbread	8" x 8"	3 or 4	350° F (176.7° C)	35 - 40	325° F (162.8° C)	30 - 35
Muffins	Muffin tin	3 or 4	375° F (190.6° C)	15 - 20	350° F (176.7° C)	12 - 15
Corn muffins	Muffin tin	3 or 4	375° F (190.6° C)	15 - 20	350° F (176.7° C)	10 - 12
<b>CAKES</b>						
Angel food	Tube pan	3 or 4	375° F (190.6° C)	35 - 45	325° F (162.8° C)	30 - 35
Bundt	Tube pan	3 or 4	350° F (176.7° C)	45 - 55	325° F (162.8° C)	35 - 40
Cupcakes	Muffin pan	3 or 4	350° F (176.7° C)	16 - 20	325° F (162.8° C)	15 - 17
Layer, sheet	13" x 9"	3 or 4	350° F (176.7° C)	40 - 50	325° F (162.8° C)	30 - 32
Layer, two	9" round	3 or 4	350° F (176.7° C)	30 - 35	325° F (162.8° C)	25 - 30
Pound	Loaf pan	3 or 4	350° F (176.7° C)	60 - 65	325° F (162.8° C)	5 - 50
<b>COOKIES</b>						
Brownies	13" x 9"	3 or 4	350° F (176.7° C)	25 - 30	325° F (162.8° C)	20 - 25
Choc. chip	Cookie sheet	3 or 4	375° F (190.6° C)	12 - 15	350° F (176.7° C)	7 - 10
Sugar	Cookie sheet	3 or 4	350° F (176.7° C)	10 - 12	325° F (162.8° C)	9 - 10
<b>PASTRY</b>						
Cream puffs	Cookie sheet	3 or 4	400° F (204.4° C)	30 - 35	375° F (190.6° C)	24 - 27
<b>PIES</b>						
Crust, unfilled	9" round	3 or 4	425° F (218.3° C)	10 - 12	400° F (204.4° C)	7 - 9
Crust, filled	9" round	3 or 4	375° F (190.6° C)	55 - 60	350° F (176.7° C)	50 - 55
Lemon meringue	9" round	3 or 4	350° F (176.7° C)	12 - 15	325° F (162.8° C)	4 - 5
Pumpkin	9" round	3 or 4	350° F (176.7° C)	40 - 45	325° F (162.8° C)	35 - 45
Custard	6 - 4 oz cups	3 or 4	350° F (176.7° C)	35 - 40	325° F (162.8° C)	30 - 35
<b>ENTREES</b>						
Egg rolls	Cookie sheet	3 or 4	400° F (204.4° C)	12 - 15	375° F (190.6° C)	8 - 10
Fish sticks	Cookie sheet	3 or 4	425° F (218.3° C)	18 - 21	400° F (204.4° C)	13 - 16
Lasagna, frz	Cookie sheet	3 or 4	375° F (190.6° C)	65 - 70	350° F (176.7° C)	60 - 65
Pot pie	Cookie sheet	3 or 4	400° F (204.4° C)	35 - 40	375° F (190.6° C)	10 - 12
Gr. peppers stuffed	13" x 9"	3 or 4	375° F (190.6° C)	65 - 70	350° F (176.7° C)	45 - 50
Quiche	9" round	3 or 4	400° F (204.4° C)	25 - 30	375° F (190.6° C)	20 - 25
Pizza, 12"	Cookie sheet	3 or 4	400° F (204.4° C)	15 - 20	375° F (190.6° C)	10 - 12
Mac. & cheese, frz	Cookie sheet	3 or 4	375° F (190.6° C)	60 - 65	350° F (176.7° C)	45 - 50
<b>VEGETABLES</b>						
Baked potatoes	On rack	3 or 4	375° F (190.6° C)	60 - 65	350° F (176.7° C)	45 - 50
Spinach souffle	1 qt. casserole	3 or 4	350° F (176.7° C)	45 - 50	375° F (190.6° C)	35 - 40
Squash	Cookie sheet	3 or 4	375° F (190.6° C)	50 - 55	350° F (176.7° C)	40 - 45
French fries	Cookie sheet	3 or 4	425° F (218.3° C)	15 - 20	400° F (204.4° C)	10 - 15

**Note: The above information is given as a guide only.**

# Using the Oven

## Convection Roast

Convection Roast uses the same heating elements as Roast. However, unlike Convection Bake, Convection Roast utilizes the convection fan and heater in the back of the oven to help heat and circulate the air throughout the cook cavity.

As a general rule, items cook about 33% faster under Convection Roast. The temperature should be reduced by 25° F.

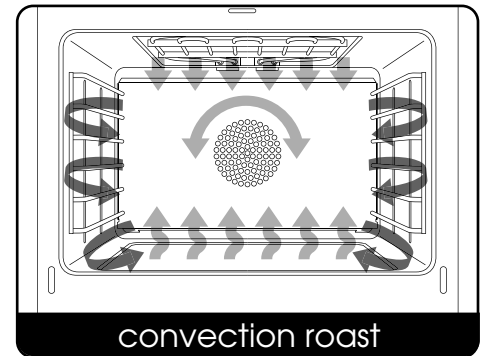

## Roasting Tips

ALWAYS use a broiler pan and grid when roasting. The hot air must be allowed to circulate around the item being roasted. DO NOT cover what is being roasted. Convection roasting seals in juices quickly for a moist, tender product. Poultry will have a light, crispy skin and meats will be browned, not dry or burned. Cook meats and poultry directly from the refrigerator. There is no need for meat or poultry to stand at room temperature.

- As a general rule, to convert conventional recipes to convection recipes, reduce the temperature by 25°F (-3.9°C) and the cooking time by approximately 10 to 15%.
- ALWAYS roast meats fat side up in a shallow pan using a roasting rack. No basting is required when the fat side is up. DO NOT add water to the pan as this will cause a steamed effect. Roasting is a dry heat process.
- Poultry should be placed breast side up on a rack in a shallow pan. Brush poultry with melted butter, margarine, or oil before and during roasting.
- For convection roasting, DO NOT use pans with tall sides as this will interfere with the circulation of heated air over the food.
- If using a cooking bag, foil tent, or other cover, use the conventional bake setting rather than either convection setting.
- When using a meat thermometer, insert the probe halfway into the center of the thickest portion of the meat. (For poultry, insert the thermometer probe between the body and leg into the thickest part of the inner thigh.) The tip of the probe should not touch bone, fat, or gristle to ensure an accurate reading. Check the meat temperature halfway through the recommended roasting time. After reading the thermometer once, insert it 1/2 inch (1.3 cm) further into the meat, then take a second reading. If the second temperature registers below the first, continue cooking the meat.
- Roasting times ALWAYS vary according to the size, shape and quality of meats and poultry. Less tender cuts of meat are best prepared in the conventional bake setting and may require moist cooking techniques. Remove roasted meats from the oven when the thermometer registers 5°F (-15°C) to 10°F (-12°C) lower than the desired doneness. The meat will continue to cook after removal from the oven. Allow roasts to stand 15 to 20 minutes after roasting in order to make carving easier.

For many foods, especially roasts and poultry, internal food temperature is the best test for doneness. The meat probe takes the guesswork out of roasting by cooking foods to the exact doneness you want.



## CONVECTION ROAST CHART

FOOD	WEIGHT	TEMP	TIME (MIN/LB)	INTERNAL TEMP
<b>BEEF</b>				
Rib Roast				
Rare	4-6 lbs	325° F (162.8° C)	23	140° F (60.0° C)
Medium	4-6 lbs	325° F (162.8° C)	25	155° F (68.3° C)
Well Done	4-6 lbs	325° F (162.8° C)	30	170° F (76.7° C)
Rump Roast				
Medium	4-6 lbs	325° F (162.8° C)	20	155° F (68.3° C)
Well Done	4-6 lbs	325° F (162.8° C)	24	170° F (76.7° C)
Top Roast				
Medium	3-4 lbs	325° F (162.8° C)	30	155° F (68.3° C)
Well Done	3-4 lbs	325° F (162.8° C)	35	170° F (76.7° C)
<b>LAMB</b>				
Lamb Leg	3-5 lbs	325° F (162.8° C)	30	180° F (82.2° C)
<b>PORK</b>				
Pork Loin	3-5 lbs	325° F (162.8° C)	30	180° F (82.2° C)
Pork Chop - 1" thick	1-1/4 lbs	325° F (162.8° C)	45 - 50 total time	N/A
Ham, fully cooked	5 lbs	325° F (162.8° C)	15	140° F (60.0° C)
<b>POULTRY</b>				
Chicken, Whole	3-4 lbs	350° F (176.7° C)	25	180° F (82.2° C)
<b>Turkey, unstuffed</b>	12-16 lbs	325° F (162.8° C)	11	180° F (82.2° C)
Turkey, unstuffed	20-24 lbs	325° F (162.8° C)	11	180° F (82.2° C)
Turkey, stuffed	12-16 lbs	325° F (162.8° C)	9-10	180° F (82.2° C)
Turkey, stuffed	20-24 lbs	325° F (162.8° C)	9-10	180° F (82.2° C)
Turkey Breast	4-6 lbs	325° F (162.8° C)	20	180° F (82.2° C)

**Note: The above information is given as a guide only.**

# Using the Oven

## Meat Probe Function

Meat probe function is only available in the upper oven.

The meat probe takes the guesswork out of roasting by cooking foods to the ideal internal temperature. The probe temperature setting is used to notify the user when the internal temperature of the meat being roasted is reached.

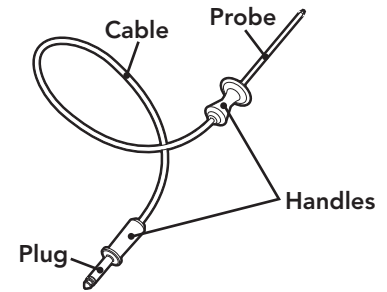

To Set the Automatic Probe Function

1. Insert probe into the meat and slide into oven.
2. Plug the probe into the outlet located on right interior wall of the oven and close oven door.
3. Select desired cooking function - set temperature and probe temperature.
4. When internal temperature is reached, the oven will beep and shut-off.

*Note:* It is recommended to set the internal temperature about 10 degrees lower than actual desired internal temperature. The meat will continue to cook when removed from the oven and will reach desired internal temperature while "standing".



## Tips for Using the Meat Probe

Use of probes other than the one provided with this product may result in damage to the probe. Use the handles of the probe and plug when inserting and removing them from the meat and outlet.

- To avoid damaging your probe, do not use tongs to pull on the cable when removing.
- To avoid breaking the probe, make sure food is completely defrosted before inserting.
- To prevent possible burns, do not unplug the probe from the outlet until the oven has cooled.
- Never leave the probe inside the oven during a self-cleaning cycle.
- Do not store the probe in the oven.

After preparing the meat and placing on broiler pan, follow these steps for proper probe placement.

- Lay the probe on the outside of the meat along the top or side and mark with your finger where the edge of the meat comes to on the probe. The point should rest in the center of the thickest meaty part of the roast.
- Insert the probe completely into the meat. It should not touch the bone, fat, or gristle. For roasts with no bone, insert the probe into the meatiest part of the roast. For bone-in ham or lamb, insert the probe into the center of the lowest large muscle or joint. Insert the probe into the meatiest part of the inner thigh from below and parallel to the leg of a whole turkey.
- When setting the probe temperature, it is recommended to set the temperature about 10°F (4°C) lower than desired internal temperature. The meat will continue to cook when removed from the oven and will reach the desired doneness while "standing".

# Using the Oven

Broiling directly exposes food to radiant heat (as over a fire or on top of a grill). The heat is direct and intense, and it differs from baking or roasting in that only the top side of the food is exposed to the heat source.

Conventional broiling (LO, MED or HI BROIL) is most successful for cuts of meat 1-2 inches thick and is also more suitable for flat pieces of meat. Convection broiling has the advantage of broiling food slightly quicker than conventional. Convection broiling of meats produces better results, especially for thick cuts. The meat sears on the outside and retains more juices and natural flavor inside with less shrinkage.

## CONV BROIL (Convection Broil)

The top element operates at full power. This function is exactly the same as regular broiling with the additional benefit of air circulation by the motorized fan in the rear of the oven. Smoke is reduced since the airflow also reduces peak temperatures on the food. Use this setting for broiling thick cuts of meats.

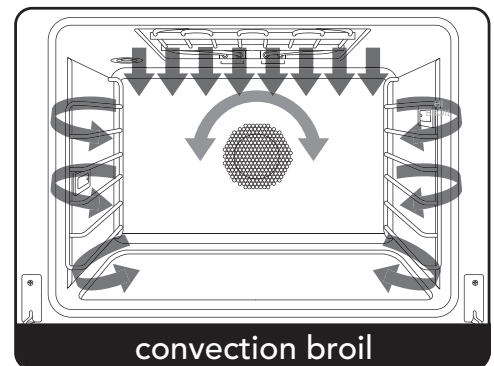

## HI BROIL

Heat radiates from both broil elements, located in the top of the oven cavity, at full power. The distance between the foods and the broil elements determines broiling speed. For fast broiling, food may be as close as 2 inches (5 cm) to the broil element. Fast broiling is best for meats where rare to medium doneness is desired. Use this setting for broiling small and average cuts of meat.

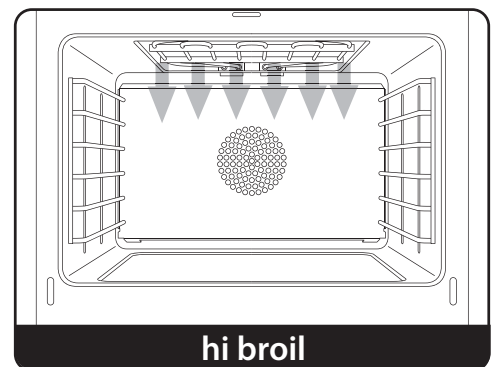

## MED BROIL

Inner and outer broil elements pulse on and off to produce less heat for slow broiling. Allow about 4 inches (10 cm) between the top surface of the food and the broil element. Slow broiling is best for chicken and ham in order to broil food without over-browning it. Use this setting for broiling small and average cuts of meat.

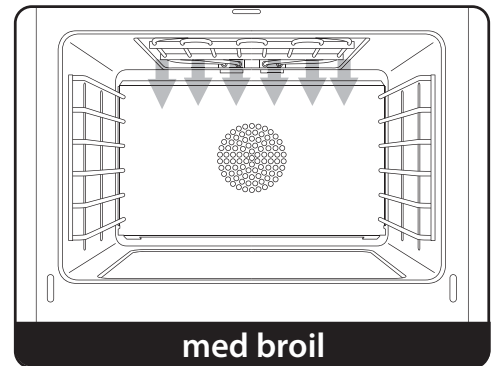

## LOW BROIL

This mode uses only a fraction of the available power to the inner broil element for delicate top-browning. The inner broil element is on for only part of the time. Use this setting to gently brown meringue on racks 3 or 4 in 3-4 minutes.

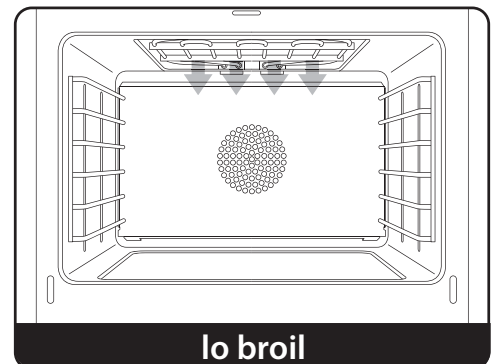

# Using the Oven

## Broiling Tips

- ALWAYS use a broiler pan and grid for broiling. They are designed to provide drainage of excess liquid and fat away from the cooking surface to help prevent splatter, smoke, and fire.
- To keep meat from curling, slit fatty edge.
- Brush chicken and fish with butter several times as they broil to prevent drying out. To prevent sticking, lightly grease broiler tray.
- Broil on first side for slightly more than half the recommended time, season, and turn. Season second side just before removing.
- ALWAYS pull rack out to stop position before turning or removing food.
- Use tongs or a spatula to turn meats. NEVER pierce meat with a fork, as this allows the juices to escape.
- Remove the broiler pan from the oven when you remove the food. Drippings will bake onto the pan if it is left in the heated oven after broiling. While pan is hot, place damp paper towel over grid. Drizzle with liquid dishwashing detergent and pour water over grid. This will make cleaning of the pan easier, or the broiler pan can be lined with aluminum foil to make cleaning easier. Be sure the foil extends up the side of the pan. Although it is not recommended, the grid can also be covered with foil. Be sure to slit openings to conform with the openings in the grid so melted fat can drain through to prevent spattering, smoking, or the possibility of grease fire.

**BROILING CHART**

FOOD	WEIGHT	SETTING	RACK	TIME (MIN)
<b>BEEF</b>				
Sirloin, 1"				
Rare	14 oz	HI Broil	4 or 5	8-10
Medium	14 oz	HI Broil	4 or 5	10-12
Well Done	14 oz	HI Broil	4 or 5	11-13
T-Bone, 3/4"				
Rare	10 oz	HI Broil	4 or 5	7-8
Medium	10 oz	HI Broil	4 or 5	9-10
Well Done	10 oz	HI Broil	4 or 5	11-12
Hamburger, 1/2"				
Rare	1/4 lbs	HI Broil	4 or 5	6-7
Medium	1/4 lbs	HI Broil	4 or 5	7-8
Well Done	1/4 lbs	HI Broil	4 or 5	8-9
<b>LAMB</b>				
Rib Chops, 1"	12 oz	Convection Broil	3 or 4	7
Shoulder	1 lb	Convection Broil	3 or 4	6
<b>PORK</b>				
Pork Loin Chops, 3/4"	1 lb	Convection Broil	3	14
Bacon		Med Broil	4	6
<b>POULTRY</b>				
Bnls Breast, 1"	1/2 lb	Med Broil	4 or 5	15-20
<b>Bnls Breast, 1"</b>	1/2 lb	Convection Broil	3 or 4	25-30
Bone in Breast	2-3 lbs	Med Broil	3 or 4	40-45
Bone in Breast	2-3 lbs	Convection Broil	3 or 4	25-30
Chicken Pieces	2-3 lbs	Med Broil	3 or 4	40-45
Chicken Pieces	2-3 lbs	Convection Broil	3	25-30
<b>FISH</b>				
Salmon Steak	1 lb	Med Broil	3	7
Fillet	1 lb	Med Broil	3 or 4	6

**Note: The above information is given as a guide only.**

# Cleaning and Maintenance

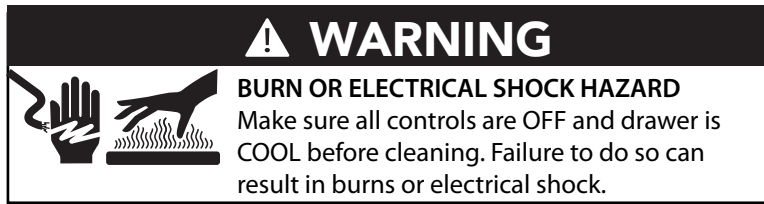

Any piece of equipment works better and lasts longer when maintained properly and kept clean. Cooking equipment is no exception. Your oven must be kept clean and maintained properly.

## Oven Surfaces

Several different finishes have been used in your electric oven. Cleaning instructions for each surface are given below. Your oven features a Self-Clean cycle for the oven interior. See "Self-Clean Cycle" for complete instructions. NEVER USE AMMONIA, STEEL WOOL PADS OR ABRASIVE CLOTHS, CLEANSERS, OVEN CLEANERS, OR ABRASIVE POWDERS. THEY CAN PERMANENTLY DAMAGE YOUR OVEN.

## Control Knobs

MAKE SURE ALL THE CONTROL KNOBS POINT TO THE OFF POSITION BEFORE REMOVING. Pull the knobs straight off. Wash in detergent and warm water. Dry completely and replace by pushing firmly onto stem.

## Stainless Steel Parts

Some stainless steel parts may have a protective wrap, which must be peeled off. All stainless steel body parts should be wiped regularly with hot, soapy water at the end of each cooling period and with liquid cleaner designed for this material when soapy water will not do the job. If build-up occurs, DO NOT use steel wool, or abrasive cloths, cleaners, or powders. If it is necessary to scrape stainless steel surface to remove encrusted material, soak area with hot, wet towels to loosen the material, then use a wooden or nylon spatula or scraper. DO NOT use a metal knife, spatula, or any other metal tool to scrape stainless steel surfaces. Scratches are almost impossible to remove.

## Oven Racks

Clean with detergent and hot water. Stubborn spots can be scoured with a soap-filled steel wool pad. DO NOT CLEAN THE OVEN RACKS USING THE SELF-CLEAN CYCLE. They could sustain damage due to the extreme heat of the Self-Clean cycle.

## Meat Probe

The meat probe may be cleaned with soap and water or a soap-filled scouring pad. Cool the probe before cleaning. Scour stubborn spots with a soap-filled scouring pad, rinse and dry.

- Do not immerse the meat probe in water.
- Do not store the probe in the oven.

# Self-Cleaning

## ⚠ CAUTION



Do not touch the exterior portions of the oven after self-cleaning cycle has begun, since some parts become extremely hot to the touch! During the first few times the self-cleaning feature is used, there may be some odor and smoking from the curing of the binder in the high-density insulation used in the oven. When the insulation is thoroughly cured, this odor will disappear. During subsequent self-cleaning cycles, you may sense an odor characteristic of high temperatures. Keep the kitchen well-vented during the self-cleaning cycle.

## ⚠ CAUTION

Due to the concealed heating element, **DO NOT** cover or line the bottom of the oven with foil.

## ⚠ WARNING

**DO NOT** use commercial oven cleaners inside the oven. Use of these cleaners can produce hazardous fumes or can damage the porcelain finishes.

**Note:** The upper and lower ovens **CANNOT** be self-cleaned at the same time.

Using heat up to 800° F, the oven will self-clean the inside of the cook cavity in 3 1/2 hours. To initiate a self-clean cycle:

1. Make sure the cook cavity is empty and remove the oven rack.  
**Note:** Failure to remove the oven rack will cause the rack to discolor.
2. Remove large particles and wipe standing liquids/grease.  
**Note:** Failure to remove large food particles and wipe the oven down may result in smoke while the oven is self-cleaning.
3. Select Self-Clean. As soon as self-clean is selected, self-clean in process will appear on the screen and oven will automatically begin self-clean process.
4. When the cleaning cycle is complete and the oven has returned to a safe temperature, the oven will beep and power off.

## ⚠ CAUTION

During the self-clean cycle, the oven door is locked and the oven surfaces can become very hot.

4. To immediately terminate a self-clean cycle, tap Cancel. Message will appear.



# Replacing Oven Lights

**⚠ WARNING**

**ELECTRICAL SHOCK HAZARD**  
 Disconnect the electric power at the main fuse or circuit breaker before replacing bulb.



**⚠ WARNING**

**ELECTRICAL SHOCK HAZARD**  
 DO NOT touch a hot oven light bulb with a damp cloth as the bulb could break. Should the bulb break, disconnect power to the appliance before removing bulb to avoid electrical shock



## Halogen Lights

1. Unsnap glass light cover using a screwdriver in the access groove.
2. Firmly grasp light bulb and pull out.
3. Replace with halogen bulb using volt and wattage requirements listed on glass cover.
4. Replace the light cover by snapping glass cover onto metal box.
5. Reconnect power at the main fuse or circuit breaker.

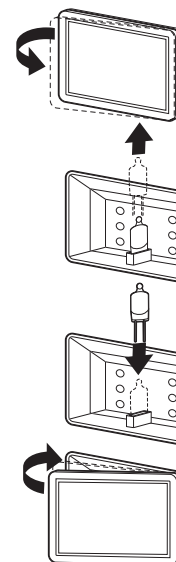

## Troubleshooting

Before calling for service, please consider the following troubleshooting guidelines.

Problem	Solution
Displays and indicator lights are not working.	Verify the oven is receiving power.
The touch screen display is too dark or light.	Adjust the display brightness.
Sounds are not working.	Verify the sound is turned on. Verify the volume is turned up.
Oven sounds are too loud or soft.	Adjust the volume.
The clock is set to the wrong time.	See Clock under the Utility menu.
The oven light bulb is burned out.	Call Customer Service at 1-888-(845-4641) to order a replacement bulb.  Instructions and all necessary components are included with each bulb.

**Note:** In the event that the oven displays an alert message that tells you to contact the Viking Range, LLC at 1-888-(845-4641). Before calling, take note of the failure alert displayed on the screen. This will help the service technician diagnose the potential problem in an efficient manner.

# Service Information

If service is required, call your authorized service agency.

Have the following information readily available.

- Model number
- Serial number
- Software Version
- Date purchased
- Name of dealer from whom purchased

Clearly describe the problem that you are having. If you are unable to obtain the name of an authorized service agency, or if you continue to have service problems, contact Viking Range, LLC at 1-888-(845-4641), or write to:

**VIKING RANGE, LLC  
PREFERRED SERVICE  
111 Front Street  
Greenwood, Mississippi 38930 USA**

Record the following information indicated below. You will need it if service is ever required.

The serial number and model number for your oven are located on the identification plate mounted on the bottom left side of the upper oven door opening.

To access the software version, click the three dots above the time, Select Utility, select Update.





Record the information indicated below. You will need it if service is ever required.

Model number \_\_\_\_\_

Serial number \_\_\_\_\_

Software version \_\_\_\_\_

Date of purchase \_\_\_\_\_

Date installed \_\_\_\_\_

Dealer's name \_\_\_\_\_

Dealer's Address \_\_\_\_\_

If service requires installation of parts, use only authorized parts to ensure protection under the warranty.

**KEEP THIS MANUAL FOR FUTURE REFERENCE.**

# Warranty

## PROFESSIONAL ELECTRIC WALL OVEN WARRANTY

### TWO YEAR FULL WARRANTY

Electric wall ovens and all of their component parts, **except as detailed below\*†**, are warranted to be free from defective materials or workmanship in normal residential use for a period of two (2) years from the date of original retail purchase or closing date for new construction, whichever period is longer. Viking Range, LLC, warrantor, agrees to repair or replace, at its option, any part which fails or is found to be defective during the warranty period.

**\*FULL NINETY (90) DAY COSMETIC WARRANTY:** Product is warranted to be free from cosmetic defects in materials or workmanship (such as scratches on stainless steel, paint/porcelain blemishes, etc.) for a period of ninety (90) days from the date of original retail purchase or closing date for new construction, whichever period is longer. Any defects must be reported to the selling dealer within ninety (90) days from date of original retail purchase. Viking Range, LLC uses high quality processes and materials available to produce all color finishes. However, slight color variation may be noticed because of the inherent differences in painted parts and porcelain parts as well as differences in kitchen lighting, product locations, and other factors. Therefore, this warranty does not apply to color variation attributable to such factors.

**†FULL NINETY (90) DAY WARRANTY IN "RESIDENTIAL PLUS" APPLICATIONS:** This full warranty applies to applications where use of the product extends beyond normal residential use, but the warranty period for products used in such applications is ninety (90) days. Examples of applications covered by this warranty are bed and breakfasts, fire stations, private clubs, churches, yachts, etc. Under this "Residential Plus" warranty, the product, its components and accessories are warranted to be free from defective material or workmanship for a period of ninety (90) days from the date of original retail purchase. This warranty excludes use of the product in all commercial locations such as restaurants, food service locations and institutional food service locations.

### FIVE YEAR LIMITED WARRANTY ON BURNERS AND ELEMENTS

Any bake element, broil element, or convection element which fails due to defective materials or workmanship (excluding cosmetic failures) in normal household use during the third through fifth year from the date of original retail purchase will be repaired or replaced, free of charge for the part itself, with the owner paying all other costs, including labor. This does not include ignition systems, burner bases, etc.

### TERMS AND CONDITIONS

This warranty extends to the original purchaser of the product warranted hereunder and to each transferee owner of the product during the term of the warranty and applies to products purchased and located in the United States and Canada. Products must be purchased in the country where service is requested. If the product or one of its component parts contains a defect or malfunction during the full warranty period after a reasonable number of attempts by the warrantor to remedy the defect or malfunction, the owner is entitled to either a refund or replacement of the product or its component part or parts. Replacement of a component part includes its free installation, except as specified under the limited warranty. Under the terms of this warranty, service must be performed by a factory authorized Viking Range, LLC service agent or representative. Service will be provided during normal business hours, and labor performed at overtime or premium rates shall not be covered by this warranty. Owner shall be responsible for proper installation, providing reasonable and necessary maintenance, providing proof of purchase upon request, and making the appliance reasonably accessible for service. The return of the Owner Registration Card is not a condition of warranty coverage.

You should, however, return the Owner Registration Card so that Viking Range, LLC can contact you should any question of safety arise which could affect you.

This warranty gives you specific legal rights, and you may also have other rights which may vary from jurisdiction to jurisdiction.

**WHAT IS NOT COVERED BY THIS WARRANTY:** This warranty shall not apply to damage resulting from abuse, failure to provide reasonable and necessary maintenance, accident, delivery, negligence, natural disaster, loss of electrical power to the product for any reason, alteration, outdoor use, improper installation, improper operation, or repair or service of the product by anyone other than an authorized Viking Range, LLC service agency or representative. This warranty does not apply to commercial usage.

### LIMITATION OF REMEDIES AND DURATION OF IMPLIED WARRANTY

**OWNER'S SOLE AND EXCLUSIVE REMEDY FOR A CLAIM OF ANY KIND WITH RESPECT TO THIS PRODUCT SHALL BE THE REMEDIES SET FORTH ABOVE. VIKING RANGE, LLC IS NOT RESPONSIBLE FOR CONSEQUENTIAL OR INCIDENTAL DAMAGE, INCLUDING BUT NOT LIMITED TO FOOD OR MEDICINE LOSS, DUE TO PRODUCT FAILURE, WHETHER ARISING OUT OF BREACH OF WARRANTY, BREACH OF CONTRACT OR OTHERWISE.** Some jurisdictions do not allow the exclusion or limitation of incidental or consequential damages, so the above limitation or exclusions may not apply to you. **ANY IMPLIED WARRANTIES OF MERCHANTABILITY OR FITNESS FOR A PARTICULAR PURPOSE APPLICABLE TO THIS PRODUCT ARE LIMITED IN DURATION TO THE PERIOD OF COVERAGE OF THE APPLICABLE EXPRESS WRITTEN LIMITED WARRANTIES SET FORTH ABOVE.** Some states do not allow limitations on how long an implied warranty lasts, so the above limitation may not apply to you.

### WARRANTY SERVICE

To obtain warranty service, contact an authorized Viking Range, LLC service agent, or Viking Range, LLC, 111 Front Street, Greenwood, Mississippi 38930, (888) 845-4641. Provide model and serial number and date of original purchase or closing date for a new construction. For the name of your nearest authorized Viking Range, LLC service agency, call Viking Range, LLC.

**IMPORTANT:** Retain proof of original purchase to establish warranty period.

**Specifications subject to change without notice.**



Viking Range, LLC  
111 Front Street  
Greenwood, Mississippi 38930 USA  
(662) 455-1200

For product information,  
call 1-888-(845-4641)  
or visit our web site at [vikingrange.com](http://vikingrange.com) in the US  
or [brigade.ca](http://brigade.ca) in Canada