

30" Electric Cooktop

Benchmark® Series – Black with Stainless Steel Frame NETP068SUC

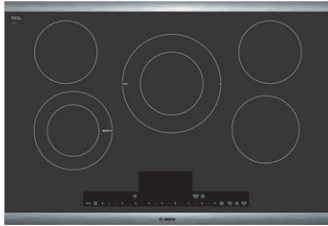

BOSCH
Invented for life



NETP068SUC

Black with Stainless Steel Frame

The Benchmark® series electric cooktop is sleek in design, and features AutoChef® technology which maintains precise cooking temperatures.

Features & Benefits

Five element cooktop features a 3,600 Watt dualzone center element.

AutoChef® maintains exact cooking temperatures for consistent results.

Each zone's timer automatically shuts off when cooking is done.

SpeedBoost® offers shorter heat-up times for liquids.

PreciseSelect® offers 17 different direct cooking level settings.

Element Performance

Power of Front Left heating element	2,000 / 800 W
Power of Back Left heating element	1,200 W
Power of Center heating element	3,600 / 1,400 W
Power of Back Right heating element	1,200 W
Power of Front Right heating element	1,500 W

Element Size

Dimension of Front Left heating element	7", 5"
Dimension of Back Left heating element	6"
Dimension of Center heating element	9", 6"
Dimension of Back Right heating element	6"
Dimension of Front Right heating element	7"

Technical Details

Watts	9,000 W
Circuit breaker	40 A
Volts	208-240 V
Frequency	60 Hz
Plug type	No plug
Energy source	Electric

Dimensions & Weight

Overall appliance dimensions (HxWxD)	1/4" +4" x 31" x 21 1/4"
Required cutout size (HxWxD)	4" x 28 7/8" x 20"
Minimum distance from counter front	2 1/4"
Minimum distance from rear wall	2"
Net weight	32 lbs

Accessories – Optional



HEZ390210
8" AutoChef® pan



HEZ390220
9" AutoChef® pan



HEZ390230
10" AutoChef® pan



Accessories: To purchase Bosch accessories, cleaners & parts please visit www.bosch-home.com/us/store or call 1-800-944-2904 (Mon to Fri 5 am to 6 pm PST, Sat 6 am to 3 pm PST).

Notes: All height, width and depth dimensions are shown in inches. BSH reserves the absolute and unrestricted right to change product materials and specifications, at any time, without notice. Consult the product's installation instructions for final dimensional data and other details prior to making cutout.

Warranties: Please see Use & Care manual or Bosch website for statement of limited warranty.

For more information on our entire line of products, go to www.bosch-home.com/us or call 1-800-944-2904

© BSH Home Appliances Corporation. All rights reserved. Bosch is a registered trademark of Robert Bosch GmbH.

30" Electric Cooktop

Benchmark® Series – Black with Stainless Steel Frame NETP068SUC

Installation Details

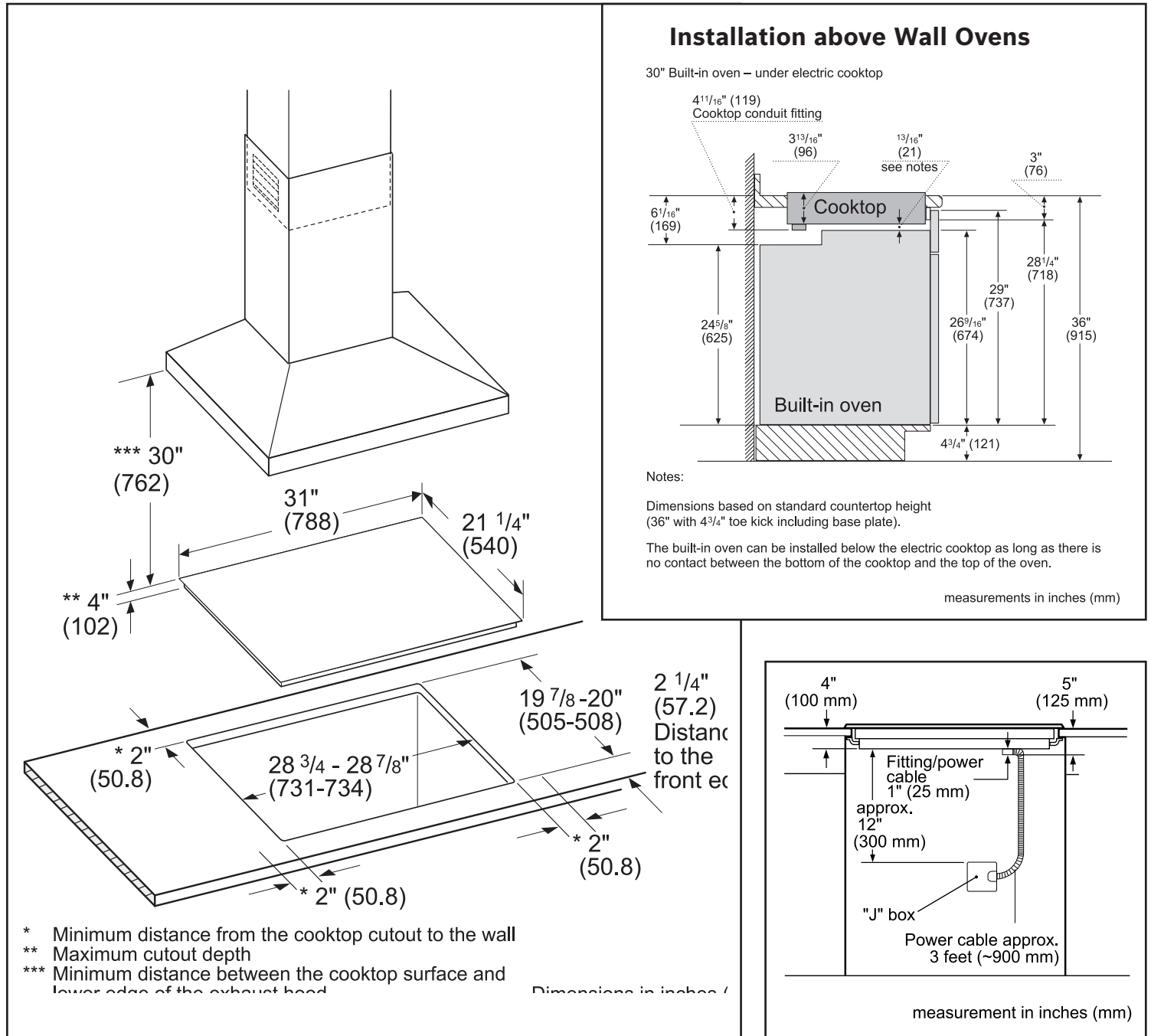

Accessories: To purchase Bosch accessories, cleaners & parts please visit www.bosch-home.com/us/store or call 1-800-944-2904 (Mon to Fri 5 am to 6 pm PST, Sat 6 am to 3 pm PST).

Notes: All height, width and depth dimensions are shown in inches. BSH reserves the absolute and unrestricted right to change product materials and specifications, at any time, without notice. Consult the product's installation instructions for final dimensional data and other details prior to making cutout.

Warranties: Please see Use & Care manual or Bosch website for statement of limited warranty.

For more information on our entire line of products, go to www.bosch-home.com/us or call 1-800-944-2904

© BSH Home Appliances Corporation. All rights reserved. Bosch is a registered trademark of Robert Bosch GmbH.