



48-INCH HOOD LINER

DHD48U790L



AVAILABLE MODELS

DHD48U790LS Silver Stainless

FEATURES & BENEFITS

- Four-speed fan provides great performance while minimizing noise.
- Dishwasher-friendly baffles for easy cleanup.
- Strip LED lighting provides energy efficiency and a bright cooking area.
- Auto-On turns hood on automatically if high temperatures are sensed.
- Internal blower for easy installation.
- Noise dampening system provides a quieter experience.

CONTROL FEATURES

FAN SPEEDS	4 (3 STEP + BOOSTER)
CONTROL TYPE	KNOBS
AUTO SENSING	YES (HEAT SENSOR)
LOCATION	FRONT - CENTER

ADDITIONAL FEATURES

FILTER TYPE	PROFESSIONAL BAFFLE
REMOVABLE FILTER	YES
LIGHTING	STRIP LED OF 39-3/8"

PERFORMANCE

CFM	1,200 CFM (780 CFM)
-----	---------------------

TECHNICAL DETAILS

CIRCUIT BREAKER (A)	15
VOLTS (V)	120
FREQUENCY (HZ)	60
ENERGY SOURCE	ELECTRIC

DIMENSIONS & WEIGHT

APPLIANCE DIMENSIONS (W X H X D) (IN.)	48 X 5-7/16 X 22
--	------------------

WARRANTY

LIMITED, PARTS AND LABOR	2 YEARS
--------------------------	---------

dacor 48-INCH HOOD LINER

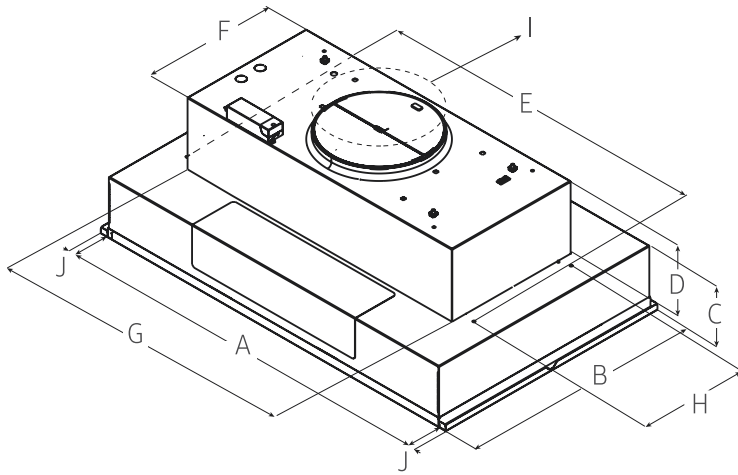

APPLIANCE DIMENSIONS

48"

A	46-1/2" (117.8 CM)
B	22" (55.9 CM)
C	5-7/16" (13.8 CM)
D	6-1/2" (16.4 CM)
E	27-9/16" (70 CM)
F	12-7/16" (31.4 CM)
G	29-13/16" (75.7 CM)
H	10-1/8" (25.7 CM)
I	10" (25.4 CM)
J	3/4" (1.9 CM)

®/™ © 2022. Dimensions are for planning purposes only. For complete details, see Installation Instructions packed with product. Specifications subject to change without notice. For product questions, visit www.dacor.com or call Customer Assurance at (833) 83-ELITE.

Appliance must be enable iQ Control. Wi-Fi & SmartThings* app required. Compatible smart appliance required. Features subject to change. Details and privacy info at <https://www.dacor.com/about-us/privacy-policy>.