

ACCENTO PROFESSIONAL 36"

36" ALL GAS PROFESSIONAL RANGE



CODE ID



F4PGR366S1



Heavy Duty Grates



Continuous Grate Surface



Dual Crescendo Burner



Dual Convection



Cool Touch Door



Multi-level cooking



Digital minute minder

COLOR KIT

	STAINLESS STEEL
	MATTE BLACK RAL 9004
	MATTE WHITE RAL 9016
	GLOSSY RED RAL 3003

OPTIONAL ACCESSORIES

ACDKIT36 ...	Colour kit
FMWOK	Wok ring
FMSIM	Simmer plate
F6BG36BCI	Island trim
F6BG36STD	Standard trim
F6BG36HBT	High back trim
FMGRID36	Griddle
FMTRP36	Telescopic rack

COOKING SURFACE

3 Heavy Duty, continuous cast iron grates
One piece, matte finish porcelain burner bowl
3 Dual-Flame Crescendo Burners
3 X 18,000 BTU max (NG)
3 Rapid Burners
3 X 15,000 BTU max (NG)
Natural Gas (LP convertible)

OVEN

Dual Convection
Black Porcelain enamel interior
Cool to touch door
Extra-large baking cavity and viewing area
3 Halogen lights for flawless visibility
Gross capacity 5.7 cu. ft.
2 chromed racks
Enameled Grill set

OVEN FUNCTIONS

Bake
Broil
Convection
Pizza cooking
Dehydrate
Timer

ACCENTO

36" ALL GAS PROFESSIONAL RANGE

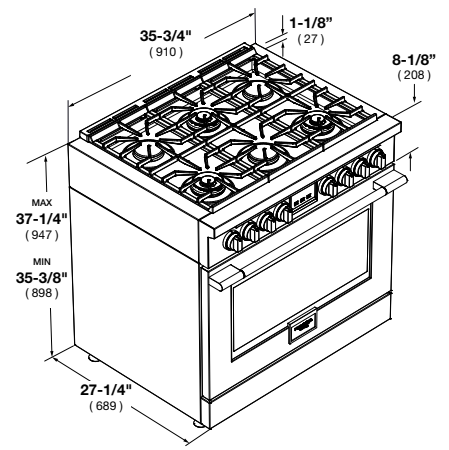

CODE ID	F4PGR366S1 - 36" FULL GAS PROFESSIONAL RANGE		
Series and Finish	400 Series - Professional Design - Stainless Steel		
CONTROL PANEL			
Control Type	Valve		
Clock Display	•		
COOKTOP			
Cooking Surface	Matte Black Enameled		
Type	GAS (NG or LP)		
GAS COOKTOP FEATURES			
	Electric Flame and Re-ignition	Top Mount Injectors	Dual Crown Brass Burner
	Flame-out sensing	L.P. Conversion Kit	Pressure Regulator
Heavy Duty Cast Iron Grates	3		
Cooking Zones	6		
Burners types	Dual Flame/Rapid Burners		
Power Front L+R (Max/Min) G20 - 5" (NG)	18000 (BTU/h) - 5300W / 950 (BTU/h) - 275W		
Power Rear L+R (Max/Min) G20 - 5" (NG)	15000 (BTU/h) - 4400W / 2200 (BTU/h) - 645W		
Power Front Middle (Max/Min) G20 - 5" (NG)	15000 (BTU/h) - 4400W / 2200 (BTU/h) - 645W		
Power Rear Middle (Max/Min) G20 - 5" (NG)	18000 (BTU/h) - 5300W / 950 (BTU/h) - 275W		
Power Front L+R (Max/Min) G31 - 10" (LP)	15000 (BTU/h) - 4400W / 950 (BTU/h) - 275W		
Power Rear L+R (Max/Min) G31 - 10" (LP)	12000 (BTU/h) - 3500W / 2200 (BTU/h) - 645W		
Power Front Middle (Max/Min) G31 - 10" (LP)	12000 (BTU/h) - 3500W / 2200 (BTU/h) - 645W		
Power Rear Middle (Max/Min) G31 - 10" (LP)	15000 (BTU/h) - 4400W / 950 (BTU/h) - 275W		
OVEN			
Type	Multifunction 2 Fans (True Euro Conv.)		
Temperature Regulation	Thermostat		
Injection Oven	T-Zero		
OVEN FUNCTIONS			
	Pizza (Lower Convection)	Down Bake	Broil
GAS OVEN FEATURES			
	Electronic Flame Ignition	Gas safety devices	L.P. Conversion Kit
	Flame-out Sensing		
OVEN DOOR(S)			
Oven Glass Window	Deep Embossed Window		
Door Cooling System	4 Pane Heat Resistant Glasses		
Door Hinges	Heavy Duty Steady Tilt		
Handle Style	Stainless Steel Tube d30mm, Metal terminals		
OVEN CAVITY			
Gross Capacity (cbft)	5.7		
Cavity Enamel Colour	Black		
Rack Positions	6		
Oven Lights	3x20W Halogen		
BOTTOM BURNER			
Power (Max) G20 - 5"	21500 (BTU/h) - 6300W		
Power (Max) G31 - 10"	21500 (BTU/h) - 6300W		
GRILL BURNER			
Power (Max) NG	18000 (BTU/h) - 5300W		
Power (Max) LP	17000 (BTU/h) - 5000W		
OVEN ACCESSORIES			
Chromed Racks	2 racks without frontal bend		
Enameled Grill set (basin + anti splash)	1		
Telescopic Chromed Rack	only as optional ACCESSORY		
DIMENSIONS/WEIGHT			
Overall dim - Width	29 - 3/4"	(758 mm)	
Overall dim - Height (min - max)	39"	(993 mm)	
Overall dim - Depth	29 - 3/4"	(756 mm)	
POWER / RATINGS (120 V, 60 HZ)			
KW/Amps rating rating at 120V, 60Hz	200W - 1.7A		
Cable + Plug	Nema 5-15P		
INSTRUCTIONS FOR USE			
Use & Care Manual / Installation Manual	English / French / Spanish		