

SOFIA 48" PRO RANGE

















CODE ID

SOFIA 48" PRO INDUCTION RANGE - ALL GLASS



F6PIR487S1



-  Easy Clean Ceramic Glass
-  Dual Max Power
-  Bridge Zone
-  Power Boost Burner
-  Pan Detection system
-  Residual Heat Sensor
-  Dual True Convection (main oven)
-  Single True Convection (accessory oven)
-  Soft Closing Door
-  Self Clean Oven
-  1 Telescopic Rack
-  Cool Touch Door
-  Digital Controls
-  Meat Probe
-  Fast Pre-Heat

SUMMARY DESCRIPTION

This elegantly designed 48" induction range is our first all-electric pro range alternative for those who do not have access to gas or choose to go full electric. The cooking surface features 7 powerful premium European inductors under a continuous piece of ceramic glass adding to the elegant design. Not only does this layout feature the same beloved configuration of our 36" induction range but includes a dedicated bridge element, which when put into bridge function, allows one to combine both induction zones into one large zone for use with specialty cookware or an induction-capable griddle. The instant response and precise control of the induction are ensured by the presence of professional control knobs. Below the cooking surface, two self-cleaning true convection ovens with intuitive multiple baking and broiling functions and the convenience of telescoping racks encourage you to cook the way you want.

COLOR KIT

	STAINLESS STEEL	GLOSSY WHITE	RAL 9016	
	MATTE BLACK RAL 9004	MATTE WHITE	RAL 9016	
	GLOSSY BLACK RAL 9004	MATTE GREY	RAL 9007	
	GLOSSY RED RAL 3003			

OPTIONAL ACCESSORIES

PDRKIT48 ...	Color kit
F6BG48STD	Standard trim
F6BG48HBT	High back trim
F6BG48BCI	Island trim
FMTRP30	Telescopic rack
FMTRP18	Telescopic rack

SPECIFICATIONS

COOKING SURFACE

Seven powerful premium European inductors
 4 Single Induction cooking zones
 1 Dual Max Power with Ø 11" cooking zone
 2 Bridge Zone Elements (griddle function)
 Elegant Ceramic glass surface
 Booster function for each cooking zone
 Residual heat and Power-on Indicators
 Digital Minute Minder / Pot Detection System
 Child Lock Function
 Automatic Heat-up

OVEN

Dual True Convection in main oven and
 True Convection in accessory oven
 Self-cleaning oven with Multifunction baking
 Black Porcelain enamel interior
 Cool to the touch soft closing doors
 Extra-large baking cavity and viewing area
 3 Halogen lights on main oven
 2 Halogen light on accessory oven
 2 Chrome racks per oven
 1 Telescopic rack per oven
 1 Meat probe
 Gross capacity 4.4 cu. ft. and 2.7 cu.ft

OVEN FUNCTIONS

Bake
 Broil
 Roast
 True Convection
 Warm / Proof / Dehydrate
 Meat Probe
 Self-Clean
 Sabbath Mode
 Convection Roast

SOFIA 48" PRO RANGE

SOFIA 48" PRO INDUCTION RANGE - ALL GLASS

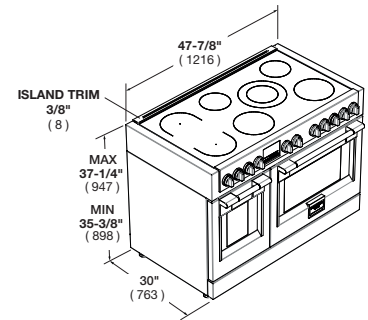

CODE ID		F6PIR487S1	
Series - Stainless Steel Aesthetics		Sofia Full Electric 48" - Professional	
COOKTOP			
Type		Induction	
Cooking Surface		Ceramic Glass	
Knobs		7 Knobs	
Induction Special Features			
		Pot Detection System	Child lock function
		Cooling fan system	
Power management with indication		Main dual burner and griddle power unaffected	
INDUCTION CONTROL FEATURES			
Power levels 1 to 9		Simmer Function 205°F / 95°C (inside the pot 195°F / 90°C) only available on bridge or griddle left zones	
		Digital display for power level indication	Melting Function 113°F / 45°C inside the pot 108°F / 42°C
		Warming Function 158°F / 70°C inside the pot 149°F / 65°C	Booster/Fast boil function for each zone
		Heat up time automatic	Residual heat indication
		Knob for power setting	
		5 + 2 Bridge zone elements (griddle function)	
Front Left	Power L9 Booster	Inductor 9" (230mm)	2300W 3700W
Rear Left	Power L9 Booster	Inductor 7" (180mm)	1850W 3000W
Middle dual circuit	Power L9 Booster	Inductor 11" (280mm)	3000W 5500W
Middle single circuit	Power L9 Booster	Inductor 7" (180mm)	1850W 2600W
Front Right	Power L9 Booster	Inductor 9" (230mm)	2300W 3700W
Rear Right	Power L9 Booster	Inductor 7" (180mm)	1850W 3000W
Bridge Front + Rear Left	Power L9 Booster	2 x Inductor 7" (180mm)	2 x 1850W 3000W
OVEN			
Type - Oven Type - Temperature Regulation		ELECTRIC PIRO - Various (see explanation of codes) - Electronic	
Functions			
		Pyrolytic Self-Clean with automatic door latch	True European Convection Bake (Multi level)
		Convection Broil	Convection Roast
		Pizza (Convection bake)	Bake
		Broil	Dehydrate
		Thaw (Defrost)	Proof (Warm)
		Keep warm (Warm Plus)	Oven Lights
		Fast Preheat	
Control Panel			
Control type		Modular LED - Electronic	
Clock, Temperature, Function Display		LED	
Commands - Language		4 Knobs / 6 Touch Keys - English	
Electric Oven Features			
		Preset/Last used temperature memory	Preheat gauge (25%, 50%, 75%, 100%)
		Automatic Fast Preheat	Child Door Lock
		Commands Lock	Sabbath mode
		12/24 hours clock format	°C/°F degree unit
Oven Door(s)			
Oven Glass Window		Deep Embossed Window	
Door Cooling System		4 Pane Heat Resistant (cool touch) Glass	
Soft closing system			
Door Hinges		Heavy Duty Steady Tilt	
Handle style		Stainless Steel Tube d30mm, metal end caps	
Oven Cavity			
		18" OVEN	30" OVEN
Net Capacity (cbft)		2.4	4.1
Cavity Enameling Colour		Black	Black
Rack Positions		6	6
Oven Lights		2x20W Halogen	
Heating Element			
		Broil Upper Heating Element 2100 W (240V)	Broil Upper Heating Element 3500W (240V)
		Upper Auxiliary Element Wattage 700 W (240V)	Upper Auxiliary Element Wattage 1032W (240V)
		Concealed Bake Heating Element 1750 W (240V)	Concealed Bake Heating Element 3000W (240V)
		Convection Element Wattage 1x2500 W (240V)	Convection Element Wattage 2x1300W (240V)
Oven Accessories			
		Chromed racks (2)	
		Telescopic chromed rack	
		Meat probe	
DIMENSIONS WEIGHTS			
Overall dim - Width Height Depth		47 7/8" (1216mm) 35 3/8" to 37 1/4" (898 - 947mm) 30" (763mm)	
Gross weight Net weight		204,4 kg - 450,6 lb 181,8 kg - 400,8 lb	
POWER / RATINGS (208/240 V, 60 HZ)			
KW/Amps rating at 120-240V, 60Hz		20.3 kW - 84.6 A	
KW/Amps rating at 120-208V, 60Hz		17.6 kW - 84.6 A	
Cable + Plug Cable length		Nema 14 - 50P 51" (1300 mm)	
INSTRUCTIONS FOR USE			
Use & Care Manual - Installation Manual		EN, SP, FR	

SOFIA 48" PRO INDUCTION RANGE - ALL GLASS

F6PIR487S1

DIMENSIONS - CUTOUT REQUIREMENTS

Dimensions in brackets are in millimeters

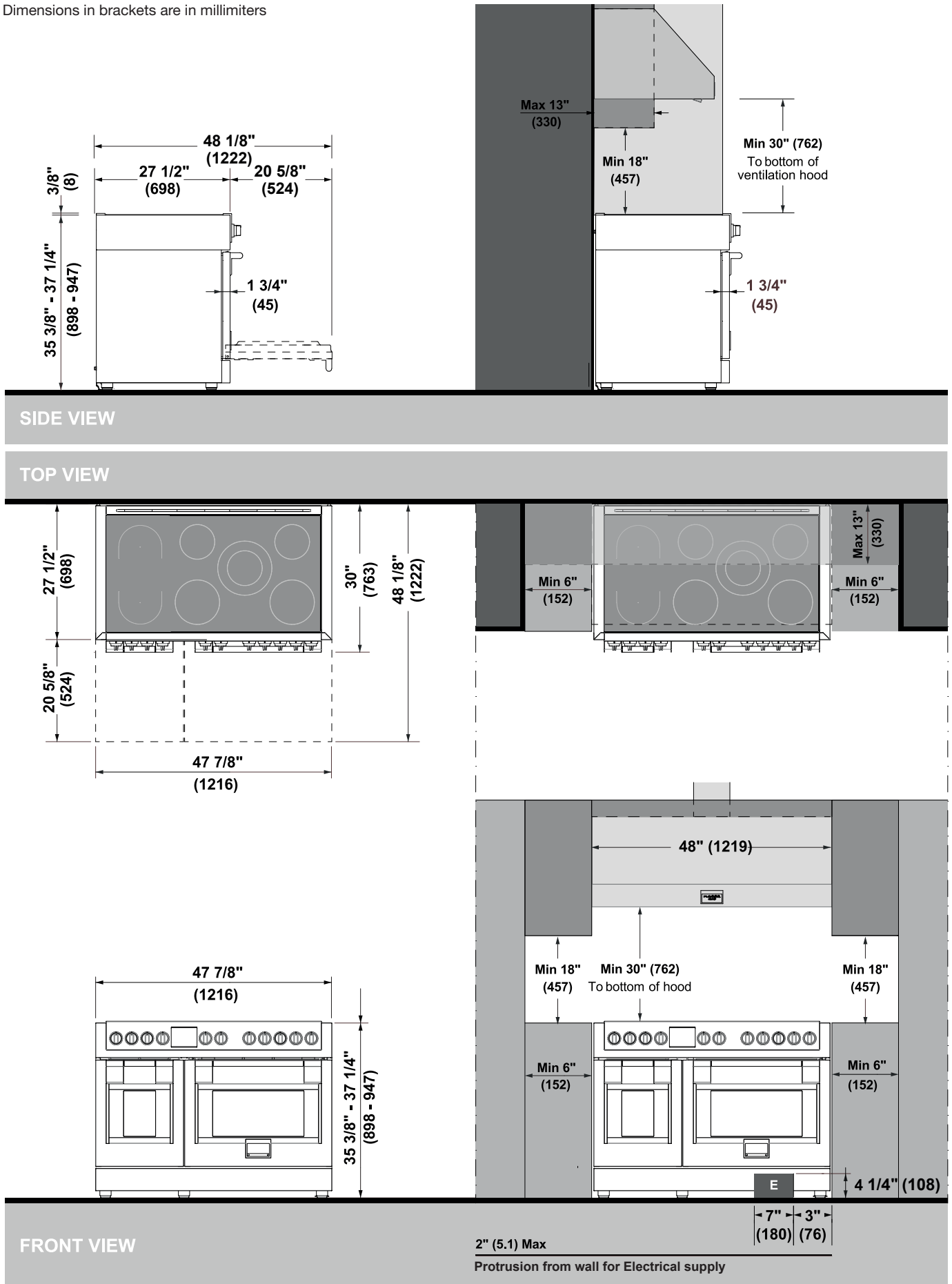

INSTALLATION REQUIREMENTS

For detailed installation specifications consult the installation requirements page or each single product installation manual.

Ensure your installation also complies with local and national building and fire codes.

FLUSH ISLAND TRIM INSTALLATION

For island installation, maintain 2-1/2 inch minimum from cutout back edge of countertop and 3 inch minimum from cutout to side edges of countertop (see view).

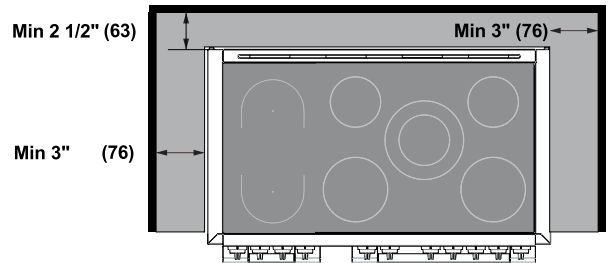

ELECTRICAL REQUIREMENTS

ELECTRICAL SUPPLY	SERVICE	POWER CONNECTION
120/240 V - 60 Hz 20.3 kW 84.6 A*	50 Ampere dedicated circuit	NEMA 14-50P
120/208 V - 60 Hz 17.6 kW 84.6 A*		

POWER MANAGEMENT SYSTEM

Power Management Area

A	Decreases by 4/5 Levels
B	Decreases by 1/2 Levels

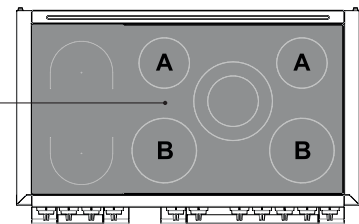

*Considering all the power consuming features of this appliance; the theoretical potential cumulative power draw could exceed the required circuit breaker rating of 50 amps. We must stress that under normal expected daily usage, the probability of this ever happening is exceptionally low. Such a power draw would require that both ovens are operating and all surface elements have been set to their maximum settings simultaneously.

This model is equipped with a Fulgor Milano proprietary Power Management System that will prevent the tripping of circuit breakers in the event of an extreme power use scenario.

The system is designed so in the event that 50 amps total draw is exceeded for several minutes, it will enter into 'POWER MANAGEMENT' mode in which case 4 of the 5 surface induction elements of the main cooking area will be temporarily reduced in their setting in accordance to the above diagram and description: the rear inductors' settings will be reduced by 4 or 5 levels and the front inductors will be reduced by 1 or 2 levels.

The amount of reduction will be determined by the current power draw at the time the system is engaged. Additionally, any active BOOST and AUTOMATIC HEAT UP functions in this region will be turned OFF to reduce power draw.

You will note that the symbol 'POWER MANAGEMENT' will illuminate on the cooking surface during this time. Functionality of the ovens and of the two left-most induction elements will remain unaffected and the central double induction element will still be able to maintain a power level setting of 9.

Once the total power draw drops below 42 amps for 30 seconds, the cooktop will return to its full operational ability and previous settings will be restored automatically except for BOOST or AUTOMATIC HEAT UP which would need to be reinitiated if so desired. Again, it is highly unlikely you will ever see the Power Management system engaged during normal daily use.

Specification sheets are for planning purposes only. Always refer to installation instructions, always consult the countertop fabricator/supplier prior to determining counter opening. Consult your HVAC engineer for your specific ventilation requirements. Always refer to installation instructions accompanying product or on available on www.fulgor-milano.com/us/en for your specific model number. Fulgor Milano retains the right to change product specifications or design without notice.