

est.

SILHOUETTE

2003

· R E S E R V E ·

UNDER COUNTER
REFRIGERATOR

INTÉGRATION SOUS LE COMPTOIR
RÉFRIGÉRATEUR

USE & CARE GUIDE

GUIDE D'UTILISATION ET D'ENTRETIEN

SINGLE ZONE ALL REFRIGERATOR

Detailed View

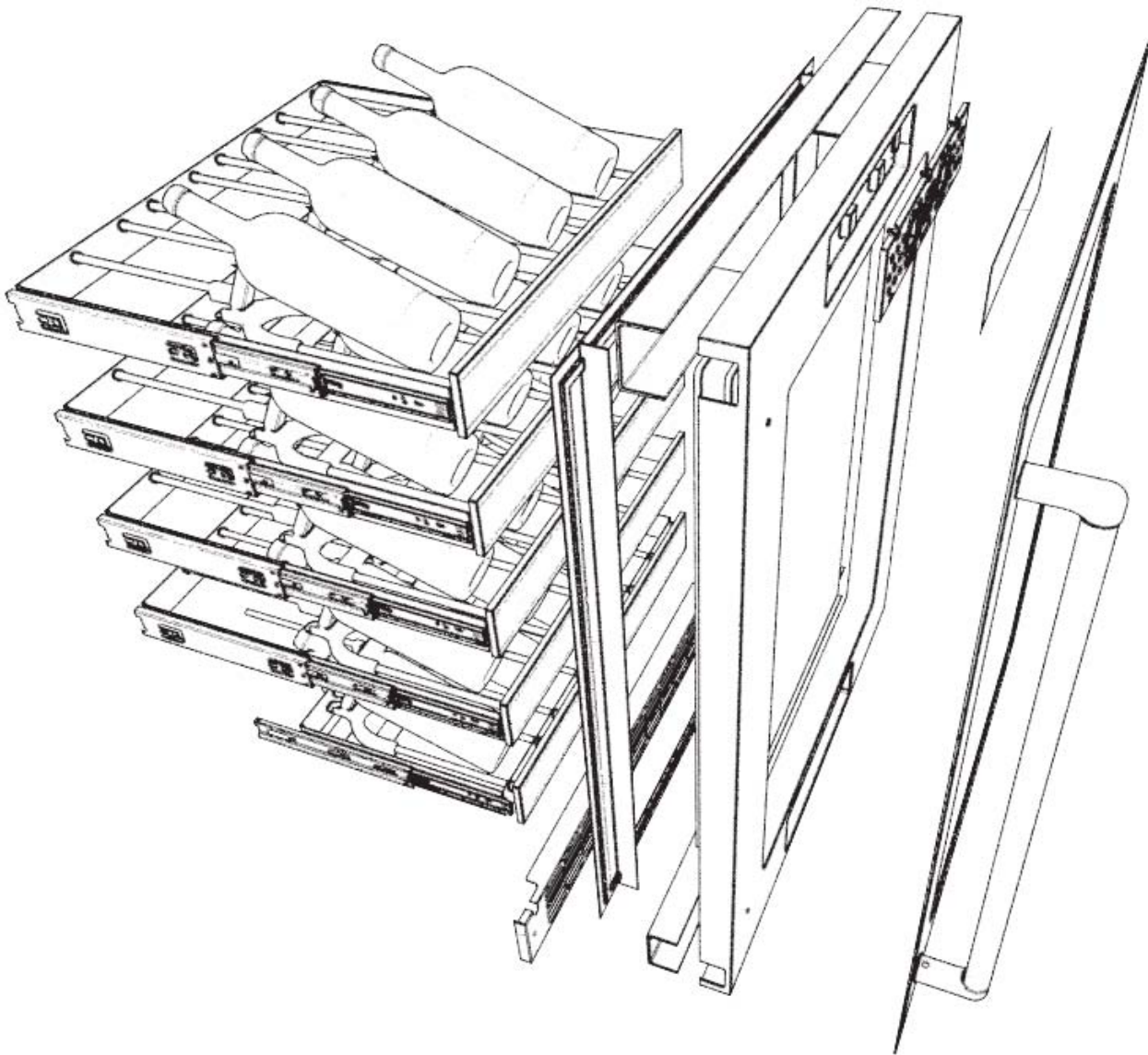

Table of Contents

Welcome	3
Important Safety Instructions	4
Safety Requirements	4
Grounding Instructions	4
Installation Guide	5
Unboxing	5
Installation Requirements	5
Anti-Tip Bracket	6
Leveling Instructions	6
Initial Set Up	7
Features	9
Temperature Display	9
Door Ajar Alarm	9
Interface Lock	9
Sabbath Mode	9
User Interface Guide	10
Menu - Primary	10
Menu - Secondary	10
Temperature Bezel	11
Lighting	11
Power	11
Varietals	11
Use & Operation	12
Wine Storage	12
Nek Prop	12
Care & Cleaning	13
Cleaning	13
Power Failure	13
Defrost	13
Vacation	13
Moving	13
Disposal	13
Troubleshooting	14
Warranty	15

Welcome,

Thank you for your purchase. We are confident that your Silhouette Reserve will provide decades of service for your family. This product is the culmination of years of research into understanding our consumer's needs and wants and then incorporating these into functional design. This premium product, for the discerning consumer, has been designed to provide visual temperature identification, superb display lighting and exceptional storage solutions.

Offering one of the strongest warranties in the business, the Silhouette Reserve offers a comprehensive two year parts and labor warranty. We also encourage consumers to take a moment to register their product via our website at www.SilhouetteAppliances.com. By doing so you can take advantage of our extended warranty offers.

Should you have any questions or concerns about the operation of this product we encourage you to call us at 1-844-455-6097. Our consumer care associates are available to answer questions Monday to Thursday between the hours of 8:30 - 6:00 pm EST and Friday between the hours of 8:30 - 4:00 pm EST.

Please take a moment to read this owner's manual to better understand the unique features this product has to offer and to maximize your enjoyment.

Enjoy!

If you require assistance,

Before you call for service, here are a few things you can do to help us serve you better.

Read this owner's manual:

It contains instructions to help you use and maintain your appliance properly.

If you receive a damaged appliance:

Immediately contact the retailer or builder that sold you the appliance.

Save time and money:

Check the troubleshooting section at the end of this manual before calling. This section will help you solve common problems that may occur.





Important Safety Information

READ AND FOLLOW ALL SAFETY INSTRUCTIONS

SAFETY REQUIREMENTS

DANGER: Risk of fire or explosion. Flammable refrigerant used. Do not puncture refrigerant tubing.

- Do not use mechanical devices to defrost refrigerator.
- Ensure that servicing is done by factory authorized service personnel, to minimize product damage or safety issues.

WARNING: Keep ventilation openings, in the appliance enclosure or in the built-in structure, clear of obstruction.

WARNING: Do not use mechanical devices or other means to accelerate the defrosting process, other than those recommended by the manufacturer.

WARNING: Do not damage the refrigerant circuit.

WARNING: Do not use electrical appliances inside the food storage compartments of the appliance, unless they are of the type recommended by the manufacturer.

CAUTION: Risk of fire or explosion. Flammable refrigerant used.

- Consult repair manual or owner's guide before attempting to service this product. All safety precautions must be followed.
- Dispose of properly in accordance with federal or local regulations.
- Follow handling instructions carefully.

CAUTION: Children should be supervised to ensure that they do not play with the appliance.

DANGER: Risk of child entrapment. Before throwing away an old appliance:

- Remove the door or lid.
- Leave shelves in place so that children may not easily climb inside.

SAFETY REQUIREMENTS

This appliance is not intended for use by persons (including children) whose physical, sensory or mental capabilities may be different or reduced, or who lack experience or knowledge, unless such persons receive supervision or training to operate the appliance by a person responsible for their safety.

GROUNDING INSTRUCTIONS

This appliance must be grounded. Grounding reduces the risk of electrical shock by providing an escape wire for the electrical current.

This appliance has a cord that has a grounding wire with a 3-prong plug. The power cord must be plugged into an outlet that is properly grounded. If the outlet is a 2-prong wall outlet, it must be replaced with a properly grounded 3-prong wall outlet. The serial rating plate indicates the voltage and frequency the appliance is designed for.

WARNING - Improper use of the grounding plug can result in a risk of electric shock. Consult a qualified electrician or service agent if the grounding instructions are not completely understood, or if doubt exists as to whether the appliance is properly grounded.

Do not connect your appliance to extension cords or together with another appliance in the same wall outlet. Do not splice the power cord. Do not under any circumstances cut or remove the third ground prong from the power cord. Do not use extension cords or ungrounded (two prongs) adapters.

If the power supply cord is damaged, it must be replaced by the manufacturer, its service agent or similar qualified person in order to avoid hazard.

SAVE THESE INSTRUCTIONS!

www.silhouetteappliances.com

INSTALLATION

Unboxing

Warning! Excessive weight hazard!

Use two persons to move and install this appliance to prevent injury.

Unpacking Instructions:

- Cut the bottom strap.
- Detach the box from the front, back and sides.
- Using two or more persons, slide the box up and off the appliance.
- Remove the plastic bag.
- Using two or more persons, lift the appliance off of the foam base.
- Recycle all packing materials.

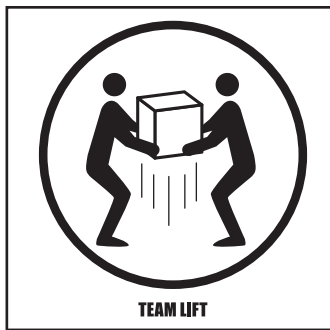

Installation Requirements

Selecting the proper location will ensure excellent performance levels for your appliance. Choose a location where the appliance will not be exposed to direct sunlight or heat emitting sources such as a heater or stove.

It is not recommended to install this appliance into a corner or directly beside a wall. This is to allow the appliance to have a greater than 90° door opening.

This appliance is front breathing. Do not block the front air vent as this will result in high operating temperatures, poor system performance and higher energy usage.

This appliance is designed for indoor use only.

The listed depth requirement in the below image is assuming that the electrical outlet is located in the adjacent cabinetry or is flush mounted on the rear wall.

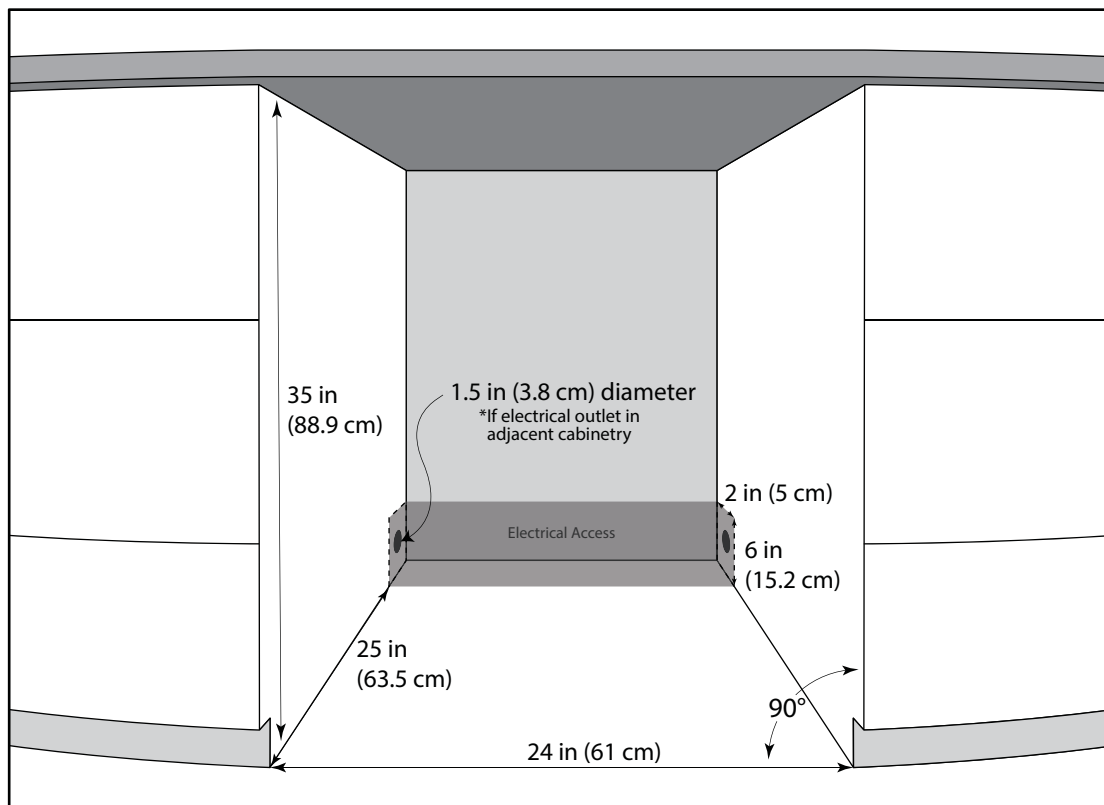

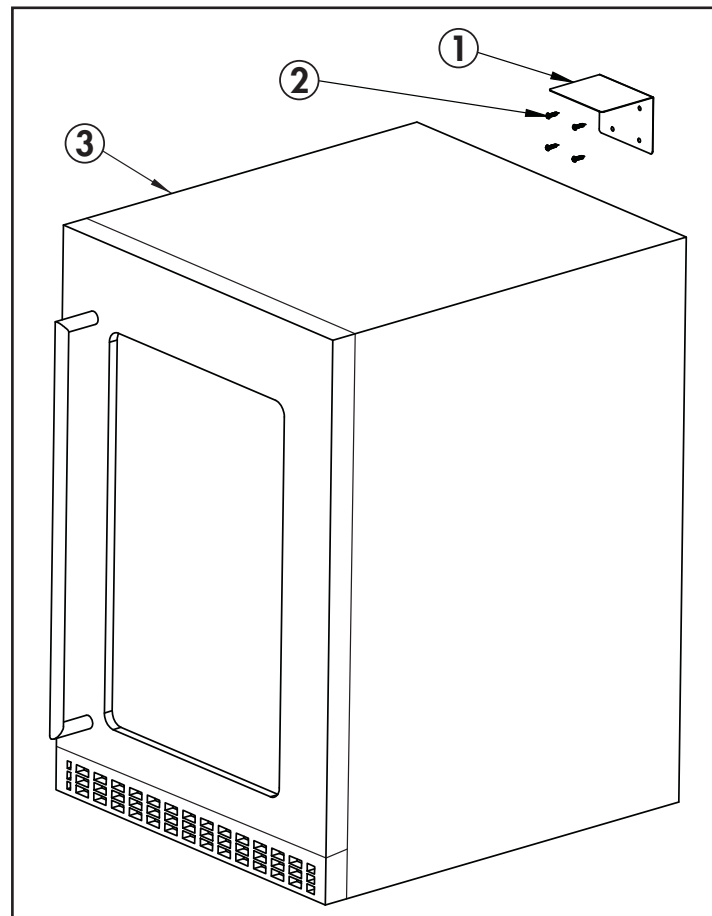

- 1. Anti-Tip Bracket
- 2. Screws
- 3. Cabinet

Anti-Tip Bracket Installation

This appliance is intended for built in application. If the appliance will be used in a freestanding application, the anti-tip bracket must be installed to avoid personal injury, damage to the appliance or loss of contents. If the appliance is not anchored, fully loaded wine racks that extend 100% will cause the unit to tip forward and create a dangerous condition.

Place the appliance against the wall in its final install location. Place the anti-tip bracket on the back of the appliance with one side of the bracket against the wall. Mark the location of the anti-tip bracket with a pencil and remove the appliance. Attach the bracket to the wall with the provided screws and wall anchors. Place the appliance under the installed anti-tip bracket. The fit should be tight to the appliance. Check the soundness of the installation by applying pressure to the cabinet, ensuring that the appliance does not tip.

Leveling Instructions

Ensure that the appliance is placed in its final location. Turn the two leveling legs on bottom of the cabinet to the right to lower the appliance and to the left to raise the appliance.

It is recommended on first installation to turn both leveling legs to the right as far as they will go, until the top of the feet are touching the bottom of the cabinet. Then, gradually turn both feet to the left until the appliance is level and at the appropriate height.

Once complete, open the door of the appliance and make sure that the shelves are able to move freely.

INITIAL SETUP

1. Plug in the appliance

Position the appliance as close to the cabinet opening as possible while still providing access to the power outlet. The power cord is 5.3' (1.6 m) long and will provide enough slack to plug in the appliance before moving it into the cabinet cut out. It is recommended to place the power outlet in adjacent cabinetry to allow easy access to the power outlet.

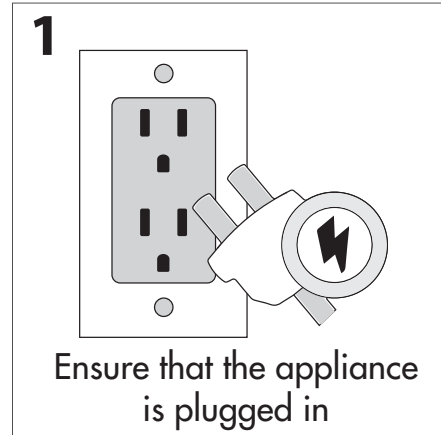

2. Confirm power

The Silhouette logo in the center of the door will illuminate to indicate that the appliance is receiving power. This logo is part of the capacitive touch interface.

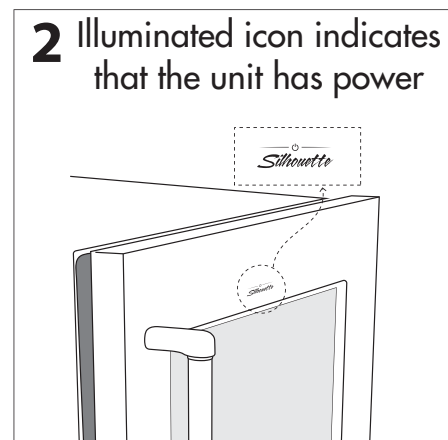

3. Turn the appliance on

Touch and hold the Silhouette logo for three seconds. The interface will count down from three and will then display "on", accompanied by an audible beep. This indicates that the appliance is turned on and is ready to begin initial set up procedures.

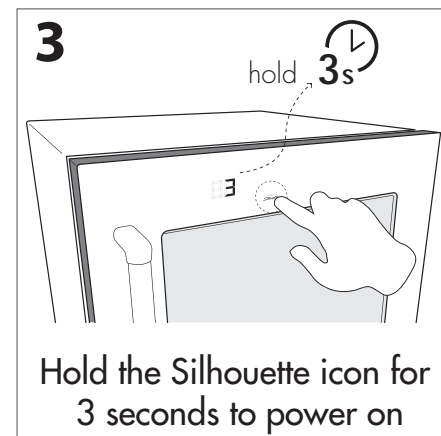

4. Initiate Setup

Initial setup is only required the first time the appliance is plugged in. Once completed, initial setup will not need to be redone in the event of a power failure. The appliance only advances to operation mode once setup is complete.

During the setup procedure, a flashing icon indicates that the user should interact with that icon to advance the setup steps.

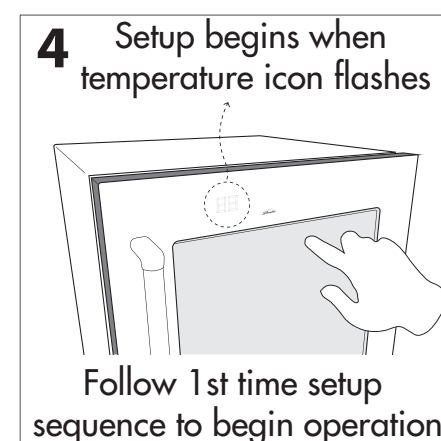

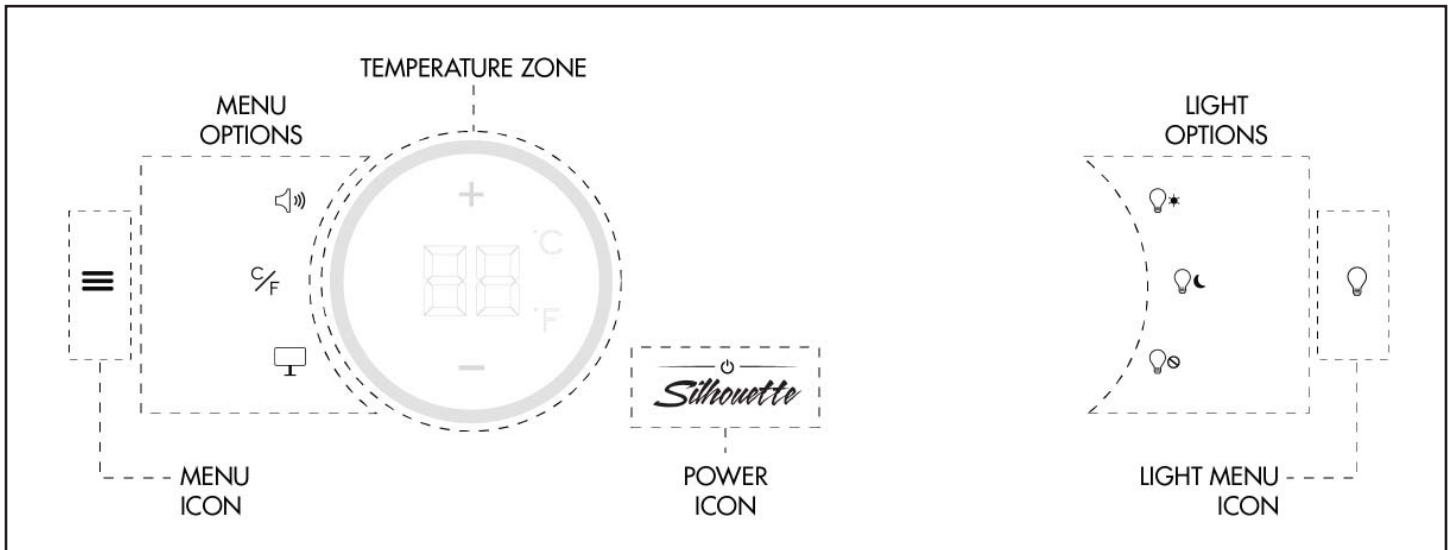

5. Initial setup procedure

Temperature Zone

The temperature zone icon will flash, displaying "00". Touch the "+" and "-" icons to increase or decrease the set temperature in 1° increments. When the desired temperature is selected, touch the temperature display to confirm the selection.

The temperature can be set between 41°F - 68°F (5°C - 18°C).

The illuminated temperature ring will change colour depending on the temperature selected. There are three temperature zone settings: Cellar, Cool and Cold.

Primary Menu

Audio

The audio icon will flash. Touch the audio icon once to maintain audible prompts and the icon will be 100% illuminated. Touch the audio icon a second time to silence audible prompts and the icon will be 50% illuminated.



Temperature Scale

The temperature scale icon will flash. Touch this icon to toggle between Fahrenheit and Celsius temperature scales. Depending on the selected scale, a "C" or an "F" will illuminate beside the temperature readout inside the ring.



Display Settings

The display interface can be set to continuous illumination or it can be turned off. When the display icon is flashing, touch it once to set the display to "on" and the icon will illuminate at 100%. Touch this icon again to set the display to "off" and the icon will illuminate at 50%.

If the display is set to "off", the icons required for the setup procedure will remain active at 50% illumination until the setup is complete, at which point the display will turn off until interacted with, except for the Silhouette logo, which remains illuminated at 50% to indicate that the appliance is still in operation. The display will illuminate once the door is opened and will remain illuminated for two minutes after the door is closed.



Interior Lighting

There are three light option icons which will all flash simultaneously between 50% and 100% illumination until user input is provided. Touch the desired interior lighting icon and it will change to steady illumination at 100%.



Bank Lighting

When bank lighting is chosen, the interior lights are set to 100% illumination for three hours. If the appliance receives no user input within three hours, for example if the door is not opened or the display is not touched, the lights will turn off. If the door is opened or the display is interacted with, the lights will turn on and remain on for three hours, again turning off if the appliance receives no user input within that time. Any time the appliance receives user input, the three hour counter restarts.



Theater Lighting

When theater lighting is chosen, the interior lights are set to 35% illumination for two minutes before turning off. If the door is opened, the lights will illuminate at 100% for as long as the door is open. When the door is closed, the lights will fade to 35% for two minutes before automatically turning off.



Energy Saving Mode

When energy saving mode is chosen, the interior lights will remain off until the door is opened. If the door is opened, the lights will illuminate at 100% for as long as the door remains open. When the door is closed, the lights will turn off.

6. Ready for operation

The appliance is now set and ready for operation. The initial setup procedure is only required the first time the appliance is plugged in and will not be required again if the appliance loses power or is unplugged.

To adjust settings in future, touch the Silhouette logo to activate the menu icon and then follow the steps necessary to adjust the desired setting through the primary or secondary menu options.

Temperature Display

The temperature display is a rolling average algorithm of the actual temperature inside the appliance. The temperature readout will only display set temperature when the user is adjusting the zone.

Door Ajar Alarm

To mitigate any excessive temperature swings or energy usage as a result of the door being left open, this appliance comes equipped with a door ajar alarm. In the event the door is left open for more than 5 minutes, the temperature rings will turn red and flash. If the audio prompts are active it will also beep. To stop the alarm, ensure the door is completely closed.

Interface Lock

The display interface can be locked so that options cannot be changed accidentally. To set the interface lock, touch and hold the menu icon for three seconds to open the secondary menu, then touch the lock icon and then touch the flashing menu icon to confirm. Once set, the small lock icons will illuminate inside the colored temperature rings. To unlock the interface, touch and hold the menu icon for 3 seconds, then touch the lock icon and touch the flashing menu icon to confirm.

Sabbath Mode

When activated, Sabbath mode allows the refrigeration system to continue to operate but the interior lighting, interface display and any audible sounds are disabled. Only the Sabbath icon, the power mode icon and the Silhouette logo will be illuminated.





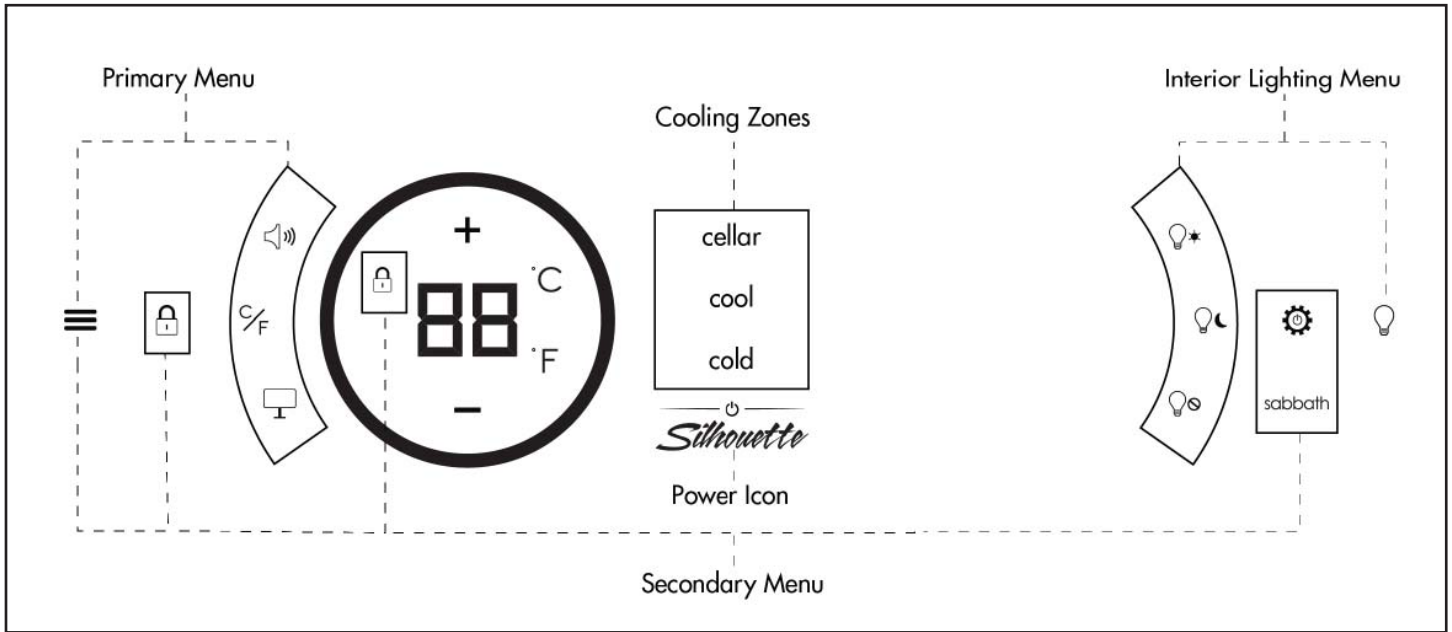







To engage, touch and hold the menu icon for three seconds to open the secondary menu. Touch the Sabbath icon. The power mode icon and menu icon will illuminate 100% and the rest of the display will turn off. Touch the flashing menu icon to confirm.

To deactivate Sabbath mode, touch and hold the menu icon for three seconds to open the secondary menu. Touch the Sabbath icon to deactivate the setting and touch the flashing menu icon to confirm.



MENU - PRIMARY		
	Menu Icon	This is the menu icon. When touched once, three options appear that the user can adjust according to their needs.
	Audio Icon	Touch this icon to turn the audio on or off. To adjust the audio setting, touch this icon once and then touch the flashing menu icon.
	Display Icon	This icon toggles the interface display. To adjust the display setting, touch this icon once and then touch the flashing menu icon.
	Temperature Scale Icon	This icon toggle the temperature scale between Celsius and Fahrenheit. The appliance will be pre-set to Fahrenheit. To change the temperature scale, touch this icon once. To set this selection touch the flashing menu icon.
MENU - SECONDARY		
	Menu Icon	Touch and hold the menu icon for three seconds to reveal secondary menu options.
	Interface Lock Icon	Touch this icon once to lock the interface. Settings cannot be changed while the interface lock is engaged. Touch this icon a second time to unlock the interface.
	Power Mode Icon	This icon illuminates when the appliance is set to a secondary menu option such as Sabbath mode.
sabbath	Sabbath Mode Icon	Touch this icon once to activate Sabbath mode. To disable Sabbath mode, touch and hold the menu icon for 3 seconds, then touch the Sabbath icon and touch the flashing menu icon to confirm.

USER INTERFACE GUIDE

TEMPERATURE DISPLAY		
	Change or set temperature	Touch this icon to show set temperature. To change the set temperature, touch this icon and use the "+" and "-" icons to adjust the setting.
	Increase set temperature	Touch this icon to increase the set temperature. Touch and hold this icon to quickly increase the set temperature. Touch the temperature readout to confirm the new setting.
	Decrease set temperature	Touch this icon to decrease the set temperature. Touch and hold this icon to quickly decrease the set temperature. Touch the temperature readout to confirm the new setting.
	Celsius scale	This icon indicates that the Celsius temperature scale is being displayed.
	Fahrenheit scale	This icon indicates that the Fahrenheit temperature scale is being displayed.
	Temperature colour ring	The colour of the ring surrounding the temperature bezel reflects the set temperature. The ring colour corresponds to the respective varietal colour.
	Lock icon	This icon indicates that the interface has been locked.
LIGHTING		
	Interior lighting menu	Touch this icon once to activate the lighting menu. Three options appear that the user can adjust according to their needs.
	Bank lighting	This setting will set the interior lights to their brightest setting for three hours. After three hours without interaction, the lights will turn off.
	Theatre lighting	This setting will set the interior lights to a dim setting for three minutes. After three minutes without interaction, the lights will turn off.
	Energy Saving Mode	This setting will set the interior lights to be off. For accessibility reasons, interior lighting will turn on at their brightest setting for the duration of two minutes any time the door is opened.
POWER		
	Power icon	Touch this icon once to activate the menu icon. Touch and hold this icon for three seconds to turn the appliance on or off.
COOLING ZONES		
	Cellar	Temperature settings between 41°F - 44°F (5°C - 7°C)
	Cool	Temperature settings between 37°F - 40°F (3°C - 4°C)
	Cold	Temperature settings between 33°F - 36°F (0°C - 2°C)

Optimized Storage

The interior chamber and shelf spacing has been designed in such a way as to optimize the storage capacity of the refrigerator. The distance between the shelves and the depth of the shelves have all been carefully considered to provide an excellent user experience.

Shelving

The Silhouette Reserve refrigerator comes equipped with two full depth and one half depth, tempered glass, adjustable shelves. The half depth shelf creates open space and permits taller beverages to be stored in front of the lower shelf.

The wine shelf in the bottom of the cabinet will store up to five bottles of wine and is designed with a pitch that allows the cork to remain moist while the label remains easy to read.

Stak Storage System

The Stak storage system is a scalloped tray which is designed to be placed at the back of a shelf. The Stak can store bottles or cans stacked on top of each other horizontally, while keeping the base stable so that the bottles or cans do not slide or roll.

The Stak is 5 inches (12.7 cm) deep, which allows storage at the front of the shelf in front of the Stak.

The Stak is not secured in place and can be stored on any shelf according to individual user needs.

Cleaning

Ensure the appliance is unplugged before cleaning.

- To clean the inside of the appliance, use a soft cloth and a solution of a tablespoon of baking soda to one quart of water or a mild soap solution or some mild detergent.
- Clean the outside with a soft, damp cloth and some mild detergent.
- It is important to keep the area clean where the door seals against the cabinet. Clean this area with a soapy cloth. Rinse with a damp cloth and let dry.

Note: Do not use cleaners containing ammonia or alcohol on the appliance. Ammonia or alcohol can damage the appearance of the appliance. Never use any commercial or abrasive cleaners or sharp objects on any part of the appliance.

Power failure

Most power failures are corrected within a few hours and should not affect the temperature of your appliance if you minimize the number of times the door is opened. If the power is going to be off for a longer period of time, take the proper steps to protect your contents.

Note: Wait 3 to 5 minutes before attempting to restart the appliance if operation has been interrupted.

Defrost

This appliance is equipped with an automatic defrost function and does not require manual defrosting. Defrost water from the appliance is channeled into a drip tray located above the compressor. Heat transfer from the compressor causes the defrost water to evaporate.

Vacation

- **Short vacations:** Leave the appliance operating during vacations of less than three weeks.
- **Long vacations:** If the appliance will not be used for several months, remove all items and turn off the appliance. Clean and dry the interior thoroughly. To prevent odor and mold growth, leave the door open slightly, blocking it open if necessary.

Moving

- Remove all items.
- Turn the adjustable legs up to the base to avoid damage.
- Tape the door shut.
- Be sure the appliance stays secure in the upright position during transportation. Also protect the outside of the appliance with a blanket or similar item.
- If the appliance is placed on its back or side during transportation, upon reaching the destination, allow it to remain upright for 6 hours before plugging in to avoid damage to the internal components.

Disposal

This appliance may not be treated as regular household waste, it should be taken to the appropriate waste collection point for recycling of electrical components. For information on local waste collection points, contact your local waste removal agency or government office.

Silhouette Consumer Care: 1-844-455-6097

Hours of operation:

Monday to Thursday 8:30 am - 6:00 pm Eastern Standard Time

Friday 8:30 am - 4:00 pm Eastern Standard Time

Information in this manual is subject to change without notice.

PROBLEM	POSSIBLE CAUSE
No power	<ul style="list-style-type: none">• A fuse may be blown or the circuit breaker tripped• Plug not fully inserted into the wall outlet
Internal temperature not cold enough Appliance runs continuously	<ul style="list-style-type: none">• Door is not shut properly or opened excessively• Exhaust vent is obstructed• Recently added a large quantity of warm bottles to the cabinet• Close proximity to heat source or direct sunlight• Ambient temperature or humidity is very high• Possible system leak, evaporator fan failure or compressor failure
Condensation on the cabinet or door	<ul style="list-style-type: none">• Door is not shut properly or opened excessively• Ambient temperature or humidity is very high

Silhouette

LIMITED "IN HOME" WARRANTY

This quality product is warranted to be free from manufacturer's defects in material and workmanship, provided that the unit is used under the normal operating conditions intended by the manufacturer.

This warranty is available only to the person to whom the unit was originally sold by Danby Products Limited (Canada) or Danby Products Inc. (U.S.A.) (hereafter "Danby") or by an authorized distributor of Danby, and is non-transferable.

TERMS OF WARRANTY

Plastic parts are warranted for thirty (30) days from the date of purchase, with no extensions provided.

First 24 months During the first **twenty four (24) months**, any functional parts of this product found to be defective, will be repaired or replaced, at warrantor's option, at no charge to the original purchaser.

To obtain service Contact the dealer where the unit was purchased, or contact the nearest authorized Danby service depot, where service must be performed by a qualified service technician. If service is performed on the unit by anyone other than an authorized service depot, all obligations of Danby under this warranty shall be void.

Boundaries of in-home service Danby reserves the right to limit the boundaries of "In Home Service" to the proximity of an authorized service depot. Any appliance requiring service outside the limited boundaries of "In Home Service", will be the consumer's responsibility to transport at their own expense to the original point of purchase or a service depot for repair. If the appliance is installed in a location that is **100 kilometers (62 miles)** or more from the nearest service center, it must be delivered to the nearest authorized Danby Service Depot by the purchaser.

Transportation charges to and from the service location are not protected by this warranty and are the responsibility of the purchaser.

Nothing within this warranty shall imply that Danby will be responsible or liable for any spoilage or damage to food or other contents of this appliance, whether due to any defect of the appliance, or its use, whether proper or improper.

EXCLUSIONS

Save as herein provided, by Danby, there are no other warranties, conditions, representations or guarantees, express or implied, made or intended by Danby or its authorized distributors and all other warranties, conditions, representations or guarantees, including any warranties, conditions, representations or guarantees under any Sale of Goods Act or like legislation or statute is hereby expressly excluded. Save as herein provided, **Danby shall not be responsible for any damages to persons or property, including the unit itself, howsoever caused or any consequential damages arising from the malfunction of the unit and by the purchase of the unit, the purchaser does hereby agree to indemnify and hold harmless Danby from any claim for damages to persons or property caused by the unit.**

GENERAL PROVISIONS

No warranty or insurance herein contained or set out shall apply when damage or repair is caused by any of the following:

- 1) Power failure.
- 2) Damage in transit or when moving the appliance.
- 3) Improper power supply such as low voltage, defective house wiring or inadequate fuses.
- 4) Accident, alteration, abuse or misuse of the appliance such as inadequate air circulation in the room or abnormal operating conditions (ie. extremely high or low room temperature).
- 5) Use for commercial or industrial purposes (ie. If the appliance is not installed in a domestic residence).
- 6) Fire, water damage, theft, war, riot, hostility, acts of God such as hurricanes, floods etc.
- 7) Service calls resulting in customer education.
- 8) Improper Installation (ie. Building-in of a free standing appliance or using an appliance outdoors that is not approved for outdoor application, including but not limited to: garages, patios, porches or anywhere that is not properly insulated or climate controlled).

Proof of purchase date will be required for warranty claims; retain bills of sale. In the event that warranty service is required, present the proof of purchase to our authorized service depot.

Warranty Service
In Home

Danby Products Limited
PO Box 1778, Guelph, Ontario, Canada N1H 6Z9
Telephone: (519) 837-0920 FAX: (519) 837-0449

1-844-455-6097
04/17

Danby Products Inc.
PO Box 669, Findlay, Ohio, U.S.A. 45840
Telephone: (419) 425-8627 FAX: (419) 425-8629