

RF26CG7400SR

SAMSUNG

Large Capacity 4-Door French Door 25 cu. ft.
Counter Depth Refrigerator with 4 types of ice



Signature Features

Large Counter Depth 25 cu. ft. Capacity

Store more groceries with more room to stay organized. Large 25 cu. ft. capacity fits big and bulky items and provides easy access to everything you need.

Four Ice Types

Enjoy your favorite beverage with your choice of ice. Choose cubed ice or Ice Bites™ from the Dual Ice Maker in the freezer drawer, or opt for curved or crushed ice from the external dispenser.

Modern Design

A flat-front design with low-profile door handles and recessed drawer handles fit seamlessly into your kitchen.

Available Color



Fingerprint Resistant
Stainless Steel



Large 25 cu. ft. Capacity



Refrigerator: Curved and Crushed Ice
Freezer: Cubed and Ice Bites™

Design

- Large Counter Depth Capacity of 25 cu. ft.
- Middle Drawer Ice Maker
- Premium External Filtered Water and Ice Dispenser
- High-Efficiency LED Lighting
- Gallon Door Bin
- Fingerprint Resistant Finish

Technology

- Wi-Fi Enabled
- Power Cool & Power Freeze
- Door Alarm
- Water Filter Indicator

Performance

- Four Ice Types: Crushed, Curved, Cubed and Ice Bites™
- SmartThings Energy*
- Metal Cooling
- Sabbath Mode

*Available on Android and iOS devices. A Wi-Fi connection and a Samsung account are required.



ADA Compliant

Rating



ENERGY STAR® rated:
716 kWh/yr

RF26CG7400SR

SAMSUNG

Large Capacity 4-Door French Door 25 cu. ft. Counter Depth Refrigerator with 4 types of ice

Installation Specifications

1. Measure the height, width and depth of the opening, making sure to include baseboards, molding tile, countertop overhang, etc. Check to be sure there is enough room to open the door (consider walls, islands or other obstacles when measuring).
2. Refer to illustration below to determine dimensions.
3. Allow 2.5" of clearance on hinge side of refrigerator when installing next to a wall where handle may make contact.
4. Allow 1" minimum clearance at rear for proper air circulation and water/electrical connections. Allow a 3/8" minimum clearance at sides and top for ease of installation.
5. Ensure each door and entryway in the home is wide enough for the refrigerator to be moved through easily.

For optimal usage and ability to open refrigerator doors completely, do not install next to a wall.

Please note: The following dimensions and cutout information is for planning purposes only. For complete installation details, consult manual packed with product or download manual online at samsung.com.



Dimensions

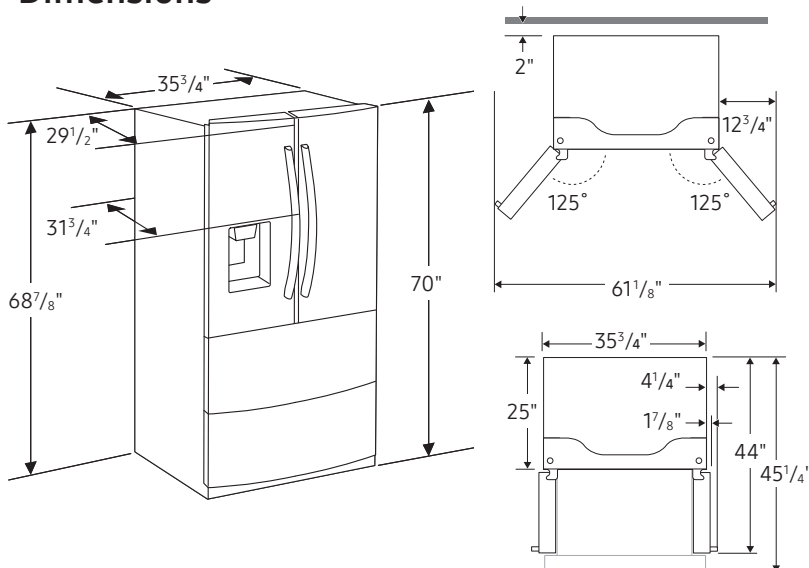

Total Capacity: 24.5 cu. ft.

Refrigerator: 17.8 cu. ft.

- External Filtered Water and Ice Dispenser (Curved Ice, Crushed Ice)
- 4 Tempered Glass Spill-Proof Shelves
- Full-Width Drawer
- 2 Clear Drawers
- 7 Door Bins
 - Right: 1 Gallon Bin, 3 Regular Bins
 - Left: 3 Regular Bins
- High-Efficiency LED Lighting

Freezer: 6.7 cu. ft.

- Dual Ice Maker in Middle Drawer (Cubed Ice, Ice Bites™)
 - 2 Removable Ice Buckets and 1 Scoop
- 1 Large Opaque Bin with 1 Divider
- High-Efficiency LED Lighting

Accessories

Water Filter: HAF-QIN

Warranty

One (1) Year Parts and Labor on Refrigerator
Five (5) Years Parts and Labor on Sealed Refrigeration System Only*
Ten (10) Years Parts and Five (5) Years Labor on Digital Inverter Compressor

*Compressor, evaporator, condenser, drier and connecting tubing.

Product Dimensions & Weight

Dimensions (WxHxD with hinges, handles and doors):
35³/₄" x 70" x 31³/₄"

Dimensions (WxHxD without hinges and door):
35³/₄" x 68⁷/₈" x 25"

Dimensions (WxHxD with hinges and doors, no handle):
35³/₄" x 70" x 29¹/₄"

Weight: 305 lbs

Shipping Dimensions & Weight (WxHxD)

Dimensions: 37³/₄" x 75¹/₄" x 31¹/₂"

Weight: 315 lbs

Color

Model #

UPC Code

Fingerprint Resistant
Stainless Steel

RF26CG7400SR 887276763873