

ACT™

	INTERNAL BLOWER STANDARD	INTERNAL BLOWER with ACT™ AIRFLOW CONTROL TECHNOLOGY™*	
Min. - Max. CFM	450 - 1,200	350 - 590	350 - 390
Min. - Max. Sones	3.5 - 9	*AIRFLOW CONTROL TECHNOLOGY™ (ACT™) is an exclusive feature built into specific Zephyr hoods which can limit the maximum blower CFM to meet local code requirements.	

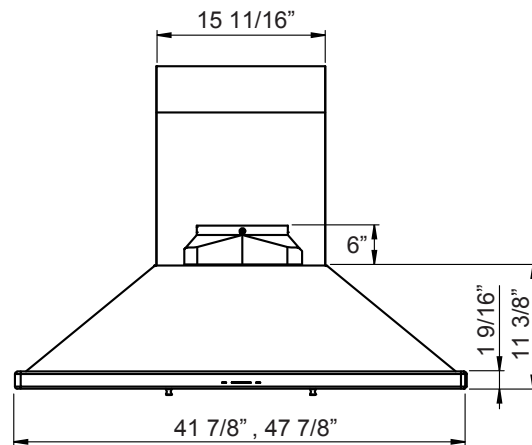

FRONT

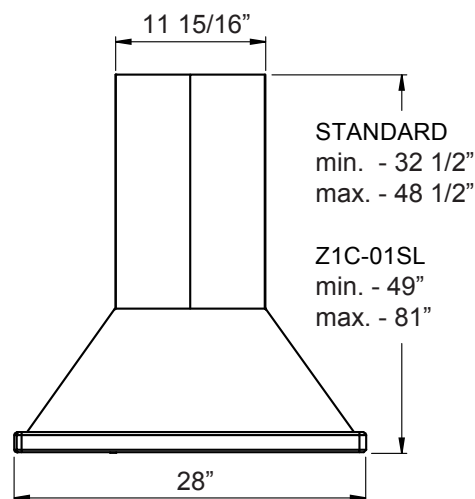

SIDE

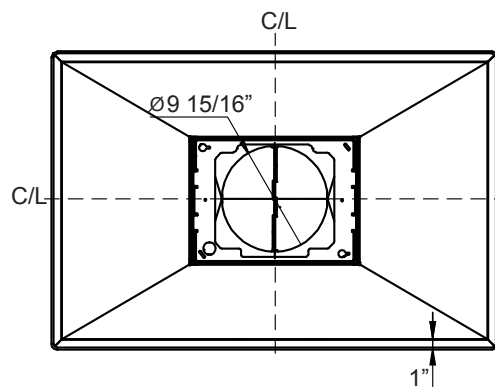

TOP

MODEL		
Stainless Steel	ZSL-E42CS	ZSL-E48CS
Size	42"	48"
BLOWER PERFORMANCE		
Blower CFM (Min. - Max.)	450 - 1,200	450 - 1,200
Sones (Min. - Max.)	3.5 - 9	3.5 - 9
ACT 590 CFM (Min. - Max.)	350 - 590	350 - 590
ACT 390 CFM (Min. - Max.)	350 - 390	350 - 390
FEATURES		
ACT™ Technology	590, 390	590, 390
Controls	ICON Touch®	ICON Touch®
Speed Levels	5*	5*
Auto Delay-Off	Yes	Yes
Lighting	LumiLight LED, 6W x4	LumiLight LED, 6W x4
Dual-Level Lighting	Yes	Yes
Filters	Hybrid Baffles x2	Hybrid Baffles x3
Recirculating Option	No	No
Quick-Lock Installation System	Yes	Yes
Magnetic Duct Covers	Yes	Yes
Extension Duct Cover Option	Yes, Up to 12' Ceiling	Yes, Up to 12' Ceiling
DUCT SPECIFICATIONS		
Vertical Internal Blower	10" Round	10" Round
Horizontal Internal Blower	NA	NA
AC POWER	120V, 60Hz at Max. 9A	120V, 60Hz at Max. 9A
OPTIONAL ACCESSORIES		
Wireless Remote Control Kit	RC-0002	RC-0002
Extension Duct Cover	Z1C-01SL	Z1C-01SL
Make-Up Air Kit	MUA010A	MUA010A
MOUNTING HEIGHT RANGE**	26" - 34"	26" - 34"
WARRANTY	3 years parts, 1 year labor	3 years parts, 1 year labor

CEILING HEIGHT		8'	8.5'	9'	9.5'	10'	10.5'	11'	12'
STANDARD DUCT COVER	Ducted Mounting Height*	26" - 27.5"	26" - 33.5"	26" - 34"	29.5" - 34"	NA	NA	NA	NA
EXTENSION DUCT COVER	Ducted Mounting Height*	NA	NA	NA	26" - 33"	26" - 34"	26" - 34"	26" - 34"	27" - 34"

*When ACT™ is enabled the maximum speed levels will change. ACT 590 CFM = 3 speeds and ACT 390 CFM = 2 speeds.
 **Mounting height refers to distance between top of a 36" tall cooking surface and bottom of hood.